



2022/23



# CATÁLOGO DE **BRINDES** PERSONALIZADOS



Fale ao vivo  
com um  
Especialista



Visite  
nosso  
Site

[eduardopersonalizados.com.br](https://eduardopersonalizados.com.br)

---

# Índice

---

 BRANVE®

20 – 25 | 108 – 111 | 160 – 165

 ekston®

60 – 69

---

06

 SUTCO®  
BRASIL

---

19

Escritório

---

59

Tecnologia

---

107

Escrita

---

159

Mochilas, Malas  
& Pastas

---

203

Pessoal & Viagem

---

229

Chaveiros  
& Lanternas

---

247

Casa,  
Restaurante & Bar

---

289

Sacolas &  
Bolsas Térmicas

---

317

Squeezes, Copos  
& Esporte

---

369

Criança  
& Escolar

---

383

Sol & Chuva

---



# Serviços de personalização de qualidade



## COMO LER AS NOSSAS DESCRIÇÕES

**Nome** — Referência do artigo

Descrição do produto.

Dimensões do produto

41 x 60 x 23 mm

Técnica recomendada + dimensão máxima

PDP - 20 x 10 mm

 Sem Personalização

 Personalização Sob Consulta



## UVC

UV CIRCULAR



Impressão UV digital aplicada a objetos cilíndricos em toda a sua circunferência.

### Materiais recomendados



## DTT

TRANSFER DIGITAL

A impressão da personalização é feita diretamente de uma impressora para o papel, que posteriormente é aplicada por meio de pressão e calor. Permite impressão a full color.

### Materiais recomendados



# STI

ETIQUETAS

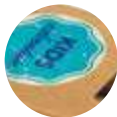

Impressão de etiquetas em vinil com qualidade fotográfica e grande variedade de tamanhos e formas.

### Materiais recomendados

- Vidro
- Metal
- Papel
- PP; ABS; PVC; Acrílico

# DGL

IMPRESSÃO DIGITAL



A impressão digital consiste em imprimir papel, com qualidade fotográfica.

### Materiais recomendados

- Papel

# SUB

SUBLIMAÇÃO



Impressão em papel da personalização por uma impressora que utilize tintas de sublimação. A transferência da tinta para o produto é feita através de pressão e calor.

### Materiais recomendados

- Metal
- Cerâmica; Porcelana

# LAS

LASER CIRCULAR



Utilização de um raio laser de grande precisão otimizado para aplicação em superfícies curvas.

### Materiais recomendados

- Cortiça
- Metal
- Madeira

# HTS

HOT STAMPING



Reprodução de personalizações através de uma prensa quente em produtos de couro ou imitação de couro. Pode ser ainda aplicada uma cor metalizada (dourado ou prateado) no molde.

### Materiais recomendados

- C. sintético
- Pele

# DUV

UV DIGITAL



Impressão da personalização numa máquina semelhante a uma impressora de cartucho em materiais. A secagem é feita através de luz ultravioleta.

### Materiais recomendados

- Vidro
- Metal
- Papel
- PP; ABS; PVC; Acrílico
- PU
- Silicone
- Madeira

# LSR

LASER



Utilização de um raio laser de grande precisão, permitindo uma gravação em baixo-relevo. Este laser pode ser de fibra ótica, adequado para metais, ou de CO2, adequado para madeiras ou cortiça.

### Materiais recomendados

- Cortiça
- Metal
- Madeira

# TRS

TRANSFER



Impressão da personalização através de uma tela para um papel, que será depois aplicada no produto por meio de pressão e calor. Recomendada para produtos não planos, como mochilas.

### Materiais recomendados

- Cortiça
- C. sintético
- Papel
- PU
- Couro reciclado
- Tecido

# SCR

SILK SCREEN



Impressão da personalização num fotolito, que é passada para uma tela de fios através de luz ultravioleta. A tinta é aplicada através de um rodo e posterior secagem.

### Materiais recomendados

- Cortiça
- Vidro
- C. sintético
- Metal
- PP; ABS; PVC; Acrílico
- Papel
- Couro reciclado
- Silicone
- Madeira

# SRC

SILK SCREEN CIRCULAR



Processo idêntico ao da silk screen mas direcionado para impressão em produtos circulares.

### Materiais recomendados

- Cortiça
- Vidro
- C. sintético
- Metal
- PP; ABS; PVC; Acrílico
- Papel
- Couro reciclado
- Silicone
- Madeira

# PDP

TAMPOGRAFIA



Técnica ideal para pequenos objetos e formas curvilíneas, a transferência de tinta é feita através de um tampão de silicone que se adapta aos mesmos.

### Materiais recomendados

- Cortiça
- Vidro
- Metal
- PU
- PP; ABS; PVC; Acrílico
- Papel
- Silicone
- Madeira

# TXP

SILK SCREEN TÊXTIL



Processo idêntico ao da silk screen, mas direcionado para impressão em produtos têxteis de grandes formatos.

### Materiais recomendados

- Cortiça
- C. sintético
- Papel
- PU
- Couro reciclado
- Tecido



**SUTCO**<sup>®</sup>

BRAZIL

**ESSÊNCIA COLORIDA**





**SU  
CO**  
BEAN



**Repita encomendas,  
receba os mesmos tamanhos**

Padronização de medidas



**Repita encomendas,  
receba as mesmas cores**

Padronização de cores



**Nunca perca uma  
encomenda**

Pronta entrega



**Poupe tempo e dinheiro**

Frete grátis



**Encomende quanto quiser**

Sem quantidade mínima

**22 cores  
4 modelos**

Já pode garantir  
a mesma **qualidade**,  
**quantidade** e **produto**  
para seus clientes  
de uma encomenda  
para outra!

**CAMISETAS  
100% ALGODÃO!**





**ESSÊNCIA COLORIDA**

## **Encontre sua Essência.**

Um dia você percebe que hoje é como ontem,  
Ontem foi igual a antes de ontem e há um mês já era assim...  
Sem saber como, a vida deixou de ter cor.  
O cinza passou a ser normal e o igual já não faz mais diferença.  
Mas preto e branco não é para você!

**Ser SUCO® é ser fresco e ter cor sem fim.**

**A doçura da fruta madura acabada de colher.**

**É apaixonar-se constantemente, por tudo e por nada.**

**E ter sabor, muito sabor!**

**É a energia de um arco íris.**

**Um samba o dia todo que não para de tocar.**

**A substância pura em tudo o que se faz.**

**É ter a complexidade do mais simples em você  
e voltar à Essência, sempre!**



SUTCO

# Papaya



## Papaya

Camiseta unissex de corte regular em malha 100% algodão (165 g/m2) com fio 30/1 misto. Com gola em ribana 1,5x1,5 com fita de reforço e com costura dupla nas mangas, barra de fundo e laterais.

**Tamanhos:** P, M, G, GG  
**TXP** - 280 x 200 mm



## Papaya Women

Camiseta feminina de corte cinturado em malha 100% algodão (165 g/m2) com fio 30/1 misto. Com gola em ribana 1x1 com fita de reforço e com costura dupla nas mangas, barra de fundo e laterais.

**Tamanhos:** P, M, G, GG  
**TXP** - 240 x 200 mm



**Papaya** 30504



**Papaya Wh** 30505



**Papaya Women** 30506



**Papaya Women Wh** 30507







# Pitanga



## Pitanga

Camiseta unissex de corte regular em malha 100% algodão (170 g/m<sup>2</sup>) com fio 30/1 penteado. Com gola em ribana 1,5x1,5 com fita de reforço e com costura dupla nas mangas, barra de fundo e laterais.

**Tamanhos:** P, M, G, GG  
**TXP** - 280 x 200 mm



**Pitanga** 30500



**Pitanga Wh** 30501



## Pitanga Women

Camiseta feminina de corte cinturado em malha 100% algodão (170 g/m<sup>2</sup>) com fio 30/1 penteado. Com gola em ribana 1x1 com fita de reforço e com costura dupla nas mangas, barra de fundo e laterais.

**Tamanhos:** P, M, G, GG  
**TXP** - 240 x 200 mm



**Pitanga Women** 30502



**Pitanga Women Wh** 30503







# Goiaba



## Goiaba

Camiseta unissex de corte regular em malha 100% algodão (135 g/m<sup>2</sup>) com fio 30/1 misto. Com gola em ribana 1,5x1,5 com fita de reforço e com costura dupla nas mangas, barra de fundo e laterais.

**Tamanhos:** P, M, G, GG  
**TXP** - 280 x 200 mm



## Goiaba Women

Camiseta feminina de corte cinturado em malha 100% algodão (135 g/m<sup>2</sup>) com fio 30/1 misto. Com gola em ribana 1x1 com fita de reforço e com costura dupla nas mangas, barra de fundo e laterais.

**Tamanhos:** P, M, G, GG  
**TXP** - 240 x 200 mm



**Goiaba** 30508



**Goiaba Wh** 30509



**Goiaba Women** 30510



**Goiaba Women Wh** 30511







# Amora



## Amora

Camiseta unissex de corte regular em malha 100% polyester fiado (135 g/m<sup>2</sup>) com fio 30/1 polyester. Com gola em ribana 1,5x1,5 com fita de reforço e com costura dupla nas mangas, barra de fundo e laterais.

**Tamanhos:** P, M, G, GG  
**TXP** - 290 x 200 mm



## Amora Women

Camiseta feminina de corte cinturado em malha 100% polyester fiado (135 g/m<sup>2</sup>) com fio 30/1 polyester. Com gola em ribana 1x1 com fita de reforço e com costura dupla nas mangas, barra de fundo e laterais.

**Tamanhos:** P, M, G, GG  
**TXP** - 240 x 200 mm



**Amora** 30512



**Amora Wh** 30513



**Amora Women** 30514



**Amora Women Wh** 30515





# Escritório



**Todos produtos BRANVE® têm as melhores certificações, como garantia de qualidade:**

- Papel FSC
- Cumprimento REACH



**EUROPEAN DESIGN**

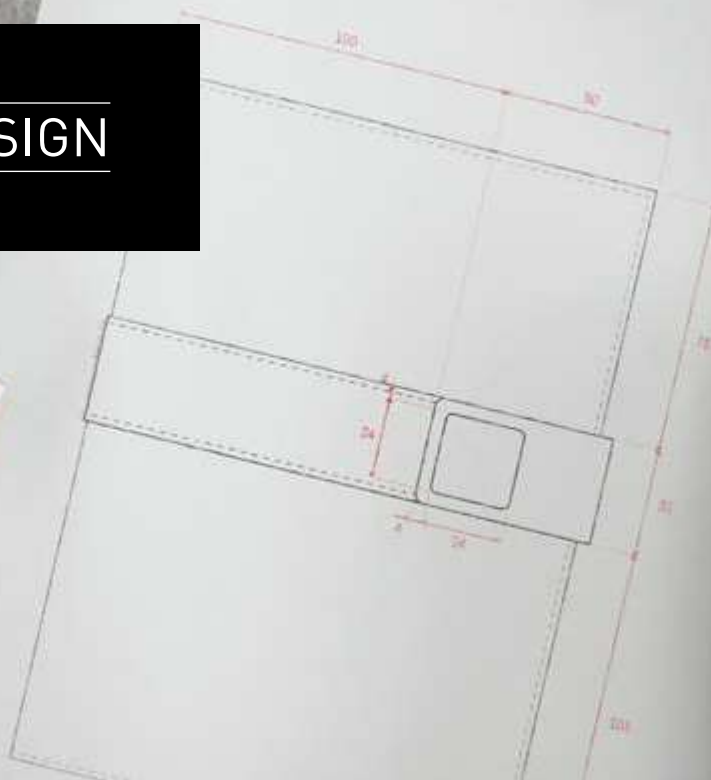



# BRANVE®

O magnetismo das personalidades fortes e a capacidade de combinar consigo. De design cosmopolita e carácter vincado, a BRANVE® é contemporaneidade e inovação. Conforto, durabilidade e elegância aliadas à praticidade – para quem procura o luxo da funcionalidade em cada detalhe.

## THE BRAND THAT MATCHES

---

**Saiba mais online**

[branve.com](http://branve.com)

**Encontre outros produtos BRANVE®**

 .108 Escrita

 .160 Mochilas, Malas & Pastas



# DYNAMIC COLLECTION

Para os dinâmicos  
com mais estilo

Encontre mais produtos DYNAMIC

 .161



2 blocos em 1

Faixa personalizável





104

 **Dynamic Notebook**  
**93597**



O DYNAMIC é um caderno A5 idealizado e desenhado para ser um objeto funcional e prático com um toque de elegância citadina. Possui dois blocos de escrita diferentes, em cada um dos lados, que podem ser utilizados e fechados, separadamente. Possui sistema de fecho com ímã na faixa que envolve o bloco. A faixa, tem uma cor diferente em cada um dos lados, permitindo a sua identificação, conferindo uma certa irreverência ao produto. O material exterior é em polípele de elevada qualidade e 1680D, texturado e plano. Possui 128 folhas que se dividem proporcionalmente em folhas não pautadas e folhas pautadas, identificáveis pela faixa exterior. O DYNAMIC torna-se único pelo seu design mas também pela sua funcionalidade, em que a dualidade o torna num objeto perfeito para todos os momentos do dia-a-dia. Fornecido em caixa presente.

 150 x 210 mm | Caixa: 200 x 30 x 265 mm

 HTS - 35 x 10 mm

# EMPIRE COLLECTION

**Exclusiva para personalidades sofisticadas**

Encontre mais produtos EMPIRE

.163



103

**A5 Empire Notebook 93598**

O EMPIRE é um caderno A5 de design moderno, minimalista e com toque business. A capa dura em couro protege o seu interior que, de forma inteligente, se divide em três partes distintas com um separador que permite identificar cada uma das partes. As suas 120 folhas dividem-se proporcionalmente por folhas não pautadas, pautadas e pontilhadas. O seu design minimalista é complementado pelo detalhe metálico no fecho, característico desta linha de produtos e que reforça a sua elegância. Produto fornecido com suporte de esferográfica (não inclusa). Fornecido em caixa presente.

150 x 210 mm | Caixa: 197 x 28 x 262 mm

LSR - 15 x 15 mm



Fecho metálico personalizável

3 tipos de páginas



# INKUOTE COLLECTION

Para aqueles que não dispensam escrever em papel

Encontre mais produtos INKUOTE

 .108



103

A5 **Geometric Notebook**  
93596



O GEOMETRIC é um caderno A5 com capa dura em c. sintético e com 128 folhas pautadas. O design de sua capa foi inspirado em figuras geométricas baseadas em padrões de ilusão ótica. A banda elástica, que permite fechar o caderno, o marcador de livros e o suporte de esferográfica (não inclusa) reforçam a utilidade deste caderno. Mais do que um caderno, é um suporte para comunicação de emoções. Algo muito pessoal e único. Fornecida em caixa presente.

140 x 210 mm | Caixa: 175 x 25 x 265 mm

HTS - 40 x 30 mm



**INKUOTE  
COLLECTION**



103

**A5 Tiles Notebook  
93737**

O TILES é um caderno A5 com capa dura em c.sintético com 128 folhas pautadas no seu interior. Todo este bloco foi idealizado com base em elementos culturais, neste caso concreto os azulejos portugueses. A banda elástica que permite fechar o caderno, o marcador de livros e o suporte de esferográfica (não inclusa), reforçam a utilidade deste caderno. Mais do que um caderno, é um suporte para comunicação de emoções. Algo muito pessoal e único. Fornecido em caixa presente.

140 x 210 mm | Caixa: 175 x 25 x 265 mm

HTS – 85 x 30 mm





Papel proveniente de uma gestão florestal sustentável

## Fibra de palha

Uma combinação que respeita o meio ambiente e reforça o compromisso com a sustentabilidade.

160



Placa em metal para personalização a laser



**ECÓlogic**

**Neruda** — 93275

Caderno A5 com capa dura em palha natural. Incluso uma placa em metal, própria para personalização, para adicionar à capa. Contém 96 folhas pautadas em papel cor marfim proveniente de gestão florestal sustentável. Fornecido em envelope de cartão.

150 x 210 mm | Placa: 30 x 15 mm

LSR – 25 x 10 mm

104

103



Combinação de materiais: palha e algodão



**ECÓlogic**

**Rousseau** — 93268

Caderno A5 com capa dura em palha e algodão canvas. Contém 96 folhas pautadas, fita separadora, elástico e suporte para esferográfica (não inclusa).

150 x 210 mm

TRS – 100 x 110 mm





Papel proveniente de uma gestão florestal sustentável

Com bolso interior

# Pele reciclada

A pele reciclada pode ser feita a partir de móveis, roupa ou sapatos usados, bem como de sobras de pele de outros produtos.



103

111



NEW

EcoLogic



**Matisse** — 93087



Caderno A5 em couro reciclado com 96 folhas pautadas cor marfim, em papel proveniente de gestão florestal sustentável. Suporte para esferográfica (não incluída), elástico e fita separadora em preto. Contém bolso interior. Fornecido em envelope preto de cartão.



140 x 210 mm

TR5 - 85 x 120 mm





113

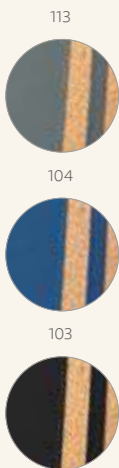

113

104

103



160



**ECÓlogic**

 **Tordo** — 93593

 Caderno A5 com capa dura em cortiça e PU e 96 folhas pautadas em cor marfim. Contém elástico, fita separadora e suporte para esferográfica (não inclusa). Fornecido em bolsa de non-woven.

↕ 140 x 210 mm

↗ HTS – 70 x 60 mm



**ECÓlogic**

 **Portel A5** — 93730

 Caderno A5 com capa dura em cortiça, 80 folhas não pautadas em cor marfim, fita separadora, elástico e suporte para esferográfica (não inclusa). Fornecido em bolsa de non-woven.

↕ 137 x 215 mm |  
Embalagem: 185 x 240 mm

↗ TRS – 100 x 180 mm



**ECÓlogic**

 **Portel A6** — 93731

 Caderno A6 com capa dura em cortiça, 80 folhas não pautadas em cor marfim, fita separadora, elástico e suporte para esferográfica (não inclusa). Fornecido em bolsa de non-woven.

↕ 97 x 145 mm |  
Embalagem: 133 x 170 mm

↗ TRS – 75 x 120 mm



160

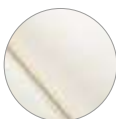

**ECÓlogic**

 **Almodovar** — 93489

 Caderno A5 em cortiça com capa dura e 80 folhas não pautadas em cor marfim.

↕ 127 x 180 mm

↗ TRS – 80 x 120 mm



160

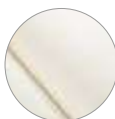

**ECÓlogic**

 **Adams A5** — 93719

 Caderno capa dura A5 em cortiça com 80 folhas não pautadas em cor marfim e fita separadora.

↕ 140 x 210 mm

↗ TRS – 110 x 180 mm



160



**ECÓlogic**

 **Adams A6** — 93720

 Caderno capa dura A6 em cortiça com 80 folhas não pautadas em cor marfim e fita separadora.

↕ 90 x 142 mm

↗ TRS – 60 x 90 mm





## Cortiça

A combinação de materiais naturais permite criar blocos únicos e sustentáveis.



Papel proveniente de uma gestão florestal sustentável



160

NEW

ECologic



**Freud** — 93578



Conjunto de bloco de notas A5 e esferográfica em cortiça. Bloco com 96 folhas com linhas pautadas cor marfim, em papel proveniente de gestão florestal sustentável. Esferográfica de escrita a azul. Fornecido em caixa presente de papel craft.



140 x 210 mm

SCR - 150 x 150 mm



## Tratamento antibacteriano

Para um ambiente de trabalho mais seguro.



NEW

 **Coben** — 93474

 Caderno A5 em PP com tratamento antibacteriano, segundo a certificação ISO22196. Contém 80 folhas pautadas em papel reciclado branco.

 140 x 213 mm

 SCR – 90 x 180 mm



# rPET + Tratamento Antibacteriano



Papel proveniente de uma gestão florestal sustentável



123

A

Tratamento antibacteriano

A



**Mondrian** — 93577

Caderno A5 em PET reciclado com tratamento antibacteriano, segundo a certificação ISO 20743. Contém 80 folhas pautadas cor marfim, em papel proveniente de gestão florestal sustentável, elástico e fita separadora.

140 x 210 mm

TR5 – 90 x 150 mm



Papel proveniente de uma gestão florestal sustentável



104

Produzido a partir de plástico reciclado



**Boyd** — 93276

Caderno A5 com capa dura em rPET. Contém 96 folhas pautadas em papel cor marfim proveniente de gestão florestal sustentável, fita separadora, elástico e bolso em papel na parte traseira da capa.

140 x 210 mm

TR5 – 80 x 120 mm



104

105

133





## Linho

O linho é um dos tecidos mais ecológicos que existe, para além disso suas fibras são duráveis e fortes.



160



103



**ECÓ**logic



**Nerval** — 93270



Caderno com capa dura em linho (230 g/m<sup>2</sup>). Cantos redondos e 96 folhas pautadas. Esferográfica não inclusa.



140 x 210 mm

TR5 - 110 x 180 mm

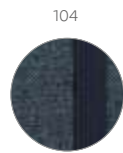
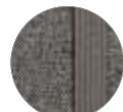
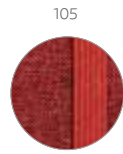

**A5 Hugo** — 93591

Caderno A5 com capa dura forrada em tecido poliéster e 80 folhas pautadas em cor marfim. Contém elástico e fita separadora.

137 x 210 mm

TR5 - 90 x 180 mm

Tecido tipo jeans

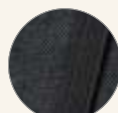
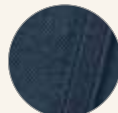
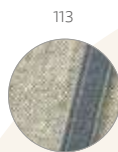

**A5 Carrey** — 93725

Caderno A5 em canvas (poliéster) com capa dura. Contém 96 folhas não pautadas em cor marfim, fita separadora, elástico e suporte para esferográfica (não inclusa). Fornecido em bolsa de non-woven.

148 x 210 mm | Bolsa: 185 x 240 mm

TR5 - 95 x 140 mm



**A5 Denim** — 93594

Caderno A5 com capa dura forrada em tecido tipo jeans e 96 folhas pautadas. Contém elástico, fita separadora, bolso interior e suporte para esferográfica (não inclusa).

140 x 210 mm

TR5 - 90 x 180 mm





123



NEW

**A5 Moraes** — 93714

Conjunto esferográfica e caderno A5. A esferográfica é em alumínio com clipe de ferro e é de mecanismo twist com escrita a azul. O caderno A5 tem capa rígida, fita separadora, elástico, bolso interior e 80 folhas pautadas de cor marfim. Conjunto fornecido em caixa de oferta.

Esferográfica: Ø10 x 138 mm |  
Caderno: 137 x 210 mm | Caixa: 190 x 240 x 30 mm

SCR – 100 x 190 mm



103

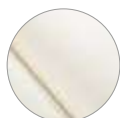

**A5 Gullar** — 93499

Kit de caderno A5 e esferográfica em cartão e alumínio. Caderno capa dura com 96 folhas não pautadas de cor marfim. Esferográfica de escrita a preto. Fornecidos em caixa almofadada.

Caderno: 137 x 210 mm |  
Esferográfica: Ø11 x 136 mm | Caixa: 190 x 240 x 30 mm

SCR – 150 x 190 mm



103



**A5 Chaucer** — 93497

Caderno A5 em c. sintético com capa dura e 96 folhas não pautadas. Incluso fita separadora, elástico e suporte para esferográfica. Incluso esferográfica de metal. Fornecida com caixa presente.

139 x 216 mm | Caixa: 145 x 220 x 15 mm

SCR – 70 x 150 mm



# Capas multifunções perfeitas para uma boa organização



**Pessoa** — 93734

Capa em tecido em poliéster, com caderno A5 removível com 80 folhas não pautadas. Com bolso interior e suporte para esferográfica (não inclusa). Fornecida em embalagem de non-woven.

160 x 220 mm | Bolsa: 205 x 250 mm  
TRS – 80 x 60 mm



• Fecho magnético



• Fecho magnético



104

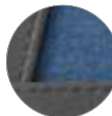

**Lispector** — 93724

Caderno A5 em c. sintético, com capa dura e fecho magnético. Contém suporte para esferográfica (não inclusa), 96 folhas não pautadas cor marfim e fita separadora. Fornecido em bolsa de non-woven.

148 x 210 mm | Bolsa: 185 x 240 mm  
TRS – 70 x 180 mm



**Russel** — 93788

Capa em c. sintético e tecido em poliéster com caderno A5 removível com 80 folhas não pautadas. Contém fecho magnético, bolso exterior, bolso interior e suporte para esferográfica (não inclusa). Fornecida em embalagem de non-woven.

155 x 215 mm | Bolsa: 205 x 250 mm  
TRS – 140 x 170 mm



**A5 Moriah — 93799**

 Caderno A5 com capa dura em c. sintético e 96 folhas pautadas. Suporte para esferográfica (não inclusa).

▮ 140 x 210 mm

➤ HTS – 80 x 40 mm

**A5 Kafka — 93712**

 Caderno A5 em c. sintético, capa dura e 80 folhas não pautadas. Contém elásticos com capacidade para suportar esferográfica (não inclusa), celular e cartões e um elástico para fechar o bloco de notas. Fornecido em bolsa de non-woven.

▮ 150 x 210 mm | Bolsa: 185 x 240 mm

➤ SCR – 35 x 160 mm

## Combine seu caderno de anotações A5 preferido com sua esferográfica de eleição e ofereça um presente totalmente exclusivo.

**Exemplos:**



**Cadernos:**

 .26 à .39



**Esferográficas:**

 .112 à .141

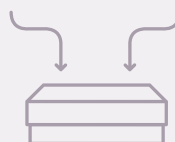

**A5 Ozma — 91972**

Caixa em cartão para 1 caderno A5 e 1 esferográfica com interior almofadado. Caderno e esferográfica não inclusos.

▮ Caixa: 190 x 240 x 30 mm

➤ SCR – 150 x 190 mm

# Para que tenha sempre onde apontar

Dos blocos mais simples aos mais originais, é importante ter onde registrar as suas melhores ideias.



Com suporte para esferográfica



A5

**Shakespeare** — 93789

Caderno A5 com capa dura em c. sintético e 140 folhas não pautadas em cor marfim. Fornecido em bolsa de non-woven. Esferográfica não inclusa.

145 x 210 mm | Bolsa: 185 x 240 mm

SCR - 80 x 150 mm



Com suporte para esferográfica



A5

**Shaw** — 93795

Kit de caderno A5 e esferográfica em c. sintético com 80 folhas não pautadas, fita separadora e elástico. Esferográfica de escrita azul. Fornecido com caixa presente em PP com elástico.

Esferográfica: Ø10 x 137 mm | Bloco: 140 x 210 mm | Caixa: 155 x 214 x 13 mm

SCR - 100 x 180 mm



# Cadernos com bolso interior e suporte para esferográfica



103



**Carre** — 93595



Caderno A5 com capa dura em c. sintético e 80 folhas pontilhadas em cor marfim. Contém elástico, fita separadora, bolso interior e suporte para esferográfica (não inclusa).

▮ 137 x 210 mm

▮ DUV — 100 x 190 mm



106

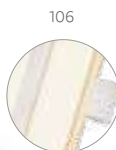

106



103



**Chamberi A5 Ln** — 93728



Caderno A5 com capa dura. Contém suporte para esferográfica, bolso interior e 80 folhas pautadas em cor marfim.

▮ 137 x 210 mm

▮ SCR — 110 x 190 mm



114



114



123



**Rodari** — 93739



Caderno A5 com capa dura e 80 folhas não pautadas em cor marfim. Contém bolso interior e suporte para esferográfica (não inclusa).

▮ 137 x 210 mm

▮ DUV — 100 x 180 mm



**B**

• **Efeito laser colorido**

Grave a laser e combine sua criatividade e combine sua criatividade com a cor do elástico! Combinações que valorizam sua marca!



**B**



105



A5

**Roth** — 93592



Caderno A5 com capa dura em PU térmico e 80 folhas pautadas. Contém elástico, fita separadora, bolso em papel na parte traseira da capa e suporte para esferográfica (não inclusa).

140 x 210 mm

LSR - 90 x 140 mm



123

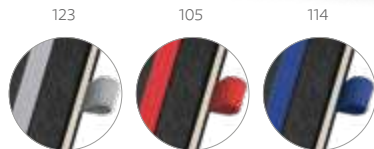

A5

**Bouvier** — 93729



Caderno A5 com capa dura. Contém suporte para esferográfica, bolso interior e 80 folhas pautadas em cor marfim.

137 x 210 mm

SCR - 120 x 190 mm



103

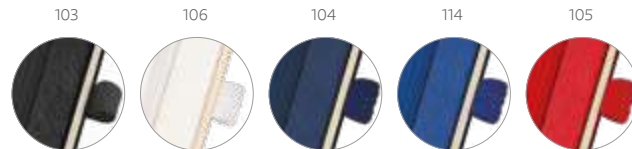

A5

**Chamberi A5** — 93491



Caderno A5 com 80 folhas não pautadas em cor marfim e capa dura. Contém bolso interior, fita separadora, elástico e suporte para esferográfica (não inclusa).

137 x 210 mm

SCR - 100 x 190 mm

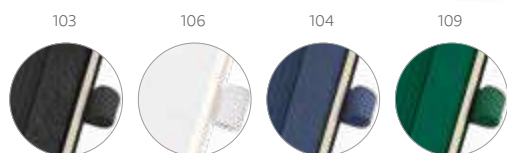
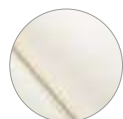

**B6 Chamberi B6 — 93727**

 Caderno B6 com capa dura. Contém suporte para esferográfica, bolso interior e 80 folhas não pautadas em cor marfim.

± 120 x 180 mm

✂ SCR – 100 x 160 mm



**A6 Chamberi A6 — 93726**

 Caderno A6 com capa dura. Contém suporte para esferográfica, bolso interior e 80 folhas não pautadas em cor marfim.

± 97 x 145 mm

✂ SCR – 70 x 130 mm



**A5 Corbin — 93717**

 Caderno A5 em c. sintético com capa dura. Contém 80 folhas pautadas, fita separadora, elástico e suporte para esferográfica (não inclusa).

± 140 x 210 mm

✂ SCR – 100 x 200 mm

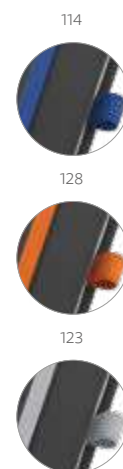

**A6 Ruiz — 93722**

 Caderno A6 com capa dura em c. sintético e 80 folhas pautadas.

± 90 x 140 mm

✂ SCR – 70 x 130 mm



## Capas fluorescentes

O caderno que precisa para dar mais brilho às suas anotações.



Folhas com borda em preto



A5 **Watters** — 93269

Caderno A5 com capa dura em PU fluorescente. Contém 96 folhas pautadas brancas com a borda em preto, fita separadora e elástico.

140 x 210 mm

TR5 – 90 x 180 mm



109

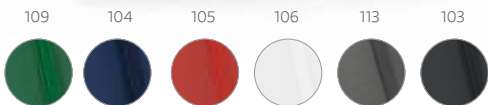

**A5 Atwood A5** — 93492  
 Caderno A5 em c. sintético com capa dura e 80 folhas não pautadas.  
 140 x 210 mm  
 SCR - 100 x 190 mm



105

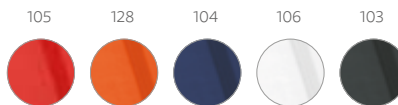

**B6 Atwood B6** — 93723  
 Caderno B6 com capa dura em c. sintético e 80 folhas não pautadas.  
 120 x 170 mm  
 SCR - 100 x 150 mm



128

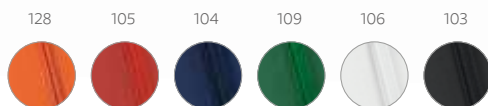

**A6 Atwood A6** — 93493  
 Caderno A6 em c. sintético com capa dura e 80 folhas não pautadas.  
 90 x 140 mm  
 SCR - 45 x 110 mm



104

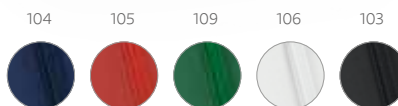

**A6 Grimm** — 93721  
 Caderno A6 com capa dura em c. sintético e 80 folhas pautadas.  
 90 x 140 mm  
 SCR - 70 x 130 mm

Um Arco-Íris  
de opções para  
tirar notas  
em qualquer  
momento do dia



pocket

**Meyer** — 93425

Caderno de bolso com 80 folhas não pautadas,  
capa dura em c. sintético, fita separadora e elástico.

90 x 140 mm

DUV – 70 x 120 mm



# Cadernos de papel reciclado com argolas



119

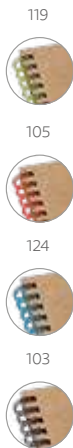

119

105

124

103

**ECÓlogic**



**Garden** — 93708

Caderno B6 espiral com 60 folhas pautadas de papel reciclado e capa dura em cartão com suporte para esferográfica (não inclusa).

140 x 180 mm

SCR — 80 x 50 mm



114

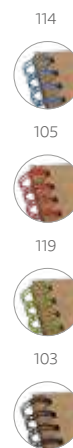

114

105

119

103

**ECÓlogic**



**Marlowe** — 93707

Caderno de bolso espiral com 60 folhas pautadas de papel reciclado e capa dura em cartão com elástico.

100 x 140 mm

SCR — 50 x 120 mm



109

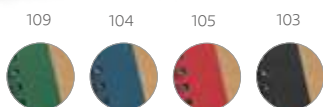

109

104

105

103

**ECÓlogic**



**Asimov** — 93715

Caderno B6 espiral com 60 folhas não pautadas de papel reciclado, capa dura em papel craft e suporte para esferográfica. Incluso esferográfica.

130 x 177 mm

SCR — 70 x 160 mm



104

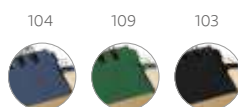

104

109

103

**ECÓlogic**



**Ringord** — 93427

Caderno de bolso espiral com 60 folhas não pautadas de papel reciclado, capa dura em cartão e suporte para esferográfica. Incluso esferográfica.

105 x 145 mm

TRS — 80 x 90 mm



119

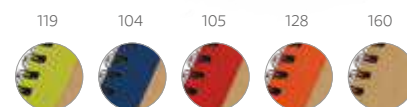

119

104

105

128

160

**ECÓlogic**



**Cornish** — 93428

Caderno A6 em cartão com capa dura e 60 folhas não pautadas de papel reciclado.

105 x 145 mm

SCR — 45 x 120 mm



## Papel pedra

- Textura suave
- Impermeável
- Resistente
- Ecológico

Conjogue o seu caderno **Rock** com a esferográfica **Beta Bamboo** na página 137.

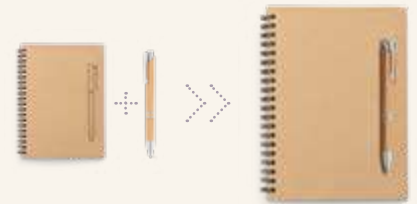

A



Capa dura em bambu

70 folhas em papel reciclado



160



160

Com suporte magnético para esferográfica

A

**ecologic**

**Dickens A6** — 93486

Caderno A6 espiral com capa dura em bambu, 70 folhas pautadas de papel reciclado e suporte para esferográfica. Esferográfica em bambu inclusa.

105 x 148 mm

LSR – 55 x 118 mm

**ecologic**

**Dickens A5** — 93485

Caderno A5 espiral com capa dura em bambu, 70 folhas pautadas de papel reciclado e suporte para esferográfica. Esferográfica em bambu inclusa.

135 x 180 mm

LSR – 85 x 140 mm

**ecologic**

**Rock** — 93419

Caderno B6 espiral com capa dura em papel craft e 70 folhas não pautadas em papel pedra de 120 g/m<sup>2</sup>. Imã na capa que funciona como um suporte de esferográfica (não inclusa).

130 x 180 mm

SCR – 70 x 160 mm



**Escolhas mais simples, mas igualmente sustentáveis.**



160



Com bolso interior

NEW

**EcoLogic**



**Kostova** — 93439



Caderno A5 com 40 folhas pautadas de papel reciclado e capa em cartão com bolso interior.



144 x 210 mm

SCR - 100 x 150 mm



129



160

104

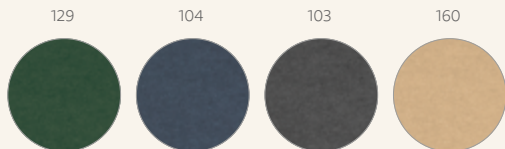

**EcoLogic**



**Ecowin** — 93495



Caderno A5 com 40 folhas pautadas e capa flexível em cartão.



140 x 210 mm

SCR - 120 x 190 mm



**EcoLogic**



**Bulfinch** — 93461



Caderno B7 com 30 folhas não pautadas de papel reciclado e capa em cartão.



93 x 125 mm

SCR - 70 x 100 mm





Folhas costuradas  
na lombada



**ECologic**

**Alcott A4** — 93272

Caderno A4 com capa em cartão (250 g/m<sup>2</sup>) e cantos redondos. Contém 40 folhas não pautadas, costuradas, em papel reciclado proveniente de gestão florestal sustentável.

210 x 300 mm

**SCR** – 130 x 180 mm



**ECologic**

**Alcott A5** — 93273

Caderno A5 com capa em cartão (250 g/m<sup>2</sup>) e cantos redondos. Contém 40 folhas não pautadas, costuradas, em papel reciclado proveniente de gestão florestal sustentável.

140 x 210 mm

**SCR** – 100 x 120 mm



**ECologic**

**Alcott A6** — 93274

Caderno A6 com capa em cartão (250 g/m<sup>2</sup>) e cantos redondos. Contém 40 folhas não pautadas, costuradas, em papel reciclado proveniente de gestão florestal sustentável.

100 x 145 mm

**SCR** – 70 x 100 mm

Incluso lápis com borracha na ponta



**ECologic**

**Bronte** — 93422  
 Caderno A7 com 70 folhas não pautadas de papel reciclado, capa dura em cartão e elástico. Incluso lápis com borracha na ponta.  
 82 x 105 mm  
 SCR – 40 x 80 mm

**ECologic**

**Flaubert** — 93709  
 Caderno de bolso com 80 folhas não pautadas de papel reciclado e capa dura em cartão. Contém elástico e fita separadora.  
 100 x 140 mm  
 SCR – 60 x 110 mm



**Lewis** — 93426  
 7 blocos adesivados com 25 folhas cada e capa em cartão.  
 80 x 105 x 9 mm  
 SCR – 50 x 80 mm

**Tazy** — 93735  
 Porta cartões em craft com elástico, acompanha 6 blocos adesivados com 22 folhas cada.  
 104 x 65 x 5 mm  
 PDP – 30 x 50 mm





A



160



160

103



160

104

103

**EcoLogic**



**Cooper** — 93791



6 blocos adesivados com 25 folhas cada. Incluso caderno com 50 folhas não pautadas e esferográfica em papel craft.



100 x 150 mm

TR5 - 70 x 90 mm

A

**EcoLogic**



**Eliot** — 93792



Kit para escritório em cartão. Composto por caderno (80 folhas pautadas em papel reciclado), 6 blocos adesivados (25 folhas cada), 1 régua de 12 cm, 1 esferográfica em papel craft e suporte para cartões de visita.



110 x 153 mm

SCR - 60 x 130 mm







A

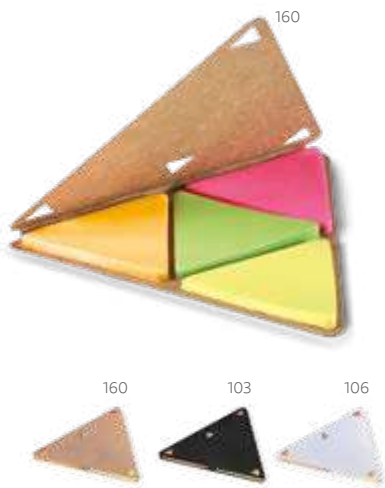

**EcoLogic**

**Faulkner** — 93794

4 blocos adesivados triangular com 25 folhas cada e com capa em cartão.

▮ 91 x 91 mm

▮ TRS - 35 x 30 mm



**EcoLogic**

**Peter** — 93718

6 blocos adesivados espiral com 25 folhas cada e capa em papel craft.

▮ 75 x 70 mm

▮ SCR - 50 x 35 mm



**Stooky** — 93421

5 blocos adesivados com 20 folhas cada.

∓ 80 x 60 x 3 mm

↗ SCR – 60 x 30 mm



**James** — 93448

7 blocos adesivados com 25 folhas cada e capa em cartão. Incluso régua de 12 cm com escala impressa.

∓ 159 x 50 x 3 mm

↗ SCR – 130 x 12 mm



**Yeats** — 53569

Porta crachá com clipe metálico com mecanismo extensível até aos 900 mm. Com presilha transparente e botão para adicionar bolsa porta-cartões. O mecanismo retrátil permite apresentar seu cartão ou credencial com segurança e comodidade.

∓ Ø32 x 9 mm

↗ PDP – 15 x 15 mm



**Milton** — 93476

 Caderno A7 espiral com 80 folhas não pautadas e capa semi-rígida em PP.

∓ 78 x 108 mm

↗ SCR – 30 x 60 mm



160

A

**ECologic**



**Serpa** — 92069



Pasta A4 em cortiça, com um bloco de 20 folhas não pautadas em cor marfim, suporte para esferográfica (não inclusa) e elástico. Fornecida em embalagem de non-woven.



239 x 307 x 17 mm | Bolsa: 285 x 350 mm

TRs - 150 x 190 mm



A



160

Esferográfica inclusa

**ECologic**



**Poe** — 92046



Pasta A4 em cartão (450 g/m<sup>2</sup>) com um bloco de 20 folhas não pautadas de papel reciclado e suporte para cartão de visita. Incluso esferográfica.



230 x 320 x 15 mm

SCR - 170 x 200 mm



160

**ECologic**



**Puzo** — 93463



Pasta porta-documentos A4 em cartão (400 g/m<sup>2</sup>) com dois bolsos no interior.

230 x 307 mm

SCR - 180 x 180 mm





• Flexível e direcionável

• Com carregador wireless

B



160

B

**ecologic**

**Lezzo** — 58517

Luminária de mesa em ABS e fibra de palha de trigo com carregador wireless. A haste é flexível para ajustar a direção da luz e contém 20 LEDs que permitem uma iluminação até 3 níveis de intensidade. No topo da luminária encontra-se um botão touch para ligar, desligar e ajustar os níveis de iluminação. O carregador sem fios é de carregamento rápido, tendo uma potência até 10W, com entradas 5V/2A e 9V/1.67A. No local onde o equipamento é colocado tem um círculo com silicone para evitar que se mova. Incluso cabo micro USB de 1 m. Fornecido em caixa presente de papel craft.

160 x 268 x 85 mm

PDP - Ø40 mm

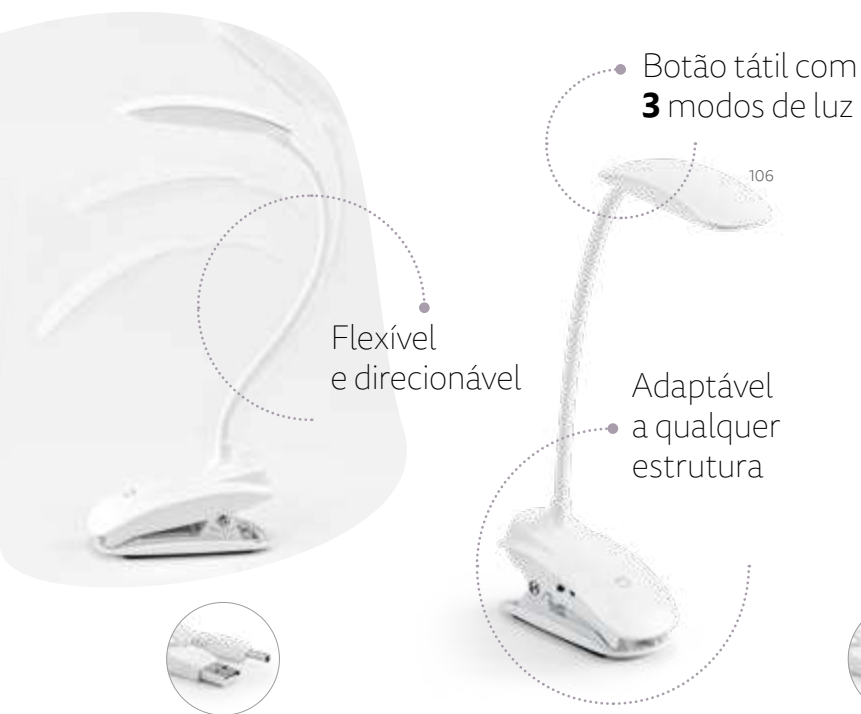

• Botão tátil com 3 modos de luz

• Flexível e direcionável

• Adaptável a qualquer estrutura

106

**Conexão com smartphone e coluna de transmissão bluetooth.**

• 18 LED's de alto brilho

106

**Nesbit II** — 54743

Luminária de mesa portátil em ABS e com LED COB. A luminária tem mola, braço flexível e botão tátil com 3 modos de luz (fraco, médio e forte). Autonomia até 20 horas. Incluso cabo USB de 1 metro para carregamento.

115 x 55 x 380 mm

PDP - 50 x 20 mm



**Graham** — 54734

Luminária de mesa com caixa de som em ABS. Com 18 LEDs de alto brilho, botão tátil e braço flexível. Transmissão por bluetooth e ligação stereo 3,5 mm com 5W/4Ω. Autonomia até 6 h e conexão à playlist do dispositivo móvel. Incluso cabo USB para carregar. Fornecida em caixa presente.

100 x 225 x 100 mm | Caixa: 110 x 235 x 105 mm

PDP - 50 x 12 mm



Bateria portátil com indicação de status de carregamento



Fecho flexível em silicone

• Suporte para celular



• Placa retroiluminada

**A5 Oscar II — 52075**

-  Pasta A5 em c. sintético com bateria portátil embutida (lítio). A bateria tem capacidade para 4.000 mAh, tempo de vida ≥ 500 ciclos com entrada/saída 5V/1A e cabo USB/micro USB para carregar a bateria. No interior, contém um caderno removível com 64 folhas pautadas de cor marfim, um suporte para esferográfica (não inclusa) e elásticos para organização e suporte para smartphone. No exterior, uma placa com acabamento emborrachado, LED interior e botão on/off. Fornecida em caixa presente.

▮ 165 x 225 x 25 mm | Placa: 55 x 35 mm | Caixa: 180 x 240 x 35 mm

➤ LSR – 30 x 25 mm



103



**A4 Christie — 92058**

-  Pasta A4 em c. sintético e microfibr com 4 argolas de 20 mm e caderno com 20 folhas pautadas. Pen drive não inclusa.

▮ 265 x 340 x 45 mm

➤ TRS – 100 x 200 mm



103



**A4 Paszo — 92044**

-  Pasta A4 em c. sintético e microfibr. A pasta contém vários bolsos interiores, um bloco de 20 folhas pautadas e suporte para esferográfica (não incluída). Placa disponível para personalização.

▮ 245 x 325 x 40 mm | Chapa: 16 x 45 mm

➤ TRS – 150 x 250 mm



- Papel proveniente de uma gestão florestal sustentável



103



**Emerge A5 Folder** — 93581

Pasta A5 em 300D rPET com carregador wireless embutido. A bateria tem capacidade para 5.000 mAh, potência de 10W, entrada/saída 5V/2.1A e cabo USB tipo C para carregar a bateria. A pasta contém no seu interior um bolso para smartphone até 6.5", três espaços para cartões, quatro luzes LED, botão on/off, suportes para esferográfica (não incluída), celular e cabo USB, um bloco de notas com capa em cartão preto e 64 folhas pautadas de cor marfim, em papel proveniente de gestão florestal sustentável. Na frente existe ainda uma impressão oval em preto para indicar a área de carga do wireless. Fornecido em caixa presente.

165 x 225 x 25 mm

PDP - 40 x 15 mm

Com carregador wireless





**A4 Bielo — 92038**

Pasta A4 em c. sintético, com bolso frontal e fecho. No interior tem vários bolsos e suporte para esferográfica (não inclusa). Contém um bloco com 20 folhas pautadas e calculadora dual-power de 8 dígitos, com pilha LR1130 inclusa.

250 x 345 x 20 mm

SCR – 130 x 130 mm



**A4 Bocage — 92045**

Pasta A4 em c. sintético e 1680D. Fecho magnético e bloco com 20 folhas pautadas. Esferográfica não inclusa.

245 x 325 x 15 mm | Chapa: 45 x 15 mm

LSR – 30 x 10 mm



**A4 Clark — 92041**

Pasta A4 em 600D com fecho elástico. A pasta contém um bloco de 20 folhas pautadas, 3 bolsos interiores e suporte para esferográfica (não inclusa).

240 x 325 x 15 mm

TRS – 180 x 100 mm

# Pastas em linho sintético



## A4 Salinger — 92068

Pasta A4 em linho sintético e c. sintético com placa metálica com acabamento emborrachado. No interior, contém um bloco (20 folhas pautadas), suporte para esferográfica (não inclusa) e outros compartimentos para acessórios (não inclusos).

259 x 336 x 27 mm | Placa: 50 x 30 mm

LSR – 40 x 25 mm



104



123



103



104

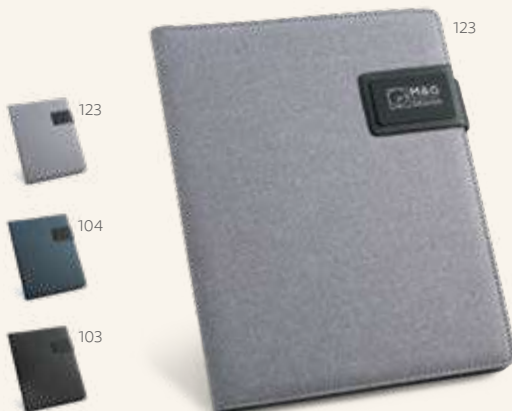

123



123



104



103



123



104



103



123



## A5 Pynchon — 92066

Pasta A5 em linho sintético e c. sintético com fecho magnético. No interior, contém um bloco (20 folhas pautadas), suporte para esferográfica (não inclusa) e outros compartimentos para acessórios (não inclusos).

183 x 252 x 18 mm | Placa: 50 x 30 mm

LSR – 40 x 25 mm



## A4 Riordan — 92067

Pasta A4 em linho sintético e c. sintético com fecho magnético. O interior contém um caderno de 20 folhas pautadas, suporte para esferográfica (não inclusa), bolso para smartphone e suportes para cabos ou outros acessórios (não inclusos). Placa metálica com acabamento emborrachado.

233 x 310 x 18 mm | Placa: 50 x 30 mm

LSR – 40 x 25 mm



124



124



105



123

**A4 Fitzgerald** — 92040

 Pasta A4 em c. sintético e 800D com o interior em microfibra. A pasta contém um elástico para fechar e no seu interior inclui um bloco de 20 folhas pautadas, 3 bolsos e suporte para esferográfica (não inclusa).

☒ 245 x 315 x 15 mm

☒ TRS - 150 x 250 mm



103

**Irulan** — 92630

Embalagem para pastas A4 em non-woven (90 g/m<sup>2</sup>).

☒ 390 x 290 mm

☒ TRS - 200 x 280 mm





**Tecnologia**







**ekston®**

**Good things are always there**

Prolongar instantes e experiências únicas através da tecnologia. A qualidade superior e a estética contemporânea da ekston® traduzem-se em produtos de performance excepcional que nos acompanham para todo o lado - uma extensão de experiências que exalta emoções e desafia os limites da tecnologia.

---

**Saiba mais online**

**[ekston.com](http://ekston.com)**





# RELÓGIOS INTELIGENTES



Inox **Thiker I**  
**57431**

103



O THIKER I é um sofisticado relógio inteligente resistente à água com bracelete em aço inox e transmissão por bluetooth 4.2 (compatível com versões iguais ou superiores Android 5.0 e iOS 9.0). O THIKER I é um aliado para o dia-a-dia através de múltiplas funcionalidades: pedômetro, acesso a notificações e conexão à playlist do dispositivo móvel, monitorização do sono, frequência cardíaca, geolocalizador, despertador, entre outras. Tem uma resolução de tela de 240 x 240 px, capacidade de 230 mAh e autonomia em uso até 72 horas e em standby até 7 dias. Fornecido em caixa presente.



┌ 26 x 47 x 8 mm | Caixa: 120 x 120 x 70 mm

└ DUV – 35 x 70 mm



**CARACTERÍSTICAS:**

- Resistente à água
- Sensor batimento cardíaco
- Monitorização do sono
- Conexão à playlist do dispositivo móvel
- Despertador
- Notificações do dispositivo móvel



**Thiker II**  
**97431**

101



O THIKER II é um moderno relógio inteligente com bracelete em c. sintético de alta qualidade, que se adequa a diferentes ocasiões devido ao seu elegante design. Com transmissão via bluetooth 4.2 (compatível com versões iguais ou superiores Android 5.0 e iOS 9.0) e várias úteis funcionalidades como: pedômetro, acesso a notificações e conexão à playlist do dispositivo móvel, monitorização do sono, frequência cardíaca, geolocalizador, despertador, entre outras. O THIKER II tem uma resolução de tela de 240 x 240 px, capacidade de 230 mAh e autonomia em uso até 72 horas e em standby até 7 dias. Fornecido em caixa presente.



┌ 26 x 47 x 8 mm | Caixa: 120 x 120 x 70 mm

└ SCR – 70 x 35 mm



**CARACTERÍSTICAS:**

- Resistente à água
- Sensor batimento cardíaco
- Monitorização do sono
- Conexão à playlist do dispositivo móvel
- Despertador
- Notificações do dispositivo móvel



**Metronome**  
**97429**

103



O Metronome é um relógio inteligente moderno e sofisticado com detalhes que lhe atribuem um design intemporal e simultaneamente inovador. Com um tela de 240 x 240 dpi e 1.3", o GPS integrado e a sua resistência à água elevam a singularidade deste relógio inteligente, tornando-se um aliado essencial no dia-a-dia. Tem ainda outras funcionalidades como o sensor de batimento cardíaco, monitorização do sono, notificações e conexão à playlist do dispositivo móvel via bluetooth 4.0 (compatível com versões iguais ou superiores Android 5.0 e iOS 9.0). Capacidade de 450 mAh e autonomia em uso até 48 horas e em standby até 7 dias. Fornecido em caixa presente.



┌ 26 x 50 x 10 mm | Caixa: 120 x 120 x 70 mm

└ DUV – 35 x 70 mm



**CARACTERÍSTICAS:**

- Resistente à água
- Sensor batimento cardíaco
- Monitorização do sono
- Conexão à playlist do dispositivo móvel
- Notificações do dispositivo móvel
- GPS integrado



# FONES DE OUVIDO



107

## Descry 97922

Os DESCRY são uns elegantes fones de ouvido wireless em metal e ABS. Suas características técnicas oferecem um objeto de elevada funcionalidade. Contêm uma transmissão por bluetooth 5.0 e têm um alcance até 10 m. Suas funcionalidades incluem: microfone, botão para atender chamadas e conexão à playlist do dispositivo móvel. O estojo de carregamento está incluso, é compatível com conector micro USB e tem uma capacidade de 500mAh. Os fones têm uma potência de 20Hz-20kHz e potência de 5mW (32Ω). A sua autonomia em uso é até 3 h e em standby até 300 h. Fornecidos em caixa presente.

∓ 31 x 78 x 38 mm | Caixa de carregamento: 79 x 40 x 32 mm | Caixa: 128 x 110 x 58 mm

∓ PDP – 50 x 10 mm



### CARACTERÍSTICAS:

- Microfone
- Botão para atender chamadas
- Conexão à playlist do dispositivo móvel
- Caixa de carregamento



103

## Wiretap 97926

Os WIRETAP são fones de ouvido wireless com transmissão por bluetooth 5.0 em metal e ABS de design arrojado e distinto. Ao permitir o isolamento de som e ao serem resistentes à água, os WIRETAP distinguem-se pela sua qualidade e pelas suas funcionalidades que incluem microfone, botão para atender chamadas e conexão à playlist do dispositivo móvel. Os fones têm um alcance de 10 m e frequência de 20-20kHz e potência 5mW (32Ω). A sua autonomia em uso é até 6h e em standby até 100h. O estojo de carregamento tem uma capacidade até 500 mAh, e é compatível com carregador por indução e conector micro USB. Fornecidos em caixa presente.

∓ 45 x 76 x 29 mm | Caixa: 126 x 124 x 49 mm

∓ PDP – 25 x 10 mm



### CARACTERÍSTICAS:

- Microfone
- Botão para atender chamadas
- Conexão à playlist do dispositivo móvel
- Caixa de carregamento
- Resistente à água





103

## Groovy 97928



Os GROOVY são fones de ouvido com microfone, confortáveis e elegantes, em c. sintético, metal e ABS. Os GROOVY são wireless dobráveis, práticos e ideais para o dia-a-dia com uma capacidade de bateria de 300 mAh e autonomia até 15 h. A transmissão é por bluetooth 4.2 com um alcance até 10 metros. A potência são 100 mW (32Ω) e frequência 20Hz-20kHz. Seus botões permitem controlar o volume, atender chamadas e interagir com a playlist do dispositivo móvel. Incluso cabo para carregar. Fornecidos em caixa presente.

📏 200/225 x 215 x 73 mm | Caixa: 265 x 250 x 65 mm

📦 PDP - 30 x 30 mm



### CARACTERÍSTICAS:

- Dobráveis
- Microfone
- Controle de volume
- Botão para atender chamadas
- Conexão à playlist do dispositivo móvel
- Inclui cabo

# FONES DE OUVIDO



103

## Hearkeen 97919



Os HEARKEEN são fones de ouvido versáteis em ABS e silicone, perfeitos para diversos momentos do dia-a-dia. Devido ao seu design versátil, podem ser usados em ambientes mais profissionais, ou na prática esportiva. A transmissão por bluetooth 5.0, elevam a praticidade destes fones, com um alcance sem fios até 10 m. Têm uma frequência de 20Hz-20kHz e potência de 5mW(16Ω). Suas funcionalidades incluem botão para atender chamadas, controle de volume e conexão à playlist do dispositivo móvel. A capacidade da bateria é de 90mAh e a autonomia em uso é até 8h e em standby é até 6 dias. Incluso cabo. Fornecido em caixa presente.

↳ Auriculares (cada): 33 x 16 x 24 mm | Comprimento da faixa do pescoço: 455 mm | Caixa: 201 x 220 x 40 mm  
 ↗ PDP – 20 x 5 mm



### CARACTERÍSTICAS:

- Microfone
- Botão para atender chamadas
- Controle de volume
- Conexão à playlist do dispositivo móvel



107

## Vibration 97923



Os VIBRATION são fones de ouvido, com fios, em metal e ABS de design moderno que se destacam pelo seu acabamento metalizado nos vários detalhes do produto. Tem uma frequência de 20Hz-20kHz (16Ω), microfone e botão para atender chamadas. Incluso cabo de 1,3 m (Jack 3,5 mm). Fornecidos em caixa presente.

↳ 20 x 18 x 20 mm | Caixa: 88 x 97 x 45 mm  
 ↗ LSR – 14 x 3 mm



### CARACTERÍSTICAS:

- Microfone
- Botão para atender chamadas
- Conexão à playlist do dispositivo móvel

# CAIXA DE SOM



103

## Blare 97257



A BLARE é uma caixa de som com microfone de design moderno e discreto em ABS. A caixa é um objeto que se torna um parceiro para todos os momentos devido às suas características técnicas e funcionais como botão para atender chamadas e conexão à playlist do dispositivo móvel. A BLARE tem transmissão por bluetooth 5.0, alcance até 10 m e frequência de 90Hz-20kHz. A sua capacidade é de 500 mAh, 3W/4Ω e tem autonomia até 6 h. Incluso cabo para carregar e entrada AUX para Jack 3,5mm. Fornecida em caixa presente.

┆ 60 x 63 x 70 mm | Caixa: 120 x 139 x 83 mm

┆ PDP – 20 x 30 mm



### CARACTERÍSTICAS:

- Microfone
- Botão para atender chamadas
- Conexão à playlist do dispositivo móvel
- Inclui cabo



133

## Thunder 97258



A THUNDER é uma caixa de som com microfone em tecido texturado e ABS de design elegante e acabamentos detalhados. Com transmissão bluetooth 5.0 e alcance até 10 m, é um objeto que se enquadra na perfeição num ambiente elegante e sofisticado. A THUNDER tem uma capacidade de 1 200 mAh, potência de 2x3W (3Ω) e autonomia até 5h. A frequência é de 150-180kHz. Contém entrada AUX para Jack 3,5mm. Fornecida em caixa presente.

┆ 73 x 196 x 54 mm | Caixa: 275 x 123 x 74 mm

┆ SCR – 40 x 15 mm



### CARACTERÍSTICAS:

- Microfone
- Botão para atender chamadas
- Controle de volume
- Conexão à playlist do dispositivo móvel



# + CARREGADORES WIRELESS BATERIAS PORTÁTEIS



103

## LED Magnet 97920



O MAGNET é um carregador wireless robusto, de design moderno em zinco e acrílico. Este carregador é compatível com smartphones que têm tecnologia de carregamentos sem fios, ideal para usar comodamente em casa ou no escritório. Incluso indicador de carga LED e tem uma potência de carregamento máxima de 10W. Com cabo USB-C de 1 metro incluso. Fornecido em caixa presente.

108 x 96 x 15 mm | Caixa: 157 x 179 x 34 mm  
LSR – 20 x 5 mm



### CARACTERÍSTICAS:

- Compatível com smartphones que têm tecnologia de carregamentos sem fios

133

## LED Horde 97921



O HORDE é um carregador wireless que funde liga de zinco e tecido num cruzamento perfeito que culmina num objeto de design elegante e sofisticado. O HORDE é compatível com smartphones que têm tecnologia de carregamentos sem fios, tornando-se um aliado para o dia-a-dia. Contém indicador de carga LED e tem uma potência de carregamento máxima de 15W. Com cabo USB-C de 1 metro incluso. Fornecido em caixa presente.

101 x 87 x 16 mm | Caixa: 169 x 154 x 34 mm  
LSR – 30 x 3 mm



### CARACTERÍSTICAS:

- Compatível com smartphones que têm tecnologia de carregamentos sem fios

107

LED **Think 97916**

A THINK é uma versátil bateria portátil com uma base de carregamento em ABS e PC que permite simultaneamente ser usada como um carregador wireless. A THINK é um objeto de design arrojado e dadas as suas características técnicas tanto pode ser usado em viagens (como bateria portátil) ou como carregador wireless. Bateria em polímero de lítio com indicador de carga LED. Possibilita o carregamento de até 2 dispositivos em simultâneo, com entrada USB tipo C e saídas USB tipo C e USB tipo A. Capacidade de 10 000 mAh e potência de carregamento wireless de 10W. Fornecida em caixa presente, com cabo de 1 m incluído.

⊥ 145 x 90 x 97 mm | Caixa: 212 x 195 x 58 mm  
 ↗ PDP – 50 x 30 mm



**CARACTERÍSTICAS:**

- Carrega 2 dispositivos em simultâneo
- Indicador de carga LED
- Compatibilidade universal
- Bateria polímero de lítio



133

LED **Trencher 97925**

A TRENCHER é uma bateria portátil forrada a tecido numa estrutura em ABS com acabamento em borracha que se distingue pelo seu design moderno, elegante e simultaneamente, intimista. Bateria em polímero de lítio com indicador de carga LED. Possibilita o carregamento de até 2 dispositivos em simultâneo com entrada DC 5V/2.1A e saída DC 5V/1-2.1A. Prática e moderna bateria portátil com capacidade de 10 000 mAh e potência de carregamento de 5V. Fornecida em caixa presente, com cabo USB tipo C incluso.

⊥ 140 x 70 x 16mm | Caixa: 212 x 112 x 29 mm  
 ↗ SCR – 45 x 15 mm



**CARACTERÍSTICAS:**

- Carrega 2 dispositivos em simultâneo
- Indicador de carga LED
- Compatibilidade universal
- Bateria polímero de lítio



103

LED **Crowd 97917**

A Crowd é uma bateria portátil em ABS de design elegante e inovador pensada de forma a ser um objeto intuitivo e facilitador no dia-a-dia. Bateria em polímero de lítio com indicador de carga LED. Possibilita o carregamento de até 2 dispositivos em simultâneo com entrada DC 5V/2.0A e saída DC 5V/1-2.1A. Bateria prática para levar para qualquer lugar com capacidade de 5 000 mAh e potência de carregamento de 5V. Fornecida em caixa presente, com cabo micro USB incluso.

⊥ 98 x 64 x 14 mm | Caixa: 148 x 144 x 34 mm  
 ↗ DUV – 35 x 45 mm



**CARACTERÍSTICAS:**

- Carrega 2 dispositivos em simultâneo
- Indicador de carga LED
- Compatibilidade universal
- Bateria polímero de lítio







## Coleção Bambu

O melhor da tecnologia aliada ao bambu: um material natural e amigo do ambiente.



B

A





• Autonomia até **5h**



103

• Função de rádio

A

NEW

ecologic



 **Tilly** — 97095

 Caixa de som portátil em ABS reciclado e bambu. Com potência de 3W e transmissão por bluetooth 5.0 e função de rádio. Tempo de reprodução até 5h com uma bateria de 1200 mAh. Fornecido em caixa presente de papel craft.

 135 x 40 x 65 mm

 LSR – 60 x 40 mm



• Autonomia até **4h**



103

• Função de rádio

B

NEW

ecologic



 **Mayer** — 97098

 Caixa de som portátil em ABS reciclado e bambu. Com potência de 3W e transmissão por bluetooth 5.0 e função de rádio. Tempo de reprodução até 4h com uma bateria de 500 mAh. Fornecido em caixa presente de papel craft.

 70 x 70 x 37 mm

 LSR – 50 x 12 mm



**ECologic**

**Fitch Eco** — 57909

Bateria portátil com carregador wireless em bambu. Bateria de lítio com capacidade de 5.000mAh e tempo de vida  $\geq$  500 ciclos. Contém entrada/saída de 5V/2A, indicador de carga, 1 porta micro USB, 1 porta USB tipo C e 1 porta USB. Potência de saída wireless, no máximo, de 5W. Incluso cabo USB / micro USB para carregar. Compatível com smartphones com tecnologia de carregamento sem fios. Fornecido em caixa presente de papel craft.

∓ 140 x 70 x 12 mm

↗ LSR - 120 x 50 mm

**ECologic**

**Kohn 5.0** — 57915

Bateria portátil em bambu com bateria de lítio com capacidade de 5.000 mAh e tempo de vida  $\geq$  500 ciclos. Entrada 5V/2A e saída 5V/1-2A com 1 porta micro USB, 1 porta USB tipo C e 1 porta USB. Inclui cabo USB / micro USB para carregar e contém indicador de carga. Fornecido em caixa presente de papel craft.

∓ 120 x 51 x 15 mm

↗ LSR - 80 x 30 mm



**Darwin II** — 57390

Relógio em MDF com calendário, alarme e termômetro. Incluso 4 pilhas AAA, 1 pilha CR2032 e cabo USB. Fornecido em caixa presente.

∓ 150 x 70 x 44 mm | Caixa: 170 x 92 x 54 mm

↗ SCR - 120 x 25 mm



**ECologic**

**Glashow Eco** — 57256

Caixa de som com microfone em bambu. Transmissão por bluetooth 3.0, ligação stereo 3,5 mm e leitor de cartões TF e potência de 3W (4Ω). Bateria com capacidade até 300 mAh e autonomia até 3 horas. Função para atender chamadas, controle de volume, conexão à playlist do dispositivo móvel e rádio FM. Incluso cabo USB / micro USB para carregar e cabo de áudio (Jack/ Jack). Fornecida em caixa presente de papel craft.

∓ Ø60 x 52 mm

↗ PDP - 20 x 25 mm







Suporte para esferográficas



**ECologic**

**Leavitt II** — 57940

Carregador wireless de bobina dupla em bambu com suporte para esferográficas. Potência de carregamento rápida de 10W e com entradas 5V/2A e 9V/1.67A. Incluso cabo de carregamento USB tipo C de 1m. Fornecido em caixa presente de papel craft.

▮ 77 x 71 x 118 mm

▮ LSR – 60 x 80 mm



**Atalla** — 97539 / 97540

▮ .97



**ECologic**

**Ecopower** — 57910

Carregador wireless em bambu. Entradas 5V/2A e potência máxima de carregamento de 5W. Incluso cabo USB/micro USB de 1m para carregar. Compatível com smartphones com tecnologia de carregamento sem fios.

▮ 92 x 92 x 9 mm

▮ LSR – 70 x 70 mm



Hub USB e suporte para celular



**ECologic**

**Motto** — 57911

Organizador de mesa em bambu e ABS. Incluso carregador wireless, hub USB e suporte para celular. Entrada 5V/1.5A. Potência de saída, no máximo, de 5W. 1 porta USB e 1 porta USB tipo C. Incluso cabo USB/tipo C, de 90 cm, para carregar. Compatível com smartphones com tecnologia de carregamento sem fios. Fornecido em caixa presente de papel craft.

▮ 255 x 135 x 14 mm

▮ LSR – 120 x 60 mm





### ECologic



#### Maxwell — 57932

Suporte para celular com carregador wireless em fibra de palha de trigo e ABS. Com uma potência de carregamento rápida de 10W e com entradas 5V/2A e 9V/1.67A. Incluso cabo de carregamento micro USB de 1 m. Fornecido em caixa presente de papel craft.

± 70 x 112 x 87 mm

➤ PDP – 40 x 30 mm



### ECologic



#### Piyon — 57936

Caixa de som portátil em fibra de palha de trigo e ABS com alça em silicone para facilitar o transporte, potência de 3W e transmissão por bluetooth 5.0. Tempo de reprodução de 4h30, com uma bateria de 500 mAh. Incluso cabo micro USB. Fornecido em caixa presente de papel craft.

± 70 x 70 x 34 mm

➤ PDP – 40 x 40 mm



### ECologic



#### Cuvier II — 57929

Carregador wireless em ABS e fibra de palha de trigo. A potência de carregamento é de 5W, com entrada 5V/2A. A base contém um círculo em silicone para o equipamento não se mova enquanto carrega. Incluso cabo micro USB de 1 m. Fornecido em caixa presente de papel craft.

± Ø70 x 10 mm

➤ PDP – Ø30 mm



## Coleção de Palha de Trigo

Produtos tecnológicos numa versão mais sustentável.



**ECÓlogic**



**Galois** — 57930

Caixa de som portátil em fibra de palha de trigo e ABS com microfone. Potência de 3W e transmissão por bluetooth 5.0. Com tempo de reprodução de 2 horas e uma bateria de 300 mAh. Incluso cabo micro USB. Fornecido em caixa presente de papel craft.

∅ 62 x 48 mm

PDP – 15 x 20 mm



**ECÓlogic**



**Lezzo** — 58517



Luminária de mesa em ABS e fibra de palha de trigo com carregador wireless. A haste é flexível para ajustar a direção da luz e contém 20 LEDs que permitem uma iluminação até 3 níveis de intensidade. No topo da luminária encontra-se um botão touch para ligar, desligar e ajustar os níveis de iluminação. O carregador sem fios é de carregamento rápido, tendo uma potência até 10W, com entradas 5V/2A e 9V/1.67A. No local onde o equipamento é colocado tem um círculo com silicone para evitar que se mova. Incluso cabo micro USB de 1 m. Fornecido em caixa presente de papel craft.

160 x 268 x 85 mm

PDP – Ø40 mm

Flexível e direcionável



Com carregador wireless

160



## Tecnologia sustentável

O uso de matérias naturais estendeu-se também ao universo tecnológico, criando peças únicas e mais amigas do ambiente.



A

ECÓlogic

**Marconi** — 57939

Fones de ouvido dobráveis wireless em fibra de palha de trigo e ABS. Potência de 32mW e transmissão bluetooth 5.0 com alcance até 10m. Bateria com capacidade de 400mAh e tempo de reprodução até 13 horas. Incluso porta AUX, slot para cartão TF/SD e cabo de carregamento micro USB. Botões de controle com +/- e ligar/desligar. Fornecido em caixa presente de papel craft.

📏 Auscultadores (fechados): 185 x 185 x 74 mm |  
Caixa: 120 x 90 x 160 mm

📏 PDP – 20 x 40 mm



Com microfone

ECÓlogic

**Fourier Tw** — 57938

Fones de ouvido True Wireless em fibra de palha de trigo e PP, com transmissão por bluetooth 5.0 até 10m de distância e tempo de reprodução até 3 horas (standby até 10h). Cada fone tem um botão multifunções e microfone integrado, facilitando atender chamadas em modo mãos-livres, e indicador luminoso LED. O estojo de carregamento tem uma bateria de 300 mAh e indicador de status de carregamento e bateria. Incluso um cabo de carregamento micro USB. Fornecido em caixa presente de papel craft.

📏 80 x 38 x 32 mm

📏 PDP – 25 x 10 mm



# O aliado certo para o trabalho remoto



Controle de volume

B

Conexão USB A

Autonomia até **12h**



147



113

B

NEW

## Hopper — 57935

 Fones de ouvido em ABS e PU com microfone, transmissão por bluetooth 5.0 e potência de 30 mW. A bateria tem uma capacidade de 300 mAh e tempo de reprodução de 12 horas. Produto com cabo de carregamento micro USB incluso. Fornecido em caixa de oferta.

195 x 165 x 88 mm | 210 mm

PDP - 20 x 10 mm



## Kilby — 97088

Fone de ouvido ajustável com microfone em ABS e PP. Inclui um controle de som com 4 botões: aumentar/diminuir volume, desligar microfone e sem som. Frequência de resposta de 20Hz-20KHz, impedância 32Ω, cabo de 1,85 m e conexão por USB A. Fornecidos em caixa presente.

170 x 185 x 75 mm

X

# Permite emparelhamento com 2 dispositivos móveis em simultâneo



Fone com estrutura almofadada



Fones de ouvido dobráveis



103



105

Botão para atender chamadas



105

114

106

103



## Edwin Bk — 57355

Fone de ouvido ajustáveis em ABS, com acabamento emborrachado e transmissão por bluetooth. Autonomia até 5 h. Função para atender chamadas, controle de volume e conexão à playlist do dispositivo móvel. Permite emparelhamento com 2 dispositivos móveis em simultâneo. Incluso cabo USB / micro USB para carregar. Fornecido em caixa presente.

157 x 165 x 42 mm | Caixa: 161 x 200 x 55 mm

PDP - 30 x 10 mm



## Bannon — 57365

Fone de ouvido dobrável e ajustável em ABS com estrutura almofadada, transmissão por bluetooth e leitor de cartões TF. Autonomia até 4 h. Função para atender chamadas, controle de volume, conexão à playlist do dispositivo móvel e rádio FM. Incluso cabo micro USB para carregar. Fornecido em caixa presente.

Dobrados: 165 x 135 x 70 mm | Caixa: 150 x 150 x 70 mm

PDP - 30 x 15 mm



**Spirited** — 97205  
 .364



106  
 Fone magnético

Banda de pescoço

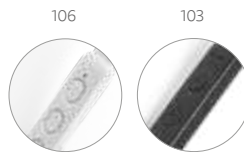

**Medley** — 57914

Fone de ouvido em PC. Transmissão por bluetooth com banda para pescoço com autonomia até 7 horas. Função para atender chamadas, controle de volume e conexão à playlist do dispositivo móvel. Incluso cabo USB / micro USB para carregar. Fornecido em bolsa em non-woven.

190 x 200 mm  
 PDP – 6 x 30 mm



114



103

A

**Wilkins** — 97341

Fone de ouvido desportivo em ABS e silicone com transmissão por bluetooth. Autonomia até 3 h. Função para atender chamadas e conexão à playlist do dispositivo móvel. Incluso cabo micro USB para carregar. Fornecido com bolsa em non-woven.

150 x 135 x 50 mm  
 PDP – 40 x 10 mm



103

Fone magnético



106

103

**Ottoflex** — 57913

Fone de ouvido em PC. Transmissão por bluetooth 4.1 com autonomia até 3 horas. Função para atender chamadas, controle de volume e conexão à playlist do dispositivo móvel. Incluso cabo USB / micro USB para carregar. Fornecido em bolsa em EVA.

80 x 65 x 32 mm  
 DUV – 40 x 30 mm



Com microfone  
incorporado



119

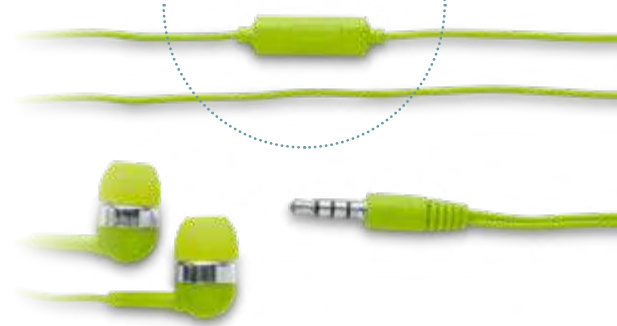

119

114

105

106

103

**NEW**

**Osler** — 97092

Fone de ouvido com microfone incorporado e cabo de 1,20 m com ligação stereo 3,5 mm. Inclui 2 pares extra de adaptadores de fone em silicone (dois tamanhos diferentes). Fornecidos em caixa de PS e ABS.

Caixa: 70 x 70 x 18 mm

SCR - 50 x 50 mm



114



105



106



103

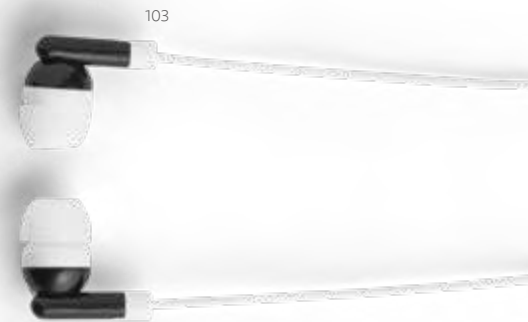

103



**Farday** — 57360

Fone de ouvido com cabo de 1,25 m com ligação stereo 3,5 mm. Fornecido em caixa de PS/ABS.

Caixa: 60 x 64 x 16 mm

SCR - 25 x 25 mm

# Práticos e fáceis de levar para qualquer lado



NEW

## **Kandel** — 97912

Fone de ouvido wireless stereo em ABS. Transmissão por bluetooth com autonomia até 6 horas. Função para atender chamadas, controle de volume e conexão à playlist do dispositivo móvel. Inclui cabo USB / micro USB para carregar. Fornecidos em caixa com função de carregador.

📏 71 x 55 x 28 mm | Auricular: 47 x 21 x 21 mm

🔪 PDP – 25 x 20 mm



106



103



A

NEW

## **Klebs** — 97085

Fone de ouvido True Wireless em ABS com microfone e caixa de carregamento de 250mah. Transmissão por bluetooth 5.1, autonomia até 1.5h, frequência 20Hz-20KHz, 98 dB e impedância de 32Ω. Cada fone tem um botão multifunções e a caixa tem uma porta micro USB para ser carregada. Fornecidos em caixa.

📏 Auricular: 47 x 19 x 8 mm | Caixa: 55 x 64 x 26 mm

🔪 PDP – 20 x 20 mm



Presilha em silicone para transporte



103



114



103

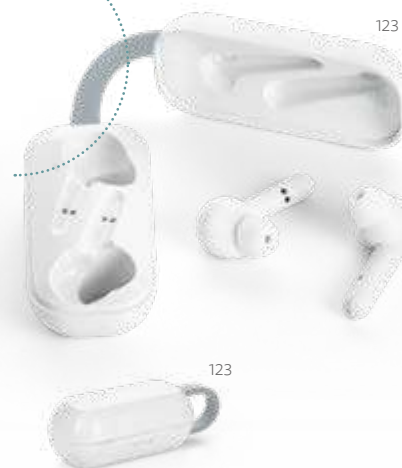

123

123

## **Rubin** — 57934

Fones de ouvido wireless stereo em ABS com transmissão por bluetooth 5.0 e tempo de reprodução até 3 horas. O estojo de carregamento, com uma bateria 250 mAh, é também em ABS e contém uma presilha em silicone que permite transportar e carregar os fones de forma fácil e cômoda. Produto com cabo de carregamento micro USB incluso. Fornecido em caixa de oferta.

📏 77 x 36 x 30 mm

🔪 PDP – 50 x 12 mm

## **Rubin Wh** — 57937

Fones de ouvido wireless stereo em ABS com transmissão por bluetooth 5.0 e tempo de reprodução de 3 horas. O estojo de carregamento, com uma bateria 250 mAh, é também em ABS e contém uma presilha em silicone que permite transportar e carregar os fones de forma fácil e confortável. Produto com cabo de carregamento micro USB incluso. Fornecido em caixa presente.

📏 77 x 36 x 30 mm

🔪 PDP – 40 x 10 mm

As caixas de som também vêm acompanhando as novas tendências, utilizando tecidos de qualidade e de variadas cores para dar o toque que faltava no seu novo espaço de trabalho



Alça para transporte



A

**Gent** — 57395

Caixa de som com microfone em ABS, tecido em poliéster e acabamento emborrachado. Transmissão por bluetooth, ligação stereo 3,5 mm e leitor de cartões TF. Potência de 3W/4Ω. Função para atender chamadas, controle de volume, conexão à playlist do dispositivo móvel e rádio FM. Incluso cabo USB para carregar. Fornecida em caixa presente.

120 x 80 x 40 mm | Caixa: 142 x 85 x 45 mm

TRS – 60 x 20 mm

**Ecclus** — 57385

Caixa de som com microfone em ABS e tecido em poliéster. Com gancho e acabamento emborrachado. Transmissão por bluetooth, potência de 3W/4Ω e autonomia até 3 h. Função para atender chamadas, controle de volume e conexão à playlist do dispositivo móvel. Incluso cabo para carregamento. Fornecida em caixa presente.

Ø90 x 40 mm | Caixa: 115 x 95 x 45 mm

PDP – 20 x 7 mm





B



B

**Grubbs Bk** — 57933

Caixa de som portátil em ABS com acabamento em borracha e tecido na parte frontal. De design sofisticado, esta caixa de som tem um tempo de reprodução de 2 horas, com transmissão por bluetooth 5.0 e potência de 3W. Adicionalmente tem também a funcionalidade de carregador wireless, com uma potência de 5 W, com entrada 5V/2A e bateria de 300 mAh. Incluso cabo de carregamento micro USB. Fornecida em caixa presente.

108 x 56 x 54 mm  
PDP – 35 x 15 mm



**Chion** — 97396

Caixa de som com microfone em ABS, tecido em poliéster e acabamento emborrachado. Transmissão por bluetooth, ligação stereo 3,5 mm e leitor de cartões TF. Potência de 3W/4Ω. Função para atender chamadas, controle de volume, conexão à playlist do dispositivo móvel e rádio FM. Incluso cabo USB para carregar. Fornecida em caixa presente.

140 x 80 x 45 mm | Caixa: 160 x 82 x 60 mm  
PDP – 50 x 8 mm



**Harris** — 97397

Caixa de som com microfone em ABS, tecido em poliéster e acabamento emborrachado. Transmissão por bluetooth, ligação stereo 3,5 mm e leitor de cartões TF. Com 2 x 3W/4Ω. e autonomia até 3 h. Função para atender chamadas, controle de volume, conexão à playlist do dispositivo móvel e rádio FM. Incluso cabo USB para carregar. Fornecida em caixa presente.

155 x 230 x 55 mm | Caixa: 170 x 260 x 70 mm  
TRS – 60 x 110 mm



- Holly** — 57335
- Caixa de som com microfone. em ABS, com transmissão por bluetooth, ligação stereo 3,5 mm e leitor de cartões TF, com 3W/4Ω e autonomia até 3 h. Função para atender chamadas, controle de volume e conexão à playlist do dispositivo móvel. Com apoio antideslizante para celular. Incluso cabo USB para carregar. Fornecida em caixa presente.
  - ∅85 x 66 mm | Caixa: 93 x 93 x 85 mm
  - PDP – 20 x 10 mm



- Euclidean** — 57340
- Caixa de som com microfone em ABS e acabamento emborrachado. Transmissão por bluetooth, potência de 3W/4Ω e autonomia até 3 h. Função para atender chamadas, controle de volume e conexão à playlist do dispositivo móvel. Incluso cabo USB para carregar. Fornecida em caixa presente.
  - 150 x 56 x 58 mm | Caixa: 155 x 60 x 60 mm
  - PDP – 30 x 5 mm



- Perry** — 57253
- Caixa de som com microfone em ABS e acabamento emborrachado. Transmissão por bluetooth e leitor de cartões TF. Com 3W/4Ω e autonomia até 2h. Função para atender chamadas, controle de volume e conexão à playlist do dispositivo móvel. Incluso cabo USB / micro USB para carregar.
  - ∅59 x 55 mm
  - PDP – 25 x 8 mm



- Bow** — 97328
- Caixa de som à prova de água em ABS e acabamento emborrachado com ventosa. Transmissão por bluetooth e potência de 3W/4Ω. Autonomia até 3 h. Função para atender chamadas, controle de volume e conexão à playlist do dispositivo móvel. Incluso cabo para carregamento. Fornecida em caixa presente.
  - ∅85 x 50 mm | Caixa: 88 x 88 x 55 mm
  - PDP – 25 x 7 mm



Personalizável com  
logótipo iluminado

103



 **Edison Bk** — 57255

 Caixa de som portátil, com luz LED no interior, em ABS e acabamento emborrachado. (personalizável com logótipo iluminado). Transmissão por bluetooth 4.2 e potência de 3W (4Ω). Bateria com 300 mAh e autonomia superior a 2h. Incluso cabo 2 em 1: USB / micro USB para carregamento e micro USB/3.5 jack. Fornecida em caixa.

 59 x 59 x 51 mm

 LSR – 30 x 15 mm



 **Symfony** — 57927

 Caixa de som com transmissão por bluetooth e microfone. Com potência de 3W e transmissão por bluetooth 4.0 com alcance de 10m. A capacidade da bateria é de 500 mAh e o tempo de carregamento de 2-3 horas. Tem autonomia até 8 horas, microfone incorporado para chamadas e conferências. Tem botão start/stop e capacidade para rádio FM. Compatível com todos os dispositivos e permite transmissão por bluetooth. Inclui cabo USB/DC 5 V/jack. Fornecida em caixa presente.

 Ø60 x 50 mm | Caixa 97 x 87 x 95 mm

 LSR – 20 x 20 mm



 **Florey II** — 57252

 Caixa de som com microfone em alumínio, com transmissão por bluetooth e leitor de cartões TF com 3W/4Ω. Autonomia até 5h. Função para atender chamadas, controle de volume, conexão à playlist do dispositivo móvel e rádio FM. Incluso cabo micro USB para carregar. Fornecida em caixa presente.

 Ø71 x 42 mm | Caixa: 80 x 80 x 60 mm

 LSR – 20 x 15 mm



## Caixa esterilizadora que permite a eliminação de bactérias



## Carregador wireless de carregamento rápido



### LED Germout — 58519

Caixa esterilizadora em ABS e PC com combinação entre radiação UVC e UVA que permite a eliminação de um número significativo de bactérias. A caixa possui 2 leds UV no interior com uma potência total de 2W, e foi especialmente desenhada para a eliminação de bactérias em objetos de uso diário, como: chaves, celulares, smartphones, máscaras, óculos, comandos, jóias, e outros pequenos utensílios. Eficiência de 70% com apenas 1 ciclo de 5 minutos, e 99,9% com dois ciclos de 5 minutos. Possui um sensor de segurança que desliga de imediato as lâmpadas assim que é aberta a caixa. A parte superior da caixa incluso um carregador wireless de carregamento rápido (10W), com entrada de 5V/3A e porta de carregamento USB tipo C. Incluso cabo de 1 metro. Fornecida em caixa presente.

📏 210 x 120 x 55 mm | Interior: 190 x 95 x 20 mm |

Caixa: 240 x 130 x 71 mm

🔪 SCR – 150 x 70 mm



### Lagrange — 97087

Óculos de realidade virtual em ABS para celulares de 4,7" a 6,5" Com elásticos laterais e superior e lentes ajustáveis. Compatíveis com Android e iOS e com qualquer aplicação disponível em Play Store e AppStore para realidade virtual.

📏 200 x 130 x 110 mm

🔪 PDP – 55 x 15 mm



# Iluminação interativa e sofisticada para o local de trabalho



Flexível e direcionável

• Botão tátil com **3** modos de luz

Adaptável a qualquer estrutura



## **Nesbit II** — 54743

Luminária de mesa portátil em ABS e com LED COB. A luminária tem mola, braço flexível e botão tátil com 3 modos de luz (fraco, médio e forte). Autonomia até 20 horas. Incluso cabo USB de 1 metro para carregamento.

115 x 55 x 380 mm

PDP – 50 x 20 mm



**Conexão com smartphone e coluna de transmissão bluetooth.**

• **18** LED's de alto brilho



## **Graham** — 54734

Luminária de mesa com caixa de som em ABS. Com 18 LEDs de alto brilho, botão tátil e braço flexível. Transmissão por bluetooth e ligação stereo 3,5 mm com 5W/4Ω. Autonomia até 6 h e conexão à playlist do dispositivo móvel. Incluso cabo USB para carregar. Fornecida em caixa presente.

100 x 225 x 100 mm | Caixa: 110 x 235 x 105 mm

PDP – 50 x 12 mm



## Emerge Collection

Pastas multifunções que vão tornar sua vida mais prática e sustentável.



Papel proveniente de uma gestão florestal sustentável



• Com carregador wireless



103



### Emerge A5 Folder — 93581

Pasta A5 em 300D rPET com carregador wireless embutido. A bateria tem capacidade para 5.000 mAh, potência de 10W, entrada/saída 5V/2.1A e cabo USB tipo C para carregar a bateria. A pasta contém no seu interior um bolso para smartphone até 6.5", três espaços para cartões, quatro luzes LED, botão on/off, suportes para esferográfica (não incluída), celular e cabo USB, um bloco de notas com capa em cartão preto e 64 folhas pautadas de cor marfim, em papel proveniente de gestão florestal sustentável. Na frente existe ainda uma impressão oval em preto para indicar a área de carga do wireless. Fornecido em caixa presente.

165 x 225 x 25 mm

PDP - 40 x 15 mm





## Tecnologia sustentável

A melhor tecnologia, aliada ao material mais sustentável do momento.



113



NEW

EcoLogic



**Renewal Battery** — 97094

Bateria portátil 100% rPET, com bateria de lítio, capacidade de 5.000 mAh e entrada/saída de 5V/2A. Inclui uma porta para microUSB, uma porta USB-C e duas portas USB. Fornecida em caixa presente de papel craft.

⊥ 65 x 98 x 10 mm

↗ TRS – 80 x 40 mm



113



NEW

EcoLogic



**Renewal Charger** — 97093

Carregador wireless 100% rPET. A potência de carregamento é de 10W, com entradas 5V/1.6A e 9V/1.5A. Inclui cabo de 1 m. Fornecido em caixa presente de papel craft.

⊥ 100 x 62 x 10 mm

↗ TRS – 80 x 40 mm

# Carregamento Wireless

Leve para todo o lado sem precisar de cabos.



103



103

106

113

## Aldrin X — 57904

 Bateria portátil em ABS com acabamento emborrachado que permite o carregamento do dispositivo por indução. Bateria de lítio com capacidade de 10.000 mAh e tempo de vida  $\geq$  500 ciclos. Com entrada/saída 5V/2.1A e potência de carregamento de 5W. Indicador de carga e portas USB, micro USB e USB tipo C. Incluso cabo USB / micro USB para carregar a bateria. Compatível com smartphones com tecnologia de carregamento sem fios. Fornecida em caixa presente.

135 x 75 x 20 mm | Caixa: 150 x 95 x 25 mm

 DUV - 45 x 30 mm



103



106



Inclui ventosas para facilitar o uso durante a viagem



## Azofi — 97079

 Bateria portátil e carregador wireless em alumínio com LED indicador de carga. Bateria polímero de lítio com capacidade de 4.000 mAh. Entrada 5V/2A e saída 5V/2A e potência de carregamento: 5W. Incluso cabo USB / micro USB para carregar a bateria. Fornecido em caixa presente.

126 x 71 x 14 mm

 PDP - Ø25 mm



**Cassini 4.0** — 57078

Bateria portátil e carregador wireless em alumínio com bateria de polímero de lítio. Contém uma capacidade de 4.000 mAh e tempo de vida de  $\geq 500$  ciclos. Entrada 5V/2A e saída 5V/2A, com LED indicador de carga. Incluso cabo USB / micro USB para carregar a bateria. Fornecida em caixa presente.

123 x 70 x 10 mm

LSR - 35 x 25 mm



**Coulomb 4.0** — 57344

Bateria portátil slim em alumínio. Bateria de lítio com capacidade de 4.000 mAh, tempo de vida  $\geq 500$  ciclos e com entrada/saída 5V/1A. Incluso cabo USB / micro USB para carregar a bateria. Fornecida em caixa presente.

110 x 68 x 10 mm

LSR - 90 x 50 mm





# Energia sem limites!

Deixe de se preocupar com a bateria dos seus dispositivos! A alta capacidade destas baterias permite vários carregamentos e compatibilidade com vários dispositivos. Para além disso, podem ir com você para qualquer lugar sem ocupar muito espaço.



Capacidade de **16.000** mAh

Indicador de carga e LED

**Raman Bk** — 57905

Bateria portátil em ABS, com LED. Contém bateria de lítio com capacidade de 16.000 mAh e tempo de vida superior a 1.000 ciclos. Tem entrada 5V/2.1A, saída 5V/1-2.1A, indicador de carga, 2 portas USB e 1 porta micro USB. A bateria tem proteção para sobrecarga, curto circuito e sobreaquecimento. Incluso cabo USB/micro USB para carregamento. Fornecida em caixa presente.

156 x 80 x 23 mm | Caixa: 175 x 100 x 30 mm

SCR – 55 x 100 mm



**Zack 7.2** — 57351

Bateria portátil em alumínio. Bateria de lítio com capacidade de 7.600 mAh e tempo de vida  $\geq 500$  ciclos. Com entrada 5V/1A, saída 5V/1-2.1A e 2 portas USB. Incluso cabo USB/micro USB para carregar a bateria. Fornecida em caixa presente.

150 x 74 x 12 mm | Caixa: 165 x 80 x 20 mm

LSR – 120 x 50 mm



**Lumina X** — 97945

Bateria portátil em ABS com LED. Bateria de lítio com capacidade de 10.000 mAh e tempo de vida  $\geq 500$  ciclos. Com entrada 5V/1A, saída 5V/1-2.1A e 2 portas USB. Incluso cabo USB/micro USB para carregar a bateria.

150 x 70 x 11 mm

SCR – 130 x 50 mm



**Emlyn** — 97384

Bateria portátil em alumínio. Bateria de lítio com capacidade de 8.000 mAh, tempo de vida  $\geq 500$  ciclos e com entrada/saída 5V/1A. Incluso cabo USB/micro USB para carregar a bateria. Fornecida em caixa presente.

90 x 77 x 22 mm | Caixa: 110 x 85 x 25 mm

LSR – 70 x 50 mm

# Energia limpa

Recarregue a sua bateria sem ligar na tomada. Aproveite o sol e desfrute das boas energias.



103



**Day** — 97371



Bateria portátil solar em ABS com painel solar e LED. Bateria de lítio com capacidade de 2.000 mAh, entrada/saída 5V/1A e 2 portas USB. Incluso cabo USB / micro USB para carregar a bateria. Fornecida em caixa presente.

143 x 77 x 16 mm | Caixa: 165 x 80 x 20 mm

SCR - 50 x 20 mm



103



103

127



**Ceres** — 97314



Bateria portátil em alumínio com painel solar e LED. Bateria de lítio com capacidade de 8.000 mAh e tempo de vida  $\geq$  500 ciclos. Com entrada 5V/1A, saída 5V/1-2.1A e 2 portas USB. Incluso cabo USB / micro USB para carregar a bateria. Fornecida em caixa presente.

155 x 75 x 10 mm | Caixa: 175 x 100 x 30 mm

LSR - 100 x 50 mm





**Omar 2.0** — 57391

Bateria portátil em ABS. Bateria de lítio com capacidade de 2.000 mAh, tempo de vida  $\geq 500$  ciclos e com entrada/saída 5V/1A. Incluso cabo USB/ micro USB para carregar a bateria. Fornecida em caixa presente.

112 x 42 x 25 mm | Caixa: 173 x 96 x 30 mm

SCR – 60 x 15 mm



**Lambda 4.0** — 97943

Bateria portátil em alumínio. Bateria de lítio com capacidade de 4.000 mAh, tempo de vida  $\geq 500$  ciclos e com entrada/saída 5V/1A. Incluso cabo USB/ micro USB para carregar a bateria. Fornecida em caixa presente.

91 x 56 x 24 mm

LSR – 80 x 32 mm

Inclui cabo USB/ micro USB



**Hubble** — 97076

Bateria portátil em ABS. Bateria polímero de lítio com capacidade de 4.000 mAh, tempo de vida  $\geq 500$  ciclos, entrada 5V/1A e saída 5V/1A. 1 porta USB. Incluso cabo USB/ micro USB para carregar a bateria. Fornecida em caixa presente.

102 x 52 x 22 mm

PDP – 55 x 25 mm



**Barium 4.0** — 97942

Bateria portátil em ABS. Bateria de lítio com capacidade de 4.000 mAh, tempo de vida  $\geq 500$  ciclos e com entrada/saída 5V/1A. Incluso cabo USB/ micro USB para carregar a bateria.

100 x 55 x 25 mm

SCR – 90 x 45 mm





Inclui ventosas •



**Gagarin** — 97394

Bateria portátil em ABS com ventosas na base. Bateria de lítio com capacidade de 4.000 mAh, tempo de vida  $\geq$  500 ciclos e com entrada/saída 5V/1A.

Incluso cabo USB / micro USB para carregar a bateria.

⊞ Bateria: 123 x 50 x 14 mm | Base: 65 x 58 x 10 mm

➤ DUV – 80 x 40 mm



**Sagan** — 97077

Bateria portátil em ABS e aço inox com tela touch e indicador de carga. Bateria polímero de lítio com capacidade de 4.000 mAh e tempo de vida  $\geq$  500 ciclos. Entrada 5V/1A e saída 5V/1A. Incluso cabo USB / micro USB para carregar a bateria. Fornecido em caixa presente.

⊞ 116 x 65 x 7 mm

➤ PDP – 55 x 25 mm



**Leo 2.2** — 57323

Bateria portátil em alumínio. Bateria de lítio com capacidade de 2.200 mAh, tempo de vida  $\geq$  500 ciclos e com entrada/saída 5V/1A. Incluso cabo USB/ micro USB para carregar a bateria.

▮ 95 x 23 x 22 mm

▮ LSR – 80 x 13 mm



**Leo 1.8** — 97376

Bateria portátil em alumínio. Bateria de lítio com capacidade de 1.800 mAh, tempo de vida  $\geq$  500 ciclos e com entrada/saída 5V/1A. Incluso cabo USB/ micro USB para carregar a bateria.

▮ 95 x 23 x 22 mm

▮ LSR – 85 x 13 mm



**Boole 1.5** — 97946

Bateria portátil em ABS. Bateria de lítio com capacidade de 1.500 mAh, tempo de vida  $\geq$  500 ciclos e com entrada/saída 5V/1A. Incluso cabo USB/ micro USB para carregar a bateria. Fornecida em caixa presente.

▮ 100 x 28 x 23 mm

▮ PDP – 50 x 15 mm



**Bit** — 97162 / 97941 / 97944

Bateria portátil em ABS. Tempo de vida  $\geq$  500 ciclos e com entrada/saída 5V/1A. Incluso cabo USB/ micro USB para carregar a bateria.

97162: capacidade 1.000 mAh

97941: capacidade 1.600mAh

97944: capacidade 2.000 mAh

▮ 96 x 22 x 24 mm

▮ TP – 97 x 944 mm



# Transforme seu pen drive em um presente exclusivo com a caixa de presente



## Simon 8Gb — 97434

Pen Drive UDP mini com 8GB em alumínio. Fornecida em caixa em PP.

☒ 33 x 12 x 6 mm | Caixa: 68 x 25 x 15 mm

🔪 PDP – 25 x 8 mm

## ecologic

### Atalla — 97539 / 97540

Pen drive em bambu. 97539: capacidade 8GB 97540: capacidade 16GB

☒ 59 x 19 x 12 mm

🔪 TP – 97 x 540 mm



## Signy — 97348

Caixa para pen drive em cartão.

☒ 115 x 60 x 26 mm

🔪 SCR – 90 x 45 mm



## Penrose — 97517 / 97528 / 97529

Pen drive com memória COB em alumínio.

97517: capacidade 8GB

97528: capacidade 16GB

97529: capacidade 32GB

☒ 12 x 37 x 5 mm

🔪 TP – 97 x 529 mm



## Weinberg — 97527 / 97543

Pen drive em c. sintético.

97527: capacidade 8GB

97543: capacidade 16GB

☒ 80 x 21 x 16 mm

🔪 TP – 97 x 543 mm



## Mosfet — 97525 / 97541

Pen drive em c. sintético.

97525: capacidade 8GB

97541: capacidade 16GB

☒ 58 x 27 x 12 mm

🔪 TP – 97 x 541 mm



# Conjuge com os carregadores rápidos

57906 / 57907 / 57908



## Steven — 57154

Estação de carregamento USB em ABS com 5 saídas 5V/4A. Incluso cabo com 1,5 m.

∓ 65 x 110 x 80 mm

➤ PDP – 20 x 50 mm



## Redy — 57362

Adaptador USB. ABS. Com 2 saídas 5V/1-2.1A.

∓ 62 x 42 x 23 mm

➤ DUV – 30 x 30 mm



## Caine — 57326

Kit de adaptadores USB em ABS. Incluso adaptador de corrente DC 110V/220V e adaptador para carro DV 12-24V. Fornecido com bolsa EVA.

∓ Bolsa: 112 x 80 x 45 mm

➤ TRS – 70 x 45 mm



## Newton II — 57312

Kit de adaptadores USB em ABS. Incluso adaptador de corrente DC 110V/220V e adaptador para carro DV 12-24V. Fornecido com bolsa EVA.

∓ Bolsa: Ø75 x 36 mm

➤ SCR – Ø40 mm

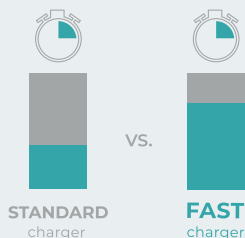

# SUPER FAST

## Conjuge com o adaptador

57362

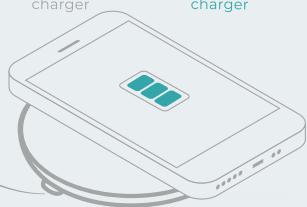

### **Burnell Bk** — 57908

Carregador wireless rápido em ABS com acabamento emborrachado. Entradas 5V/2A e 9V/1,67A. Potência máxima de carregamento de 10W. Incluso cabo USB / micro USB de 1 m para carregar. Compatível com smartphones com tecnologia de carregamento sem fios. Fornecido em caixa.

⊘ Ø99 x 9 mm | Cabo: 1000 mm

➤ LSR - Ø50 mm

### **Jolly** — 57907

Carregador wireless rápido em ABS e alumínio. Com entradas 5V/2A e 9V/1,67A e potência de carregamento 5W, 7.5W e 10W. Incluso cabo USB / micro USB para carregar. Compatível com smartphones com tecnologia de carregamento sem fios. Fornecido em caixa presente.

⊘ Carregador: Ø100 x 9 mm | Cabo: 1000 mm

➤ PDP - 50 x 30 mm

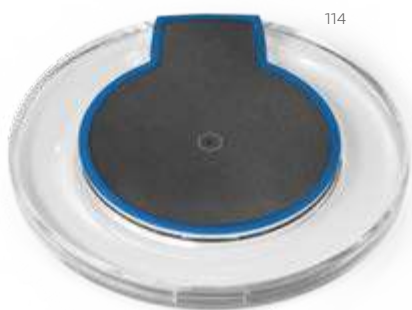

### **Carson** — 57346

Carregador wireless em ABS e que permite carregamento do dispositivo por indução. Tem entrada 5V/2A e potência de carregamento de 5W. Incluso cabo USB / micro USB para carregar. Compatível com smartphones com tecnologia de carregamento sem fios.

⊘ Ø100 x 10 mm

➤ PDP - 40 x 25 mm



### **Hyper** — 57906

Carregador wireless rápido em ABS e silicone. Tem entrada 5V/2A e 9V/1.67A. Potência máxima de carregamento de 5W, 7.5W e 10W. Incluso cabo USB / micro USB para carregar. Compatível com smartphones com tecnologia de carregamento sem fios. Fornecido em caixa presente.

⊘ Ø69 x 10 mm

➤ PDP - Ø40 mm



106



103



**Alencar** — 97399

Mouse wireless dobrável 2.4G. em ABS com acabamento emborrachado. Incluso 2 pilhas AAA. Fornecido em caixa transparente.

∓ 60 x 112 x 20 mm | Caixa: 75 x 130 x 44 mm

➤ **DUV** – 40 x 90 mm



105



105

114



106

103



**Blackwell 2.4** — 57304

Mouse wireless 2.4G. em ABS. Incluso 2 pilhas AAA. Fornecido em caixa transparente.

∓ 57 x 113 x 20 mm | Caixa: 64 x 120 x 36 mm

➤ **PDP** – 30 x 20 mm



119



114



113

**Crick 2.4** — 57398

Mouse wireless 2.4G. em ABS com Acabamento emborrachado. Incluso 2 pilhas AAA.

∓ 65 x 105 x 20 mm

➤ **PDP** – 40 x 8 mm



104



104

106

103



119



119

114

105

106

103



106



106

**Jannes** — 97318

Hub USB 2.0. com 4 portas para conectar até 4 dispositivos móveis.

∓ 52 x 41 x 12 mm

➤ **DUV** – 40 x 20 mm

**Gardner** — 97357

Hub USB 2.0 em ABS com 4 portas.

∓ Ø52 x 18 mm

➤ **PDP** – Ø35 mm

**Emmy** — 97153

Cabo USB 3 em 1 em ABS e PVC. Adequado para carregar dispositivos móveis. Dispõe de um conector USB tipo C e um conector 2 em 1, compatível com entradas micro USB e sistema operacional iOS. Fornecido em caixa de PP.

∓ Caixa: Ø53 x 20 mm

➤ **PDP** – Ø35 mm



# Adaptador 5 em 1

Para que nunca lhe falte nenhuma ligação.



IOS e USB-C



Micro USB



Tipo A



NEW

ecologic



**Rubins** — 97091

Cabo retrátil 5 em 1 em ABS e bambu. Uma das extremidades é USB-C com adaptador para USB-A, enquanto que na outra extremidade existe uma ponta especial 2 em 1 micro-usb e iOS com adaptador para USB-C. Entrada/saída: 5V/1A. Fornecido em caixa presente de papel craft.

∓ 40 x 130 mm | Cabo esticado: 40 x 850 mm

LSR - Ø30 mm



106

A



103



127

NEW

**Minsky** — 97090

Conjunto de adaptadores em alumínio composto por: 1 adaptador de USB-A para USB-C e 1 adaptador de USB-C para USB-A. Tecnologia USB 2.0. Fornecido em caixa individual em PP.

∓ 37 x 40 x 18 mm

DUV - 20 x 20 mm



119



**Shelley** — 93320

Porta cartões para celular em silicone com autocolante no verso.

∓ 57 x 87 x 3 mm

✂ SCR – 35 x 35 mm



128



106



**Carver** — 93321

Porta cartões para celular em silicone com autocolante no verso e suporte para smartphone.

∓ 57 x 96 x 5 mm

✂ PDP – 50 x 10 mm



103



**Nicolaus** — 94446

Porta cartões em silicone com cordão e suporte para celular.

∓ Porta-cartões: 57 x 86 x 4 mm | Lanyard: 420 mm

✂ SCR – 35 x 35 mm



109



**Bell** — 93264

Porta cartões para celular em PVC com autocolante.

∓ 56 x 89 x 1 mm

✂ SCR – 40 x 45 mm





# Bloqueio RFID

Garanta a segurança dos seus cartões e evite o roubo de dados.



## Muller — 93332

Porta cartões em alumínio com bloqueio de RFID e fita elástica em poliéster. O porta cartões tem acabamento mate e capacidade para 12 cartões. Seu formato compacto e funcionalidade de bloqueio RFID permitem que seja guardado de forma cómoda e segura em bolsos.

▮ 90 x 58 mm

▮ LSR – 50 x 20 mm



## Franck — 93331

Porta cartões para celular em PU com bloqueio de RFID, com capacidade para dois cartões. O porta cartões tem fita ajustável em PU e autocolante no verso.

▮ 102 x 63 x 3 mm

▮ PDP – 40 x 10 mm



## Block — 93334

Porta-cartões para celular em PU com bloqueio de RFID, capacidade para 1 cartão e autocolante no verso.

▮ 92 x 62 x 3 mm

▮ SCR – 45 x 45 mm



## Poppy — 93265

Porta cartões em PU com bloqueio de RFID e fita em poliéster para retirar facilmente seus cartões. Com capacidade para guardar até 2 cartões.

▮ 92 x 65 mm

▮ SCR – 45 x 45 mm



# Direção mais segura

Com os suportes de celular para carro.



**Uler** — 57338  
 Porta celular para carro em ABS.  
 ̄ 50 x 97 x 28 mm  
 PDP – Ø15 mm



**Wallis** — 97366  
 Porta celular para carro em ABS.  
 ̄ 40 x 78 x 25 mm  
 PDP – 33 x 9 mm



**Hooke** — 97367  
 Suporte para celular em ABS e TPR.  
 ̄ Fechado: 89 x 30 x 9 mm  
 SCR – 45 x 25 mm



**Georges** — 97150  
 Suporte de anel para celular em ABS com autocolante no verso.  
 ̄ 35 x 40 x 6 mm  
 PDP – 25 x 6 mm

# Proteja a sua privacidade com os nossos protetores para webcam

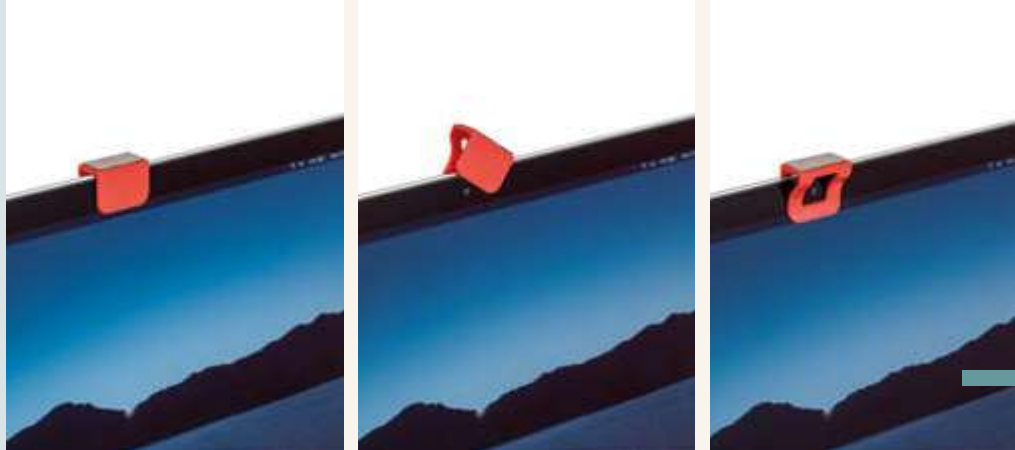

**NEW**

## Moniz — 97950

Protetor de webcam em formato clip com limpador de tela. Adequado para tablet e notebook.

▮ 24 x 12 x 22 mm |  
Limpador de tela: 22 x 10 mm

🔪 PDP – 20 x 8 mm



## Rosat — 97952

Protetor para webcam em PP com tampa deslizante e autocolante no verso. Formato universal para smartphone, tablet, notebook e computador de secretária.

▮ 42 x 17 x 2 mm | Aberto: 65 x 17 x 2 mm

🔪 PDP – 22 x 7 mm



## Galilei — 97951

Protetor para webcam em PP com tampa deslizante e autocolante no verso. Formato universal para smartphone, tablet, notebook e computador de secretária.

▮ 32 x 13 x 1,5 mm | Aberto: 43 x 13 x 1,5 mm

🔪 PDP – 25 x 8 mm





14"

**Seattle** — 92290

Pasta para notebook em soft shell de alta densidade para notebook até 14" com bolso frontal com zíper.

▮ 370 x 280 x 30 mm

▮ TRS – 220 x 100 mm

14"

**Avery** — 92352

Bolsa em soft shell para notebook até 14".

▮ 355 x 280 x 30 mm

▮ TRS – 260 x 190 mm





Escrita



# INKUOTE COLLECTION

## Para aqueles que não dispensam escrever em papel

Transpor para o papel pensamentos e ideias - o culto da escrita à mão. Instrumentos de escrita que combinam diferentes texturas num design moderno e elegante. A fluidez da tinta como ritmo da inspiração. A INKUOTE como mentora das palavras soltas e acertadas.

A

103



### Sign I 81206

Inox



A SIGN I é uma elegante esferográfica em metal, com acabamento preto mate, clipe em aço inox. A SIGN I é um objeto sofisticado e de design minimalista que tem recarga Dokumental Ink® e escrita azul. Fornecida em caixa presente.

∅10 x 135 mm | Caixa: 53 x 187 x 28 mm

LSR - 40 x 5 mm

B

103



### Sign II 81207

Inox



O SIGN II é um elegante roller em metal, com acabamento preto mate e clipe em aço inox. O SIGN II tem recarga Dokumental Ink® e que escrita preta. Fornecido em caixa presente.

∅10 x 135 mm | Caixa: 53 x 173 x 28 mm

LSR - 40 x 5 mm

C

103



### Autograph 81205

Inox



O AUTOGRAPH é um conjunto sofisticado de esferográfica e roller. O roller é em metal com acabamento preto mate e tampa com clipe em aço inox e a esferográfica é em metal, com acabamento preto mate e clipe em aço inox. Neste minimalista e requintado conjunto a esferográfica e roller têm recarga Dokumental Ink® com escrita azul. Fornecida em caixa presente.

∅10 x 135 mm | Caixa: 75 x 30 x 190 mm

LSR - 40 x 5 mm

D

127



### Stain 81208

Inox



O STAIN é um roller em metal, texturado e tampa com clipe em aço inox. O roller STAIN foi desenhado com inspiração em linhas geométricas. Contém recarga Dokumental Ink® e escrita preta. Fornecido em caixa presente.

∅10 x 135 mm | Caixa: 53 x 173 x 28 mm

LSR - 40 x 4 mm



A

B





# INKUOTE COLLECTION

A



**Neo**  
**81001**

127 103 143



A NEO é uma esferográfica vanguardista e ergonômica em alumínio, com mecanismo twist, que foi concebida a pensar nos profissionais que fazem do caderno e do tablet o seu escritório. A ponteira touch, em silicone, permite reforçar a sua utilidade e o corpo laqueado com acabamento matt/brilhante confere muita elegância. A esferográfica tem recarga em metal e tinta Dokumental® preta. Fornecida em caixa presente.

∅ 11 x 138 mm | Caixa: 55 x 30 x 190 mm

LSR - 50 x 5 mm

B



**Hook Matte**  
**81003**

147 127



A esferográfica HOOK Matte é elegante e sofisticada, que dificilmente passa despercebida. Trata-se de uma esferográfica em bronze, com mecanismo twist, cromagem brilhante e clipe com mola em ferro, que lhe garante força e flexibilidade. A ponteira em bronze com cromagem brilhante e o corpo com duplo acabamento (interior platinado e exterior laqueado mate) reforçam, não só o design elegante, como a qualidade da HOOK Matte. Tem recarga em metal G2, com tinta Dokumental® azul. Fornecida em caixa presente.

∅ 11 x 138 mm | Caixa: 187 x 53 x 28 mm

LSR - 45 x 6 mm

A



A





B

A

B



ROLLER



ESFEROGRÁFICA + ROLLER



ESFEROGRÁFICA



103



103



103



**Ezekiel Roller** — 81196

Roller em metal com clipe e acabamento em dourado. Fornecida em estojo em papel craft.

∓ Ø11 x 140 | Caixa: 180 x 57 x 25 mm

♣ LSR - 40 x 6 mm



**Ezekiel Set** — 81210

Conjunto de esferográfica com mecanismo twist e roller em metal com clipe e detalhes em dourado. Fornecido em estojo almofadado.

∓ Ø11 x 140 | Caixa: 180 x 57 x 25 mm

♣ LSR - 40 x 6 mm



**Ezekiel** — 81195

Esferográfica em metal com mecanismo twist, clipe e apontamentos em dourado. Fornecida em estojo em papel craft.

∓ Ø11 x 139 | Caixa: 180 x 43 x 22 mm

♣ LSR - 40 x 6 mm





A



Banho de ouro de 18 quilates

A



**Versailles** — 81146

Conjunto de roller e esferográfica em metal. Elementos com banho de ouro de 18 quilates. Esferográfica: Até 1,5 km de escrita. Fornecido em estojo almofadado.

∅12 x 136 mm |  
 Estojo: 185 x 75 x 31 mm  
 LSR – 35 x 5 mm



117

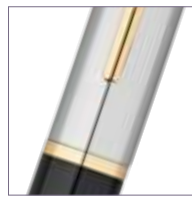

Banho de ouro de 18 quilates



**Louvre** — 91489

Esferográfica em metal. Clipe, anel e ponteira com banho de ouro de 18 quilates. Até 1,5 km de escrita. Fornecida em estojo almofadado.

∅12 x 139 mm |  
 Estojo: 179 x 56 x 30 mm  
 LSR – 25 x 6 mm



117

# Para brindes mais completos e elegantes

Os conjuntos de esferográficas e rollers são a escolha certa.



**Benton** — 51842

Conjunto de roller e esferográfica em metal, ambos com clipe e escrita a preto. A esferográfica é de mecanismo twist e permite Até 1,5 km escrita. Incluso estojo almofadado.

∅13 x 136 mm | Estojo: 185 x 75 x 31 mm

LSR – 30 x 6 mm



**Douro** — 91816

Conjunto de roller e esferográfica com mecanismo twist, ambos em metal e com clipe. Esferográfica até 2 km de escrita. Fornecido em estojo almofadado.

∅12 x 132 mm | Estojo: 170 x 70 x 30 mm

LSR – 30 x 6 mm



B



 **Warhol** — 51836

Conjunto de roller e esferográfica em metal, ambos com clipe e escrita preta. Esferográfica com mecanismo twist. Até 1,5 km de escrita. Incluso estojo almofadado.

∓ Ø13 x 135 mm |  
 Estojo: 185 x 75 x 31 mm  
 ⚡ LSR – 30 x 6 mm



147



B

 **Orlando** — 81193

Conjunto de roller e esferográfica em metal com clipe. Fornecido em estojo almofadado.

∓ Esferográfica: Ø13 x 136 mm |  
 Roller: Ø13 x 135 mm |  
 Caixa: 192 x 34 x 85 mm  
 ⚡ LSR – 40 x 6 mm



107

115





ROLLER



ESFEROGRÁFICA + ROLLER



ESFEROGRÁFICA



103

106



106



103

106



106

103



 **Caliopo Roller** — 81198

Roller em metal com clipe com detalhe brilhante na ponta. Fornecido em estojo de oferta. Escrita azul.

✂ Esferográfica: Ø10 x 136,5 mm |  
Caixa: 182 x 22 x 42 mm

✂ LSR – 25 x 3 mm

 **Caliopo Set** — 81199

Conjunto de roller e esferográfica em metal com mecanismo twist e clipe com detalhe brilhante na ponta. Fornecido em estojo almofadado.

✂ Esferográfica: Ø10 x 133 mm |  
Roller: Ø10 x 137 mm | Caixa: 180 x 57 x 25 mm

✂ LSR – 40 x 6 mm

 **Caliopo** — 81197

Esferográfica em metal com mecanismo twist e clipe com detalhe brilhante na ponta. Fornecida em estojo papel craft.

✂ Ø10 x 133 mm |  
Caixa: 180 x 43 x 22 mm

✂ LSR – 25 x 3 mm

## Caneta sem tinta

A alternativa mais inovadora às tradicionais esferográficas: permite apagar e tem uma ponta com escrita infinita.

Austen —  
51917  
📄 .158

NEW

**Monet** — 91792

Caneta sem tinta em alumínio com ponta de liga metálica com grafite capaz de durar por muito tempo. Não é necessário afiar e pode apagar o que escrever. Fornecida em caixa craft preta.

📏 Ø8 x 153 mm

✂️ PDP - 50 x 6 mm



# Conjunto de roller e esferográfica



Ponteira touch e mecanismo twist



## **Doublette** — 91844

Conjunto de roller e esferográfica em metal com ponteira touch e clipe. Esferográfica com mecanismo twist e até 1,5 km de escrita. Fornecida em estojo almofadado.

Esferográfica: Ø11 x 128,6 mm | Roller: Ø11 x 131,4 mm | Estojo: 175 x 55 x 25 mm

LSR – 35 x 5 mm



## **Haley** — 91899

Conjunto de roller e esferográfica em alumínio com clipe. Esferográfica até 1,5 km de escrita. Fornecido em estojo almofadado.

Esferográfica: Ø11 x 138 mm | Estojo: 175 x 55 x 25 mm

LSR – 35 x 5 mm



# Conjunto de esferográfica e lapiseira



Esferográfica



Lapiseira

## **Plock** — 91834

Conjunto de esferográfica e lapiseira em alumínio. Esferográfica até 1,5 km de escrita. Lapiseira com grafite 0.5 mm. Incluso estojo.

Esferográfica: Ø11 x 137 mm | Estojo: 165 x 50 x 24 mm

LSR – 70 x 6 mm





107 106 103



 **Bern** — 91428

Roller em metal com clipe. Escrita a preto.  
Fornecido em estojo presente almofadado.  
∓ Ø12 x 136 mm | Estojo: 175 x 55 x 25 mm  
▸ LSR - 30 x 7 mm



**A**



 **Blazon** — 81147

Roller em metal com suave relevo no corpo.  
Fornecido em estojo presente almofadado.  
Escrita preta.  
∓ Ø11 x 137 mm | Estojo: 179 x 55 x 30 mm  
▸ LSR - 35 x 5 mm





 **Silverio** — 81170  
 Esferográfica em metal com corpo brilhante e clipe. Fornecida em estojo almofadado.  
 ∅10 x 131 mm | Caixa: 182 x 22 x 42 mm  
 LSR – 35 x 6 mm



 **Plata** — 91008  
 Esferográfica em metal até 2 km de escrita. Incluso embalagem de veludo.  
 ∅10 x 140 mm | Embalagem de veludo: 160 x 30 mm  
 LSR – 30 x 5 mm

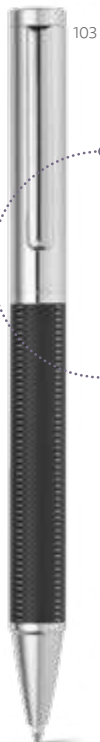

Mecanismo twist



 **Montreal** — 51348  
 Esferográfica em metal com mecanismo twist e clipe. Até 2 km de escrita. Incluso embalagem de veludo.  
 ∅11 x 138 mm | Embalagem de veludo: 160 x 30 mm  
 LSR – 40 x 7 mm



Mecanismo twist



 **Deli** — 91814  
 Esferográfica em metal. Até 1,5 km de escrita. Incluso embalagem de veludo.  
 ∅12 x 135 mm | Embalagem de veludo: 160 x 30 mm  
 LSR – 30 x 5 mm

# Elegância multifuncional

Muito mais do que escrever, estas esferográficas têm várias funções para que nada fique por fazer.



A



## Lapoint — 81201



Esferográfica multifunções em metal com clipe. Esferográfica com mini lanterna LED, apontador laser e ponteira touch. Incluso 3 pilhas LR41. Fornecida em estojo metálico com forro de veludo.



∅10 x 125 mm | Caixa: 178 x 38 x 19 mm

LSR – 80 x 25 mm



127



Ponteira laser

Ponteira touch



Ponteira laser e LED



B



## Ebre — 91821



Esferográfica em metal. Com ponteira laser e LED. Incluso 3 pilhas LR41. Até 1,5 km de escrita. Fornecida em estojo com forro de veludo.



∅10 x 131 mm | Estojo: 170 x 50 x 20 mm

LSR – 35 x 5 mm



127



3 cores distintas



Lapiseira



## Sketch — 91843



Esferográfica multifunções em metal com diferentes possibilidades de escrita: lapiseira com grafite 0,5 mm, escrita a vermelho, azul ou preto. Esferográfica até 2 km de escrita. Fornecida em estojo almofadado.

∅10 x 132 mm | Estojo: 150 x 43 x 24 mm

LSR – 50 x 5 mm



103





Mecanismo twist

A

B



112

A

112 167 137 106



**Clare** — 81156

Esferográfica em alumínio com mecanismo twist e clipe. Disponível em elegantes cores. Até 2 km de escrita.

∅10 x 140 mm

PDP = 50 x 6 mm



137

B

137 124 127 103



**Lea** — 51125

Esferográfica em alumínio com acabamento matt. Até 1,5 km de escrita.

∅10 x 137 mm

LSR = 50 x 6 mm



## Ponteira touch e mecanismo twist



**NEW**



**Julie** — 81144

Esferográfica em metal com ponteira touch. Fornecida com estojo de oferta desmontado.

∓ ∅10 x 141 mm |

Estojo: 150 x 15 x 19 mm

↗ LSR – 35 x 5 mm

## Ponteira touch e mecanismo twist



**Touch** — 51437

Roller em metal com corpo brilhante e detalhes em cromado. O detalhe da ponteira touch torna este brinde sofisticado e adaptável às novas tecnologias. Escrita preta. Fornecido com estojo presente desmontado.

∓ ∅9 x 141 mm |

Estojo: 150 x 15 x 19 mm

↗ LSR – 40 x 5 mm

Ponteira touch



**Wass Touch** — 81005

Esferográfica em alumínio com mecanismo twist com ponteira touch em silicone. Até 2 km de escrita. Fornecida em caixa presente.

∓ ∅10 x 142 mm |

Caixa: 175 x 41 x 20 mm

↗ LSR – 40 x 5 mm

# Ponteiras Touch

Concebidas para quem adora o mundo digital, estas esferográficas ajudam-no a manter os seus ecrãs limpos e sem marcas.

Ponteira touch e mecanismo twist



Mecanismo twist



 **Script** — 91494  
Esferográfica em alumínio com mecanismo twist, ponteira touch e clipe. Até 1,5 km de escrita.  
∅ 11 x 135 mm  
LSR – 60 x 5 mm

 **Sinatra** — 51837  
Esferográfica em alumínio com mecanismo twist, ponteira touch e clipe. Até 2 km de escrita. Incluso embalagem de veludo.  
∅ 11 x 138 mm | Embalagem de veludo: 160 x 30 mm  
LSR – 25 x 5 mm



 **Shanghai** — 91476  
Esferográfica em alumínio com ponteira touch. Até 2 km de escrita.  
∅ 11 x 140 mm  
LSR – 70 x 6 mm



 **Halos** — 91629  
Esferográfica em alumínio com ponteira touch. Até 1,5 km de escrita.  
∅ 9 x 138 mm  
LSR – 60 x 5 mm





 Tratamento antibacteriano  
**ISO 22196**



A

Mecanismo twist

NEW

 **Kaylum** — 91791

Esferográfica em alumínio com tratamento antibacteriano, segundo a certificação ISO22196. Mecanismo twist, clipe e ponteira touch.

∅ 7 x 132 mm

LSR — 45 x 5 mm



Mecanismo twist

 **Miro** — 91444

Esferográfica em alumínio com mecanismo twist, clipe e ponteira touch.

∅ 8 x 137 mm

LSR — 45 x 4 mm



Mecanismo twist

 **Zoe** — 91624

Esferográfica em alumínio com mecanismo twist, clipe e ponteira touch.

∅ 8 x 135 mm

LSR — 50 x 5 mm





106



106

127

103

 **Daney** — 81155  
 Roller em alumínio com clipe.  
 Escrita preta.  
 ∅10 x 136 mm  
 LSR – 50 x 6 mm



147



147

127

106

103

 **Lyme** — 91338  
 Esferográfica em alumínio.  
 Até 1,5 km de escrita.  
 ∅12 x 138 mm  
 LSR – 40 x 7 mm



127



103

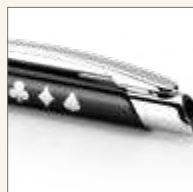

 **Serrat** — 91392  
 Esferográfica em alumínio.  
 Até 1,5 km de escrita.  
 ∅9 x 140 mm  
 LSR – 90 x 5 mm



127



147



103

 **Edge** — 81126  
 Esferográfica em alumínio com clipe flexível.  
 Até 1,5 km de escrita.  
 ∅10 x 147 mm  
 LSR – 60 x 6 mm

Mecanismo  
twist



**Wass** — 81000

Esferográfica em alumínio com mecanismo twist, clipe em ferro com cromagem brilhante. Até 2 km de escrita. Fornecida em caixa presente.

∅ 10 x 138 mm | Caixa: 175 x 41 x 20 mm

LSR - 40 x 5 mm



Mecanismo  
twist

**Lesley Metallic** — 81185

Esferográfica em metal com clipe.

∅ 7 x 129 mm

LSR - 40 x 4 mm







A



104

A

104 106 103



**Lando Roller** — 81191

Roller em alumínio com clipe.  
Escrita azul.  
∅ 11 x 140 mm  
LSR – 45 x 7 mm

Mecanismo twist



106

106 103 104



**Lando** — 81190

Esferográfica em alumínio com mecanismo twist e clipe.  
∅ 11 x 140 mm  
LSR – 35 x 6 mm



127

127 106 103 104



**Avila** — 91492

Esferográfica em alumínio com clipe de metal.  
Até 1,5 km de escrita.  
∅ 9 x 139 mm  
LSR – 60 x 5 mm



### Alps — 91333

Esferográfica em alumínio até 2 km de escrita.  
Incluso embalagem de veludo.

∅ 11 x 136 mm |  
Embalagem de veludo: 160 x 30 mm  
LSR - 60 x 5 mm



114 127 147 103



### Mare — 91434

Esferográfica em alumínio.  
Até 1,5 km de escrita.

∅ 10 x 133 mm  
LSR - 70 x 7 mm



### Dante — 91491

Esferográfica em alumínio com clipe  
de metal e grip. Até 1,5 km de escrita.

∅ 10 x 136 mm  
LSR - 50 x 5 mm



A



**Joan** — 91694

Esferográfica em alumínio com acabamento mate e botão com acabamento brilhante. Corpo com duplo acabamento.

∅ 10 x 140 mm

LSR – 70 x 6 mm

# Efeito laser colorido

Grave a laser e combine sua criatividade com a cor do botão! Combinações que valorizam sua marca!



A

Gravação a laser mostra a cor do botão



**Inky** — 91847

Esferográfica em alumínio. Até 1,5 km de escrita.

∅ 11 x 139 mm

LSR – 65 x 5 mm





Acabamento emborrachado



**Olaf Soft** — 81192

Esferográfica em alumínio com acabamento emborrachado e clipe.

∅10 x 137 mm

LSR - 55 x 6 mm



Acabamento emborrachado



**Poppins** — 51140

Esferográfica em alumínio com corpo colorido e acabamento emborrachado. Até 1,5 km de escrita.

∅10 x 137 mm

LSR - 50 x 5 mm



Acabamento emborrachado



**Beta Soft** — 81141

Esferográfica em alumínio e acabamento emborrachado. Até 1,5 km de escrita.

∅10 x 137 mm

LSR - 55 x 6 mm

# Torne a sua oferta ainda mais especial

A experiência de receber um presente é mais marcante se existir um momento de expectativa e curiosidade. Reforce a ligação à sua marca e demonstre toda a sua dedicação!



## Lello — 91973

Estojo em cartão para 1 esferográfica.  
Fornecido desmontado.

☒ 150 x 15 x 19 mm

✂ SCR – 120 x 10 mm



## Vila — 91960

Embalagem em veludo para 1 esferográfica.  
Esferográfica não inclusa.

☒ 160 x 30 mm

✂ TRS – 90 x 15 mm



## Abe — 91968

Embalagem em cartão para 1 esferográfica.

☒ 155 x 40 mm

✂ SCR – 120 x 25 mm

**Speare** — 91969

Estojo em cartão para 1 esferográfica. Interior com elegante almofada em veludo.

☒ 170 x 50 x 28 mm

🔪 SCR - 140 x 35 mm



**Casie** — 91955

Estojo em cartão para 1 esferográfica. Interior com elegante almofada em veludo.

☒ 175 x 55 x 25 mm

🔪 SCR - 140 x 40 mm

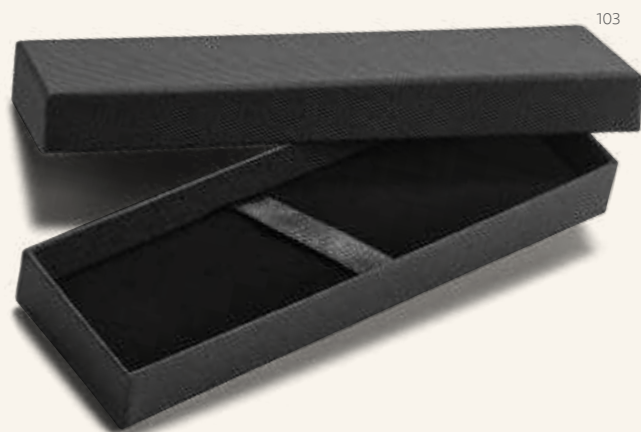

**Pendulo** — 91970

Estojo em papel craft para 1 esferográfica.

☒ 180 x 43 x 22 mm

🔪 SCR - 150 x 25 mm







A

B



A

**ECologic**



**Cork** — 81401



Esferográfica em cortiça e metal inspirada no sobreiro com mecanismo twist e clipe. Até 1,5 km de escrita. Fornecida em estojo almofadado com detalhe em cortiça.

∅11 x 137 mm | Estojo: 180 x 56 x 30 mm

LSR - 40 x 6 mm



**Lavre** — 93324

.232



B

**ECologic**



**Natura** — 91647



Esferográfica em cortiça e alumínio com clipe. Até 1,5 km de escrita. Fornecida com embalagem presente em cartão.

∅9 x 139 mm | Bolsa: 155 x 40 mm

LSR - 85 x 5 mm

# Ajudar o ambiente, uma esferográfica de cada vez

A nossa gama de esferográficas ECOlogic apresenta uma grande variedade de materiais sustentáveis, combinando o respeito pelo ambiente com a funcionalidade.

• Clipe de grandes dimensões para personalização

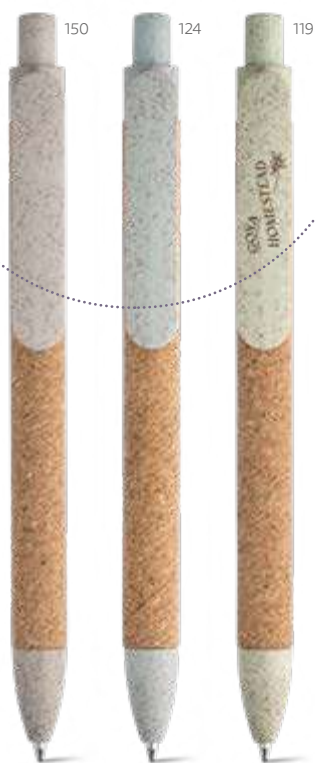

C

NEW

ECOlogic



**Goya** — 91795



Esferográfica em cortiça com clipe e elementos coloridos em fibra de trigo e PP.

∅ 11 x 140 mm

LSR - 85 x 5 mm







## Bambu e fibra de palha de trigo



**Eco**logic



**Kuma** — 81013



Esferográfica em bambu com clipe, antideslizante e elementos coloridos em fibra de trigo e ABS. Até 1,5 km de escrita.

∅ 11 x 142 mm

PDP – 50 x 6 mm



# Conjugu a durabilidade do bambu com uma escrita sustentável



A

NEW

**ECÓlogic**

 **Bahia** — 91820

 Esferográfica em bambu com mecanismo twist e clipe em metal. Fornecida em estojo de bambu. Esferográfica amiga do ambiente.

∓ Ø11 x 140 mm | Estojo: 170 x 40 x 25 mm

✂ LSR – 35 x 6 mm



**ECÓlogic**

 **Elliot** — 81009

 Esferográfica em bambu com clipe de metal. Até 1,5 km de escrita.

∓ Ø11 x 137 mm

✂ PDP – 50 x 6 mm



**ECÓlogic**

 **Nicole** — 81010

 Esferográfica em bambu com clipe de metal. Até 1,5 km de escrita.

∓ Ø13 x 143 mm

✂ PDP – 35 x 6 mm



**ECÓlogic**

 **Beta Bamboo** — 81011

 Esferográfica em bambu com clipe de metal. Até 1,5 km de escrita.

∓ Ø11 x 141 mm

✂ PDP – 50 x 6 mm



160



**EcoLogic**



**Greeny** — 81162



Conjunto de esferográfica e lapiseira em bambu. Esferográfica até 1,5 km de escrita. Lapiseira com grafite 0.7. Fornecida em estojo de cartão.



∅ 11 x 138 mm | Estojo: 171 x 53 x 23 mm

SCR - 60 x 20 mm



160



**EcoLogic**



**Hera** — 81163



Esferográfica em bambu com clipe em metal. Até 1,5 km de escrita.

∅ 11 x 138 mm

PDP - 50 x 7 mm







108 119 114 128 150 103



**ECÓlogic**

 **Benjamin** — 81012

 Esferográfica em bambu com ponteira touch e clipe em metal. Os elementos coloridos são em fibra de trigo e ABS. Até 1,5 km de escrita.

∅11 x 139 mm

PDP – 60 x 6 mm



114 119 105 150 103



**ECÓlogic**

 **Volter** — 81014

 Esferográfica em bambu e clipe em metal. Os elementos coloridos são em fibra de trigo e ABS. Até 1,5 km de escrita.

∅11 x 142 mm

PDP – 60 x 6 mm







Slow down and enjoy  
the simple pleasures in life



103



### ECologic



**Leaf** — 91846

Conjunto de esferográfica e lapiseira em papel craft com clipe e ponteira de plástico. A lapiseira é de 0.5 mm. Fornecido com uma bolsa em cartão.

∅10 x 138 mm | Bolsa: 175 x 55 mm

PDP – 50 x 5 mm



160

### ECologic



**Masai** — 91383

Esferográfica em papel craft com clipe de plástico. Até 1,5 km de escrita.

∅10 x 140 mm

PDP – 50 x 7 mm



### ecologic

 **Bambu** — 91378

 Esferográfica em bambu com clipe de plástico.

∓ Ø11 x 142 mm

♣ LSR – 80 x 6 mm



NEW

### ecologic

 **Pati** — 81153

 Esferográfica em bambu com antideslizante e com clipe e ponteira de plástico.

∓ Ø11 x 142 mm

♣ PDP – 50 x 7 mm



Interior em papel de jornal reciclado

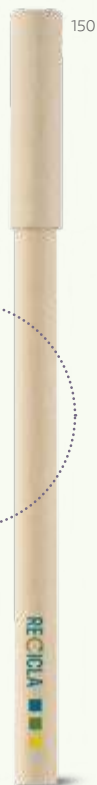

NEW

### ecologic

 **Recicla** — 91290

 Esferográfica com tampa em papel craft e interior em papel de jornal reciclado. Esferográfica amiga do ambiente.

∓ Ø6 x 145 mm

♣ PDP – 60 x 5 mm

NEW

### ecologic

 **Bio** — 91291

 Esferográfica em madeira com tampa transparente. Esferográfica amiga do ambiente.

∓ Ø10 x 150 mm

♣ PDP – 60 x 6 mm





**Design inovador e arrojado  
com o selo de qualidade  
Made in Italy**

Writing instruments  
since 1970

**Todas as esferográficas  
com pelos menos  
1.500m de escrita  
e tinta dokumental®.**





## Evo

A leveza das suas linhas e as cores sóbrias em que se apresentam transmitem uma confiança ímpar. Protagonistas ilustres em qualquer espaço, vão fazer incidir na sua marca elegância e prestígio.



 **Evo Mm** — 31013

Esferográfica com acabamento metalizado e ponteira de metal. Tinta Dokumental® até 2,5 km de escrita.

∅ 9 x 140 mm

➤ PDP – 50 x 5 mm



• Acabamento metalizado



 **Wave Mm** — 31010

Esferográfica com acabamento metalizado e tinta Dokumental® até 2 km de escrita.

∅ 9 x 140 mm

 PDP - 50 x 5 mm



• Acabamento brilhante



 **Wave Cc** — 31011

Esferográfica com acabamento brilhante e tinta Dokumental® até 2 km de escrita.

∅ 9 x 140 mm

 PDP - 50 x 5 mm

• Acabamento frost



 **Wave Frost** — 31012

Esferográfica com acabamento frost e tinta Dokumental® até 2 km de escrita.

∅ 9 x 140 mm

 PDP - 50 x 5 mm



# Esferográficas produzidas a partir de ABS 100% reciclado

**ECO**logic

**Tilt Eco** — 31020

Esferográfica reciclada eco com acabamento matt e tinta Dokumental® até 2 km de escrita.

∅10 x 135 mm

PDP – 40 x 6 mm

**ECO**logic

**New Star Eco** — 31022

Esferográfica reciclada eco com acabamento matt e tinta Dokumental® até 2 km de escrita.

∅10 x 140 mm

PDP – 45 x 5 mm



**Tilt Bc** — 31018

Esferográfica com acabamento brilhante, ponteira colorida e tinta Dokumental® até 2 km de escrita.

∅10 x 135 mm

PDP – 40 x 6 mm

Ponteira frost colorida



**Tilt Bt** — 31019

Esferográfica com acabamento brilhante, ponteira frost colorida e tinta Dokumental® até 2 km de escrita.

∅10 x 135 mm

PDP – 40 x 6 mm



# • Top Pen •

**Design e diversidade  
que marcam a diferença.**

Ideais para grandes campanhas.

As esferográficas Top Pen conjugam um design moderno e cores arrojadas com uma ótima relação qualidade-preço. Todos os nossos modelos são ergonômicos, proporcionando uma escrita suave e confortável.

Com as generosas áreas de personalização destas esferográficas, a sua marca tem tudo o que precisa para brilhar!

**Todas as esferográficas com pelo menos  
1.200m de escrita.**





**Ross** — 81106

Esferográfica em ABS com acabamento brilhante.  
Ponteira cromada e clipe de grande dimensão.  
Até 1,5 km de escrita.

∅12 x 142 mm

▀ SRC – 40 x 25 mm



A

B



104

A

104 102 105 128 108 119 109 124 103



**Caribe** — 51256

Esferográfica em ABS com grip, acabamento brilhante e ponteira cromada. Até 1,5 km de escrita.

∅10 x 138 mm

PDP - 40 x 6 mm



124

B

124 104 128 105 109 103



**Caribe White** — 81104

Esferográfica em ABS com grip e acabamento brilhante. Ponteira cromada. Até 1,5 km de escrita.

∅11 x 140 mm

PDP - 40 x 6 mm





Acabamento translúcido e mecanismo twist



119 104 132 105 103



 **Sally Frost** — 81108

Esferográfica em ABS com acabamento translúcido e mecanismo twist. Até 1,5 km de escrita.

∅10 x 136 mm

SRC – 40 x 23 mm

109 124 104 105 128 103



 **Dara** — 81100

Esferográfica em ABS com acabamento brilhante. Até 1,5 km de escrita.

∅9 x 140 mm

SRC – 45 x 20 mm



Acabamento brilhante e mecanismo twist

124 104 105 108 119 106 103





 **Sally** — 81107

Esferográfica em ABS com acabamento brilhante e mecanismo twist. Até 1,5 km de escrita.

∅10 x 136 mm

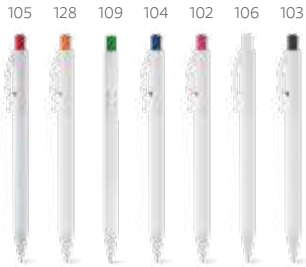
SRC – 40 x 23 mm



 **Lana White** — 81123  
 Esferográfica em ABS com acabamento brilhante e mecanismo colorido.  
 Até 1,5 km de escrita.  
 ∅ 9 x 141 mm  
 SRC - 45 x 15 mm



 **Lana** — 81122  
 Esferográfica em ABS com acabamento brilhante.  
 Até 1,5 km de escrita.  
 ∅ 9 x 141 mm  
 SRC - 45 x 15 mm



• Acabamento translúcido

 **Lana Frost** — 81124  
 Esferográfica em ABS com acabamento translúcido.  
 Até 1,5 km de escrita.  
 ∅ 9 x 141 mm  
 SRC - 45 x 15 mm



• **Corpo triangular**



**Roy — 81121**

Esferográfica em ABS com grip, acabamento brilhante e corpo triangular. Até 1,5 km de escrita.

∅ 9 x 141 mm

➤ PDP – 60 x 5 mm



# Esferográficas com tampa com acabamento à sua escolha: frost ou matt



Acabamento  
frost

 **Kate** — 81116

Esferográfica em PP com acabamento frost. Até 1,5 km de escrita.

∅ 8 x 151 mm

▀ SRC - 45 x 15 mm



Acabamento  
frost

 **Amy** — 81115

Esferográfica em PP com acabamento frost. Até 1,5 km de escrita.

∅ 8 x 151 mm

▀ SRC - 45 x 15 mm



Acabamento  
frost

 **Kate Bk** — 81117

Esferográfica em PP com acabamento frost. Até 1,5 km de escrita.

∅ 8 x 151 mm

▀ SRC - 45 x 25 mm

Acabamento  
frost



**Milu Frost** — 81109

Esferográfica em PP  
e acabamento frost.  
Até 1,5 km de escrita.

∅10 x 142 mm

SRC – 45 x 25 mm



Acabamento  
matt



**Milu** — 81113

Esferográfica em PP  
com acabamento matt.  
Até 1,5 km de escrita.

∅10 x 142 mm

SRC – 45 x 25 mm



## Esferográficas com tampa com acabamento brilhante



**Marley** — 81118

Esferográfica em PP com acabamento brilhante. Até 1,5 km de escrita.

∅ 8 x 151 mm

SRC - 45 x 15 mm



**Jacky Bk** — 81120

Esferográfica em PP com acabamento brilhante. Até 1,5 km de escrita.

∅ 8 x 151 mm

SRC - 45 x 15 mm





**Jacky** — 81119

Esferográfica em PP com acabamento brilhante.  
Até 1,5 km de escrita.

∅ 8 x 151 mm

SRC - 45 x 15 mm



103

106

104

124

132

105

128

108

119

109

**Ateneo** — 51736Lápis com borracha.  
Grau de dureza: HB.

∅ 7 x 190 mm

PDP – 40 x 5 mm



103

**Ernster** — 51721Lápis apontado com borracha.  
Grau de dureza: HB.

∅ 7 x 190 mm

PDP – 40 x 5 mm



150

**Cornwell** — 51716Lápis apontado com borracha.  
Grau de dureza: HB.

∅ 7 x 190 mm

PDP – 40 x 5 mm

Mini  
lápis

150

**Barter** — 51759Mini lápis afiado com borracha.  
Grau de dureza: HB.

∅ 7 x 100 mm

PDP – 40 x 5 mm



**Rizzoli** — 51738

Lápis apontado. Grau de dureza: HB.

∅ 8 x 175 mm

➤ PDP - 40 x 5 mm



**Rhombus** — 51932

Kit de escrita composto por régua de 16,5 cm, 2 lápis de grafite, 1 borracha e 1 apontador. Fornecido com bolsa em cartão.

∅ Bolsa: 190 x 45 x 20 mm

➤ SCR - 170 x 30 mm





A



**Aguza** —  
53621  
📄 .375



**Schooli** —  
93607  
📄 .377



103



104



106



105



108



128



119



124

A

**Siza** — 51935

Borracha em TPR com capa protetora em PP.

⊥ 55 x 33 x 13 mm

🔪 PDP – 20 x 15 mm



106



103

**Austen** — 51917

Borracha branca em TPR.

⊥ 55 x 22 x 12 mm

🔪 SCR – 45 x 10 mm



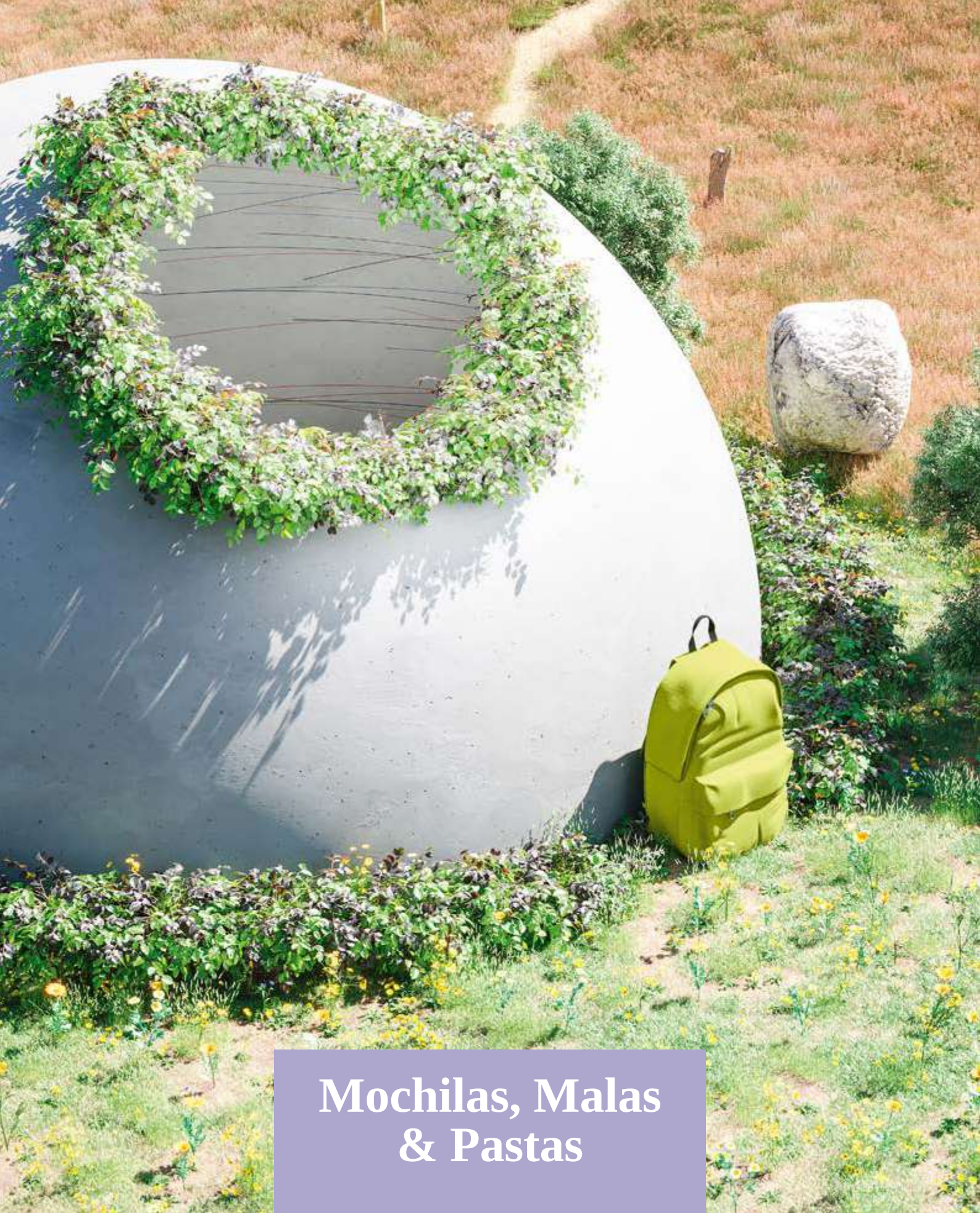

**Mochilas, Malas  
& Pastas**





# BRANVE®

O magnetismo das personalidades fortes e a capacidade de combinar consigo. De design cosmopolita e carácter vincado, a BRANVE® é contemporaneidade e inovação. Conforto, durabilidade e elegância aliadas à praticidade – para quem procura o luxo da funcionalidade em cada detalhe.

## THE BRAND THAT MATCHES

---

Saiba mais online

[branve.com](http://branve.com)

EUROPEAN  
DESIGN

HIGH QUALITY  
STANDARDS

Encontre outros produtos BRANVE®

 .20 Escritório

 .108 Escrita



# DYNAMIC COLLECTION

## Para os dinâmicos com mais estilo

Negócios e lazer podem andar de mãos dadas. Importa manter o ritmo frenético cosmopolita e o segredo é a multifuncionalidade. Ser versátil é saber conjugar o improvável – a robustez e a harmonia, a praticidade e a nobreza de materiais. Na Dynamic, os objetos multiplicam-se mas são, simultaneamente, unos: é energia em movimento.

Encontre o bloco de notas DYNAMIC 93597

 .25



15,6"

### **Dynamic Backpack I 92682**

104



10,5"

A DYNAMIC Backpack é uma mochila urbana que se distingue pela sua versatilidade e dualidade. O seu design eficiente permite-lhe que seja um objeto único e versátil que se multiplica discretamente numa mochila e numa sacola de viagem. A mochila em c.sintético 1680D tem dois bolsos no interior, que permitem proteger seu notebook até 15.6" e seu tablet até 10.5". A espaçosa sacola de viagem permite organizar na perfeição sua roupa para uma viagem de 2 ou 3 dias. Possui bolso antirroubo na parte posterior e fechos com banda elástica com placa em PU. A DYNAMIC Backpack tem ainda um encaixe para trolley que sublinha o seu lado prático e funcional. As duas partes desta mochila, podem ser usadas separadamente ou como uma peça única. Fornecida em sacola de non-woven.

± 300 x 420 x 200 mm | Mochila: 300 x 420 x 75 mm |

Sacola de viagem: 300 x 420 x 130 mm |

Sacola em Non-woven: 550 x 580 x 210 mm

➤ LSR – 40 x 10 mm



Mochila 2 em 1



Compartimentos para portátil, tablet e outros objetos





Fecho inovador ideal para personalizar

Base resistente e duradoura

103

14" **Empire Backpack**  
92680



A mochila EMPIRE é sofisticada e construída em c.sintético texturado de elevada qualidade. O compartimento principal é composto por 2 divisórias almofadadas, compatíveis com notebook até 14" e tablet até 10.5", e diversos bolsos que facilitam a arrumação. Na parte frontal, existe mais um bolso grande. Os fechos laterais têm imã resistente e placas metálicas ideais para personalização. A parte posterior, com sistema de apoio acolchoado para as costas e as alças totalmente almofadadas, garante máximo conforto e os cantos inferiores reforçados asseguram durabilidade. Contém bolsos interiores e fecho. A mochila EMPIRE tem banda para transporte em trolley, o que a torna num objeto versátil e prático tanto para o dia-a-dia como para viagens de negócios. Fornecida em sacola de non-woven.

☒ Mochila: 290 x 370 x 90 mm | Sacola de non-woven: 500 x 500 x 80 mm  
☑ LSR - 15 x 15 mm



Fecho inovador ideal para personalizar



Base resistente e duradoura



Base resistente e duradoura



Várias possibilidades para transportar

**A**

**B**

15,6" **Empire Suitcase II**  
**92359**

103



A EMPIRE II é uma pasta clássica e sofisticada, que contém dois bolsos idealizados para proteger o seu notebook até 15.6" e o seu tablet até 10.5". O seu design, tal como todos os produtos desta linha, foi pensado ao mais ínfimo pormenor e todos os detalhes fazem com que a pasta EMPIRE II seja o objeto ideal para o dia-a-dia, que não passa despercebido. O acabamento da EMPIRE II é em c.sintético texturado de alta qualidade. A versatilidade que se denota nas diferentes formas de transporte, é igualmente perceptível no seu encaixe para trolley. Fornecida em sacola de non-woven.

✂ EMPIRE SUITCASE II: 380 x 280 x 80 mm |  
Sacola em non-woven: 500 x 500 x 80 mm  
✂ LSR - 15 x 15 mm

14" **Empire Suitcase I**  
**92360**

103



A EMPIRE I é uma pasta executiva moderna com toque de sofisticação, em polípele texturado de elevada qualidade. Possui um compartimento principal com 2 bolsos almofadados, que permitem guardar seu notebook até 14" e seu tablet até 10.5". As diferentes formas de transportar a pasta tornam-na um objeto versátil, algo que é reforçado pelo seu encaixe para trolley. O fecho inovador com imã que a EMPIRE I tem na lateral elevam a pasta a um objeto único. Todos os pormenores são focados tanto na sua funcionalidade como na sua estética e exemplo disso são os detalhes metálicos usados na alça, que além de assegurarem a qualidade da EMPIRE I, garantem a sua unicidade. Fornecida em sacola de non-woven.

✂ 370 x 270 x 80 mm | Sacola em non-woven: 530 x 500 x 80 mm  
✂ LSR - 15 x 15 mm



# DIVERSITY COLLECTION

## A linha que se adapta à diversidade urbana

A rotina citadina exige flexibilidade. Assumindo um estilo alternativo e arrojado, a linha DIVERSITY está preparada para todas as peripécias do dia a dia, encarando-as com entusiasmo, leveza e a dose certa de sobriedade. Peças trendy para quem está sempre pronto para a mudança.



Material impermeável  
e fechos protetores



104



133

14"

10,5"

### Urban Backpack 92683

104

133



A URBAN é uma mochila versátil em soft shell de alta densidade e tarpaulin. Desenhada para guardar um notebook até 14" e tablet 10,5". A impermeabilidade da URBAN tornam-na um objeto único. A impermeabilidade surge, tanto no seu tecido, como no design do zíper que protege o interior da mochila. O bolso frontal é espaçoso e de acesso intuitivo e rápido. As alças ajustáveis e a pega de mão, contribuem para a versatilidade da mochila. Fornecida em sacola de non-woven.

‡ Mochila: 400 x 300 x 70 mm |  
Sacola de non-woven: 530 x 500 x 80 mm  
↗ TRS – 140 x 40 mm

# MOTION COLLECTION



Bolso extra



Alças ajustáveis



Alças ajustáveis



15,6" **Motion Backpack**  
**92681**

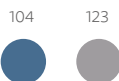

A MOTION é uma mochila com design irreverente e único em 600D e c.sintético de alta qualidade. A mochila tem diversos compartimentos, bolsos no seu interior e dois bolsos almofadados desenhados propositadamente para proteger um notebook de 15.6" e o tablet de 10.5". As alças e parte posterior almofadadas acentuam o conforto desta mochila. O encaixe para trolley é mais uma característica que enfatiza o lado prático desta mochila agilizando o seu transporte. O bolso frontal com pala e os bolsos laterais são igualmente únicos pelo seu desenho, desde a assimetria do bolso frontal ao escondido bolso na lateral que permite guardar uma garrafa de água. Fornecida em sacola de non-woven.

‡ MOTION BACKPACK: 410 x 330 x 150 mm |

Sacola em non-woven: 500 x 500 x 80 mm

♣ SCR – 40 x 10 mm

104 123 **Motion Bag**  
**92521**

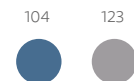

A MOTION BAG é uma sacola de viagem prática e elegante, em 600D catiónico e c.sintético de alta qualidade. O compartimento principal espaçoso é ideal para guardar roupa e outros utilitários necessários para viagens curtas. Possui ainda quatro bolsos no interior e bolso frontal com uma pala de desenho assimétrico, que caracteriza esta linha e lhe confere um design moderno. Fecha com ímã. A praticidade desta sacola é acompanhada por um design pormenorizado e cuidado que conduzem a detalhes como o espaço para colocar a etiqueta de nome, os pés metálicos que protegem a sacola, o desenho do fecho que permite ser controlado por cadeado (não incluso). As alças são desenhadas para serem ajustáveis e confortáveis. Fornecida em sacola de non-woven.

‡ 500 x 300 x 250 mm |

Sacola em non-woven: 700 x 450 x 75 mm

♣ SCR – 40 x 10 mm





A



# Viaje em primeira classe

Malas modernas que garantem uma utilização prática, mantendo seus objetos pessoais em segurança.



A

NEW



**Coimbra** — 92090

15,6"

Mala de viagem executivo em ABS e 600D com 4 rodas duplas giratórias, interior forrado e pega extensível em alumínio com altura até 460 mm. Compartimento almofadado para notebook até 15,6" e 2 bolsos frontais. Contém fecho de segurança com senha na lateral. Com placa preta de personalização. Capacidade até 33 L e peso de 1,67Kg.

☒ 320 x 540 x 210 mm

🚚 LSR – 35 x 15 mm

33 L

103

Placa para personalização



Placa para personalização



35 L

103



**Uruguay** — 92140

17"

Mala de viagem executivo em ABS com compartimento frontal para notebook 17" e interior forrado. 4 rodas giratórias, pega extensível em alumínio, com mola (altura da pega estendida até 480 mm) e placa metálica removível, para fácil gravação. Mala com capacidade até 35 L e peso de 2,70 kg.

☒ 340 x 545 x 245 mm | Placa: 31 x 31 mm

🚚 LSR – 23 x 23 mm



Placa para personalização



31 L

103



**Vigo** — 92144

Mala de viagem executivo em ABS com interior forrado, com divisória. Fecho de segurança com senha na lateral, 4 rodas giratórias, pega extensível em alumínio, com mola (altura da pega estendida até 500 mm), e placa metálica removível com imã, para fácil gravação. Mala com capacidade até 31 L e peso de 2,25 kg.

☒ 355 x 550 x 200 mm | Placa: 50 x 20 mm

🚚 LSR – 37 x 12 mm

33 L



104



103



### Perth — 92160

Mala de viagem executivo em ABS e PC com interior forrado, com divisória. Fecho de segurança com senha na lateral, 4 rodas duplas giratórias e pega extensível em alumínio, com mola (altura pega estendida até 510 mm). A mala tem capacidade até 33 L e peso de 2,70 kg.

↕ 335 x 550 x 230 mm

↗ TXP – 160 x 100 mm

34 L



104



103



Placa para personalização



Fecho de segurança



Rodas duplas giratórias

A

### Hamburg — 92185

Mala de viagem executiva em ABS com divisória e interior forrado. Fecho de segurança com senha na lateral, 4 rodas duplas giratórias e pega extensível em metal (altura até 530 mm), com mola e placa metálica removível, para fácil gravação. Capacidade até 34 L e peso de 2,50 kg.

↕ 345 x 540 x 220 mm | Placa: 60 x 20 mm

↗ LSR – 30 x 5 mm



A



Placa para personalização



127



103



B

33 L

127



### Bruges 33L — 92159

Mala de viagem executivo em ABS e PET com interior forrado, com divisória. Fecho de segurança com senha na lateral, 4 rodas duplas giratórias, pega extensível em alumínio, com mola (altura pega estendida até 530 mm) e placa metálica removível, para fácil gravação. Mala com capacidade até 33 L e peso de 2,70 kg.

▮ 335 x 540 x 225 mm | Placa: 60 x 30 mm

➤ LSR – 50 x 22 mm

XXL

90 L

103



Placa para personalização



### Bruges 90L — 92297

Mala de viagem executivo em ABS e PET com interior forrado, com divisória. Fecho de segurança com senha na lateral, 4 rodas duplas giratórias, pega extensível em alumínio, com mola (altura pega estendida: 335 mm) e placa metálica removível, para fácil gravação. A mala tem capacidade de 90 L e peso de 4,20 kg.

▮ 500 x 775 x 290 mm | Placa: 60 x 30 mm

➤ LSR – 50 x 22 mm



37 L

127

127

103



Placa para personalização



A

**Buenos Aires** — 92186

Mala de viagem executivo em ABS com interior forrado, com divisória. Fecho de segurança com senha na lateral, 4 rodas duplas giratórias, pega extensível em metal, com mola (altura pega estendida até 520 mm) e placa metálica removível, para fácil gravação. A mala tem capacidade até 37 L e peso de 2,50 kg.

☒ 355 x 555 x 225 mm | Placa: 29 x 29 mm

🔪 LSR – 25 x 10 mm



A

20 L

103



Placa para personalização

**Moura** — 92129

15,6"

Mala de viagem para notebook em c. sintético e 1680D com caixa rígida e 2 rodas. Compartimento interior forrado e almofadado para notebook portátil até 15,6". Etiqueta para identificação na parte posterior. Pega extensível em alumínio, com mola (altura da pega estendida até 675 mm) e placa metálica removível com imã, para fácil gravação. Mala com capacidade até 20 L e peso de 2,75 kg.

☒ 430 x 370 x 180 mm | Placa: 50 x 20 mm

🔪 LSR – 37 x 12 mm



123

**Kathrine** — 92125

Mala de cosméticos em 600D e EVA com fecho duplo. Compartimento frontal semi-rígido e interior forrado com 2 bolsos. A mala tem uma banda para transporte em trolley de viagem e alça ajustável em webbing.

☒ 305 x 250 x 85 mm

🔪 TRS – 150 x 100 mm

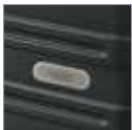

Placa para personalização



 **Phuket** — 92138

Mala de viagem executivo em ABS com interior forrado, com divisória. Fecho de segurança com senha na lateral, 4 rodas giratórias, pega extensível em alumínio, com mola (altura da pega estendida até 435 mm) e placa metálica removível, para fácil gravação. Mala com capacidade até 36 L e peso de 2,80 kg.

📏 370 x 570 x 220 mm | Placa: 60 x 15 mm

🔧 LSR - 48 x 9 mm

# Mochilas com trolley



Parte posterior e alças almofadadas



Pega extensível em metal



Base reforçada



## Eindhoven — 92145

Mochila trolley para notebook em 600D de alta densidade e poliéster 600D impermeável. Compartimento principal para notebook até 15.6". Bolso frontal com zíper e bolsos laterais com tela. Mochila trolley com protetor de rodas e pega extensível em metal. Parte posterior e alças almofadadas. Incluso placa metálica removível com imã, para fácil gravação.

340 x 430 x 170 mm

TR5 — 80 x 120 mm



15,6"



Placa para personalização



Protetor de rodas



Alças reforçadas e almofadadas



Protetor de rodas

## Note — 92283

Mochila trolley para notebook em 1680D e 300D com 2 rodas. Compartimento principal almofadado para notebook 15.6". Segundo compartimento forrado e com diversos bolsos. Bolso frontal com zíper e bolsos laterais com tela. O trolley tem protetor de rodas, alças almofadadas e pega extensível em metal, com mola (altura da pega estendida até 530 mm). Placa metálica removível com imã, para fácil gravação. Capacidade até 24 L e peso de 1,65 kg.

350 x 460 x 155 mm | Placa: 50 x 20 mm

LSR — 25 x 8 mm



15,6"

## Cardiff — 92183

Mochila trolley para notebook em 300D com 2 rodas duplas. Compartimento principal forrado e almofadado, com divisória para notebook até 15.6". A trolley tem 2 bolsos laterais em tela, protetor de rodas, alças almofadadas e pega extensível em alumínio, com mola (altura da pega estendida: 550 mm). Capacidade até 17 L e peso de 1,10 kg.

310 x 430 x 140 mm

TR5 — 130 x 140 mm



15,6"





Estrutura removível com pega extensível



Protetor de rodas



Alças reforçadas e almofadadas



Placa para personalização



**Miami** — 92293

Mochila trolley para notebook em Nylon 999 impermeável com 2 rodas. Compartimento principal almofadado para notebook até 17". Segundo compartimento forrado e com diversos bolsos. Bolso frontal com zíper e bolsos laterais com tela. O trolley tem protetor de rodas, estrutura removível, parte posterior e alças almofadadas e pega extensível em alumínio, com mola (altura da pega estendida até 550 mm). Placa metálica removível com imã, para fácil gravação. Capacidade até 30 L e peso de 1,70 kg.



350 x 460 x 225 mm | Placa: 50 x 20 mm

LSR – 37 x 12 mm



Placa para personalização



**Avenir** — 92177

Mochila trolley para notebook em 1680D e 300D com 2 rodas. Compartimento principal forrado e almofadado, com divisória almofadada para notebook até 17". 2 bolsos frontais e 2 bolsos laterais com zíper. O trolley tem protetor de rodas e alças almofadadas. Pega extensível em metal, com mola (altura da pega estendida: 550 mm). Placa metálica removível com imã, para fácil gravação. Capacidade até 22 L e peso 1,80 kg.

330 x 490 x 220 mm | Placa: 50 x 20 mm

LSR – 40 x 10 mm





NEW

### Repurpose Backpack — 92080



Mochila para notebook em rPET 600D com alças almofadadas. O compartimento principal tem 2 divisórias almofadadas para notebook até 15.6" e tablet até 10.5". Contém dois bolsos com fecho na parte frontal e um bolso lateral em rede com elástico. Parte posterior almofadada com banda para transporte em trolley.



300 x 420 x 110 mm  
TRS – 140 x 60 mm



### Repurpose Cooler — 98427

.310



NEW

### Repurpose Sports — 92079

Bolsa esportiva em rPET 600D com interior forrado e fundo com placa semi-rígida. Compartimento principal e bolso frontal com fecho e dois bolsos laterais, um em rede e outro com fecho. A bolsa tem alça de ombro removível e ajustável em webbing com reforço almofadado.

500 x 300 x 230 mm  
TRS – 280 x 50 mm



### Repurpose Bag — 92078

.205







## Repurpose Collection

A coleção que dá uma nova vida aos resíduos plásticos, transformando-os em produtos de qualidade e práticos.

A



C

B



Odin —  
94603  
♻️ .331





104

Material impermeável



Porta USB com cabo USB e micro USB



Placa para personalização



104

133

103



**Spacio** — 52675



Mochila para notebook em Nylon 2Tone impermeável com dois compartimentos forrados. O compartimento posterior tem bolso interior com zíper e divisória almofadada para notebook até 17". O compartimento frontal tem diversos bolsos interiores. Mochila com 2 bolsos frontais e 2 bolsos laterais com porta USB e cabo USB / micro USB para ligar a dispositivos móveis (bateria portátil não inclusa). Parte posterior almofadada, com sistema de apoio acolchoado para as costas e alças almofadadas. Placa metálica removível com imã, para fácil gravação.

310 x 470 x 200 mm |

Placa: 50 x 20 mm

LSR - 40 x 12 mm



133

Material impermeável



**Boston** — 92675



Mochila para notebook em Nylon 2Tone impermeável com 2 compartimentos. Compartimento posterior forrado, com bolso interior com zíper e divisória almofadada para notebook até 17". Compartimento frontal forrado, com diversos bolsos interiores. A mochila tem 2 bolsos frontais e 2 bolsos laterais. Porta USB e cabo USB / micro USB para ligar a dispositivos móveis (bateria portátil não inclusa). Parte posterior almofadada, com sistema de apoio acolchoado para as costas e alças almofadadas.

310 x 470 x 200 mm

TRS - 150 x 100 mm



NEW



### Brooklyn — 92081

Mochila para notebook em Nylon 2Tone impermeável com 2 compartimentos e alças almofadadas. O compartimento posterior tem 2 divisórias almofadadas com fecho em velcro para notebook até 17" e tablet até 10.5". Compartimento frontal com diversos bolsos interiores. Contém dois bolsos na parte frontal, tendo um deles bloqueio RFID. Nas laterais existe um bolso para garrafas em elastano e outro para o guarda chuva, com ilhós perfurados para evitar acumulação de água. A parte posterior almofadada tem um bolso oculto e uma banda para transporte em trolley.

320 x 450 x 140 mm

TR5 - 150 x 50 mm

17"

10.5"

123



Material impermeável



Placa para personalização

NEW



### Fortaleza — 52081

Mochila para notebook em Nylon 2Tone impermeável com 2 compartimentos e alças almofadadas. O compartimento posterior tem 2 divisórias almofadadas com fecho em velcro para notebook até 17" e tablet até 10.5". Compartimento frontal com diversos bolsos interiores. Contém dois bolsos na parte frontal, tendo um deles bloqueio RFID. Nas laterais existe um bolso para garrafas em elastano e outro para o guarda chuva, com ilhós perfurados para evitar acumulação de água. A parte de trás almofadada tem bolso oculto e banda para transporte em trolley. Placa metálica removível com imã, para fácil gravação.

320 x 450 x 140 mm

LSR - 35 x 15 mm

17"

10.5"

123



2 bolsos frontais



Alça para transporte em trolley



Bolso oculto nas costas com zipper



Entrada USB e Jack 3,5mm

2 bolsos laterais com zíper



NEW

17" **Lyon** — 92320

Mochila para notebook em 900D e Tarpaulin com 2 compartimentos principais com diversos bolsos interiores. Um completamente forrado e acolchoado para computador de grandes dimensões até 17". A mochila tem ainda 2 bolsos frontais, 2 bolsos laterais com zipper e bolso oculto nas costas com zipper. Contém ainda tira de transporte para trolley e entradas USB e Jack 3,5mm. Parte posterior e alças são almofadadas.

330 x 480 x 180 mm

TRS - 100 x 160 mm



2 bolsos frontais



Entrada USB e Jack 3,5mm

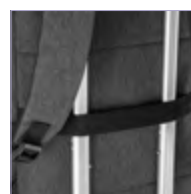

Alça para transporte em trolley



Bolso lateral

1 Bolso forrado para notebook



NEW

15,6" **Verona** — 92089

Mochila para notebook em 900D com um compartimento principal com bolso forrado para notebook 15,6" e diversos bolsos interiores. Contém ainda 2 bolsos frontais, 1 lateral e entrada USB. Parte posterior e alças são almofadadas.

310 x 440 x 110 mm

TRS - 140 x 160 mm





Alça para transporte em trolley

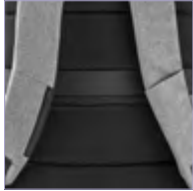

2 Bolsos nas alças, um com zipper



Bolso oculto nas costas com zipper



Entrada USB



Placa para personalização



123

133



Bolso no topo com zíper e bolso lateral



123

NEW

### MunIQUE — 92322

Mochila para notebook em 300D com placa de metal preta personalizável e 2 compartimentos principais. Os 2 bolsos almofadados são compatíveis com computador até 17" e com um tablet de 9,7". Tem ainda mais 2 bolsos nas alças (1 com zipper), bolso oculto nas costas da mochila com zipper, bolso no topo com zipper e bolso aberto na lateral com entrada USB. Contém ainda tira de transporte para trolley e alças e parte posterior almofadadas.

17"

9,7"

310 x 480 x 130 mm

TRS – 200 x 50 mm





15,6" **Zippers Plate** — 52280

Mochila para notebook em 840D jacquard com dois compartimentos forrados. O compartimento posterior tem duas divisórias almofadadas para notebook até 15.6" e tablet 10.5". O compartimento frontal tem diversos bolsos interiores. Mochila com 3 bolsos frontais e 2 bolsos laterais, parte posterior almofadada, com sistema de apoio acolchoado para as costas e alças almofadadas. Placa metálica removível com imã, para fácil gravação.

☒ 320 x 450 x 190 mm | Placa: 50 x 20 mm

☒ LSR – 40 x 12 mm

15,6" **Zippers Back** — 92280

Mochila para notebook em 840D jacquard e 300D com 2 compartimentos. Compartimento posterior forrado e almofadado, com 2 divisórias almofadadas para notebook até 15.6" e tablet 10.5". Compartimento frontal forrado, com diversos bolsos interiores. A mochila tem 3 bolsos frontais e 2 bolsos laterais. Parte posterior almofadada, com sistema de apoio acolchoado para as costas e alças almofadadas.

☒ 320 x 450 x 190 mm

☒ TRS – 140 x 25 mm



15,6" **Tupi** — 92167

Mochila para notebook em 1680D e 300D com dois compartimentos. Compartimento principal com divisória almofadada para notebook até 15.6". Interior forrado. Mochila com 3 bolsos frontais e 2 bolsos laterais, parte posterior almofadada, com sistema de apoio acolchoado para as costas e alças almofadadas. Placa metálica removível com imã, para fácil gravação.

☒ 330 x 480 x 180 mm | Placa: 50 x 20 mm

☒ LSR – 37 x 12 mm



**Zippers Sport** — 92516

Bolsa esportiva executivo em 840D jacquard e 300D e interior forrado. Contém bolsos frontais, fundo com placa semi-rígida e alça de ombro ajustável com reforço almofadado.

☒ 520 x 300 x 220 mm

☒ TRS – 140 x 50 mm



133

17" **Arky** — 92166

Mochila para notebook em 600D de alta densidade com compartimento forrado, com divisória almofadada para notebook até 17" e diversos bolsos interiores. 2 bolsos laterais em tela e 2 bolsos frontais. Parte posterior almofadada, com sistema de apoio acolchoado para as costas e alças almofadadas. Placa metálica removível com imã, para fácil gravação.

340 x 450 x 175 mm | Placa: 50 x 20 mm

LSR – 37 x 12 mm



103

NEW

15,6" **Angle Bpack** — 92270

Mochila para notebook em c.sintético. Compartimento com divisória almofadada para notebook até 15.6". Interior forrado e almofadado. Contém diversos bolsos interiores. A mochila tem 2 bolsos frontais e uma placa personalizável. A parte posterior é almofadada e tem sistema de apoio acolchoado para as costas e alças almofadadas.

340 x 450 x 130 mm | Placa: 40 x 20 mm

LSR – 30 x 15 mm

## Sistema anti-roubo

Zíper oculto para maior segurança



Zíper de acesso escondido



113

**Aveiro** — 92176

Mochila para notebook em 900D de alta densidade e tarpaulin. Sistema antirroubo: compartimento principal com zíper oculto e parte posterior com 2 bolsos ocultos com zíper, para maior segurança. Compartimento principal forrado e almofadado, com 2 divisórias almofadadas para notebook até 15.6" e tablet 10.5". Diversos bolsos interiores, incluindo bolso almofadado para smartphone. Presilhas para organização de cabos no interior. Bolso lateral exterior com zíper, com acesso a bolso interior ideal para bateria portátil, facilitando o carregamento de diversos dispositivos. Parte posterior almofadada e sistema de apoio acolchoado para as costas. Alças almofadadas, com 1 bolso com zíper.

320 x 440 x 200 mm

TRS – 150 x 200 mm

Bolso exterior lateral para fácil carregamento de equipamentos eletrônicos





**A**

**Traveller — 92674**

Mochila para notebook em 600D de alta densidade e tarpaulin com 2 compartimentos. Compartimento posterior forrado, com diversos bolsos interiores e 2 divisórias almofadadas para notebook até 17" e tablet 10.5". Compartimento frontal forrado, ideal para transporte de roupa (ou para lazer). A mochila tem bolso frontal e a parte posterior e alças são almofadadas.

17"

10.5"

300 x 430 x 150 mm

TR5 - 150 x 100 mm



**B**

**Adventure — 92174**

Mochila para computador em algodão canvas pré-lavado. Compartimento principal forrado, com 2 divisórias almofadadas para computador até 15.6" e tablet até 10.5". A mochila tem bolso frontal e 2 bolsos laterais. Parte posterior e alças são almofadadas. Contém alça para transporte em trolley e placa em c. sintético para personalização.

15.6"

10.5"

300 x 420 x 120 mm | Placa: 60 x 30 mm

TR5 - 45 x 15 mm





Entrada USB e Jack 3,5mm



Alça para transporte em trolley



Bolso lateral



2 bolsos forrados para notebook

C

Uplus  
Carriers



113

C

NEW

**Wellington** — 92087

15,6"

10,5"

Mochila para notebook em 300D com 1 compartimento principal com 2 bolsos forrados para computador 15,6" e tablet 10,5 e diversos bolsos interiores. Contém ainda bolso frontal, bolso lateral e entradas USB e Jack 3,5mm. Parte posterior e alças são almofadadas.

320 x 410 x 120 mm

TR3 - 180 x 180 mm



Placa para personalização



113

NEW

**Haia** — 52087

15,6"

10,5"

Mochila para notebook em 300D com placa de personalização. Tem 1 compartimento principal com 2 bolsos forrados para notebook até 15,6" e tablet 10,5" e diversos bolsos interiores. Contém ainda bolso frontal, lateral e entradas USB e Jack 3,5 mm. Parte posterior e alças são almofadadas.

320 x 410 x 120 mm

LSR - 35 x 15 mm



123



**14" Kardon** — 52627

Mochila para notebook até 14" em poliéster 600D. Compartimento principal forrado, com bolso interior e compartimento almofadado próprio para o computador. A mochila tem 2 bolsos frontais com fecho e a parte posterior é almofadada com sistema de apoio acolchoado para as costas e alças almofadadas. Placa metálica removível com imã, para fácil gravação.

☒ 305 x 445 x 130 mm

☒ LSR - 37 x 12 mm



103



**15" Rocco** — 92626

Mochila em 840D para notebook até 15". Contém 1 bolso principal com 3 bolsos adicionais e um bolso frontal com vários compartimentos e zíper. Na parte posterior da mochila tem um encaixe para trolley.

☒ 300 x 370 x 60 mm

☒ TRS - 150 x 150 mm



123



Placa para personalização

**15,6" Olympia Plate** — 52276

Mochila para notebook em 840D jacquard com dois compartimentos forrados. O compartimento posterior tem divisória almofadada para notebook até 15.6" e o compartimento frontal diversos bolsos interiores. Bolso lateral em tela e bolso frontal. Parte posterior almofadada, com sistema de apoio acolchoado para as costas e alças almofadadas. Placa metálica removível com imã, para fácil gravação.

☒ 305 x 470 x 180 mm | Placa: 50 x 20 mm

☒ LSR - 37 x 12 mm



123

**15,6" Olympia** — 92276

Mochila para notebook em 840D jacquard com dois compartimentos. Compartimento posterior forrado, com divisória almofadada para notebook até 15.6". Compartimento frontal forrado, com diversos bolsos interiores. Bolso lateral em tela e bolso frontal. Parte posterior almofadada, com sistema de apoio acolchoado para as costas e alças almofadadas.

☒ 305 x 470 x 180 mm

☒ TRS - 130 x 50 mm





17" **Zagazig** — 92677

Mochila para notebook em 900D e c. sintético com 2 compartimentos. Compartimento posterior forrado, com divisória almofadada para notebook até 17" e bolso em tela, com zíper. Compartimento frontal forrado, com diversos bolsos interiores. Parte posterior e alças almofadadas.

330 x 450 x 160 mm

TR5 – 130 x 150 mm



15,6" **Derby** — 92523

Mochila para notebook em 900D e c. sintético com 2 compartimentos principais e bolso frontal. O compartimento posterior é forrado e tem divisória almofadada para notebook até 15,6" e bolso em tela, com zíper. O compartimento médio também é forrado e contém diversos bolsos interiores. A parte posterior e alças são almofadadas.

330 x 450 x 160 mm

TR5 – 50 x 160 mm

Material impermeável



**Bangkok** — 92636



Mochila para notebook em 600D de alta densidade e poliéster 600D impermeável. Compartimento principal almofadado para notebook até 15.6". Bolso frontal com zíper e dois bolsos laterais em tela. Parte posterior almofadada, com sistema de apoio acolchoado para as costas e alças almofadadas.

280 x 400 x 110 mm

TRS - 120 x 180 mm



**Lunar** — 92164

Mochila para notebook em 600D de alta densidade. Compartimento com 2 divisórias almofadadas para notebook até 15.6" e tablet 9.7". Interior forrado e almofadado. Mochila com 1 bolso frontal e 2 bolsos laterais. Parte posterior almofadada, com sistema de apoio acolchoado para as costas e alças almofadadas.

290 x 390 x 155 mm

TRS - 100 x 130 mm



Placa para personalização

**Manaus** — 92163

Mochila para notebook em 1680D e 300D com dois compartimentos para notebook 14" e para tablet 9.7". Interior forrado e almofadado. Bolso frontal com zíper, bolso lateral e placa metálica removível com imã, para fácil gravação.

310 x 400 x 110 mm | Placa: 50 x 20 mm

LSR - 37 x 12 mm



103



Placa para personalização



### Birmingham — 52637



Mochila para notebook em poliéster 600D impermeável com compartimento principal almofadado para notebook até 15.6". Bolso frontal e zípers impermeáveis. Bolso lateral em tela e parte posterior almofadada, com sistema de apoio acolchoado para as costas e alças almofadadas. Placa metálica removível com imã, para fácil gravação.

▮ 280 x 400 x 110 mm

▮ LSR - 40 x 12 mm



114

105

123



### Osasco — 92637



Mochila para notebook em poliéster 600D impermeável e zípers impermeáveis. Compartimento principal almofadado para computador até 15.6". Contém um bolso lateral e um bolso frontal. Parte posterior almofadada, com sistema de apoio acolchoado para as costas e alças almofadadas.

▮ 245 x 400 x 115 mm

▮ TRS - 120 x 150 mm



• Material e zíper impermeáveis



• Material e zíper impermeáveis



123

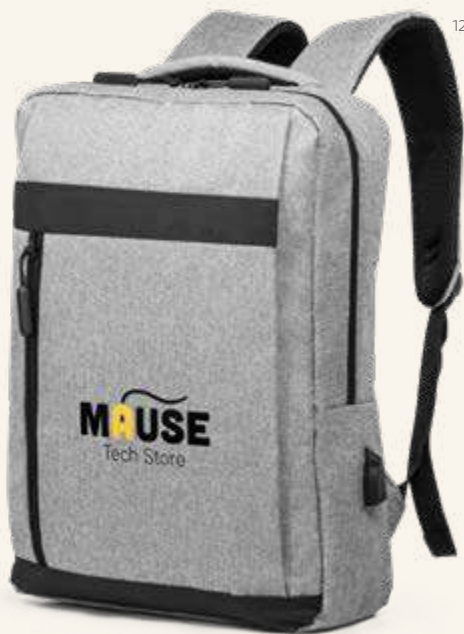

Entrada USB



2 bolsos frontais



Bolso lateral

NEW

**Denver** — 92321

15,6"

Mochila para notebook em 300D melange. Inclui 1 compartimento principal com bolso interior forrado compatível com computador até 15,6" e diversos bolsos multifuncionais. A mochila tem 2 bolsos frontais, 1 lateral e entrada USB. A parte posterior e alças são almofadadas.

± 300 x 410 x 110 mm

TRS - 120 x 120 mm

105



105



114



103



114



114



103



15,6"

**Viena** — 92179

Mochila para notebook em 600D de alta densidade. Compartimento principal com divisória almofadada para notebook até 15,6". Bolso frontal com zíper. Parte posterior e alças almofadadas.

± 290 x 370 x 110 mm

TRS - 140 x 100 mm



15,6"

**Bremen** — 92182

Mochila para notebook em 600D de alta densidade. Compartimento principal com divisória almofadada para notebook até 15,6". Bolso frontal com zíper. Parte posterior e alças almofadadas.

± 290 x 370 x 110 mm

TRS - 140 x 100 mm





Entrada USB



Bolso lateral



B



104



113



133



104



113



133



104



113

A

NEW

15,6"

**Creta** — 92085

Mochila para notebook em 300D com 1 compartimento principal com bolso forrado para computador até 15,6" e diversos bolsos interiores. Contém ainda bolso frontal, bolso lateral e entrada USB. Parte posterior e alças são almofadadas.

300 x 420 x 120 mm

TR5 - 150 x 150 mm

B

NEW

15,6"

**Boracay** — 52085

Mochila para notebook em 300D com placa de personalização. Tem 1 compartimento principal com bolso forrado para notebook até 15,6" e diversos bolsos interiores. Contém ainda bolso frontal, lateral e entrada USB. Parte posterior e alças são almofadadas.

300 x 420 x 120 mm

LSR - 35 x 15 mm



Placa para personalização

**15,6"** **Graphs Plate** — 52668

Mochila para notebook em 600D de alta densidade com compartimento com divisória almofadada para notebook até 15.6". Interior forrado e almofadado. Mochila com 2 bolsos frontais, parte posterior e alças almofadadas. Placa metálica removível com imã, para fácil gravação.

☒ 295 x 390 x 100 mm | Placa: 50 x 20 mm

🔪 LSR - 40 x 12 mm



**15,6"** **Graphs Bpack** — 92668

Mochila para notebook em 600D de alta densidade. Compartimento com divisória almofadada para computador até 15.6". Interior forrado e almofadado. A mochila tem 2 bolsos frontais com parte posterior e alças almofadadas.

☒ 295 x 390 x 100 mm

🔪 TRS - 180 x 140 mm



**14"** **Graphs Laptop** — 92286

Pasta para notebook em 600D de alta densidade. Compartimento forrado e almofadado, com divisória para notebook até 14". A pasta tem um bolso frontal, alça de ombro ajustável, com reforço almofadado e banda para transporte em trolley.

☒ 370 x 280 x 50 mm

🔪 TRS - 250 x 150 mm



**15,6"** **Santana** — 92266

Pasta para notebook em 600D 2Tone e 300D com compartimento forrado e divisória almofadada para notebook até 15.6". A pasta tem bolso frontal com diversos compartimentos interiores. No verso contém uma banda para transporte em trolley. Alça de ombro ajustável com reforço almofadado.

☒ 400 x 295 x 75 mm

🔪 TRS - 250 x 120 mm





**Shades Bpack** — 92170

Mochila para notebook em 600D de alta densidade. Compartimento principal forrado, com 2 divisórias almofadadas para computador até 14" e tablet até 9.7". A mochila tem 1 bolso frontal e 1 bolso lateral. Parte posterior e alças almofadadas.

310 x 400 x 110 mm  
 TRS – 100 x 140 mm



**Shades Plate** — 52170

Mochila para notebook em 600D de alta densidade. Compartimento forrado, com duas divisórias almofadadas para notebook até 14" e tablet 9.7". Com um bolso frontal e lateral, parte posterior e alças almofadadas e placa metálica removível com imã, para fácil gravação.

310 x 400 x 110 mm | Placa: 50 x 20 mm  
 LSR – 40 x 12 mm



Placa para personalização



**Shades Cross** — 92173

Pasta à tiracolo em 600D de alta densidade. Compartimento principal forrado, divisória almofadada para tablet 9.7" e com diversos bolsos interiores. A pasta tem ainda bolso frontal e bolso posterior, alça de ombro ajustável e parte posterior almofadada.

220 x 270 x 45 mm  
 TRS – 100 x 140 mm



**Wiltz** — 92168

Mochila para notebook em 600D de alta densidade com 2 compartimentos forrados. Compartimento posterior com diversos bolsos interiores e 2 divisórias almofadadas para notebook até 15.6" e tablet 10.5".

Compartimento frontal ideal para transporte de roupa (ou para lazer). Parte posterior e alças almofadadas. Alça para transporte em trolley.

300 x 450 x 160 mm  
 TRS – 200 x 100 mm



**14"** Kiev — 92622

Mochila para notebook em 600D de alta densidade. Compartimento principal com divisória almofadada para notebook até 14". Bolso frontal com zíper. Parte posterior e alças almofadadas.

☒ 290 x 400 x 140 mm

☒ TRS – 180 x 120 mm



**15,6"** Brussels — 92169

Mochila para notebook em 600D. Contém bolso frontal com fecho e bolso lateral em tela. Compartimento com divisória para computador até 15.6". Interior forrado e almofadado com bolsos interiores. Alça de ombro ajustável e com reforço.

☒ 290 x 430 x 100 mm

☒ TRS – 180 x 120 mm



**15,6"** Hexa — 92288

Mochila para notebook em 600D. Compartimento com divisória almofadada para notebook até 15.6". Bolso lateral em tela e bolso frontal. Parte posterior e alças almofadadas. Bateria e fone não inclusos.

☒ 310 x 450 x 120 mm

☒ TRS – 150 x 150 mm



**Hexa Sport** — 92515

Bolsa esportiva em 600D. Fundo com placa semi-rígida, bolso frontal com zíper e bolso em tela. Alça de ombro ajustável, com reforço. Squeeze não incluso.

☒ 460 x 290 x 220 mm

☒ TRS – 200 x 80 mm

# Mais divisórias, mais arrumação para levar tudo o que precisa



A



## April — 92545

Pochete em 600D de alta densidade. Compartimento principal e um zíper na parte posterior. A bolsa tem alça ajustável em webbing.

▮ 220 x 120 mm

▮ TRS - 120 x 45 mm



113

113

104

A



## Muzeul — 92544

Bolsa de cintura em 300D de alta densidade. Compartimento principal com fecho e bolso interior em rede elástica e bolso na parte posterior de fácil acesso, ideal para guardar os bens com maior segurança. A parte frontal contém um bolso em rede elástica, um bolso com pala, botão para fecho e um elástico na lateral, indicado para pendurar mosquetões ou óculos de sol. A alça é ajustável em webbing com fecho.

▮ 270 x 120 x 65 mm

▮ TRS - 100 x 35 mm





Com apito

Reservatório de água com capacidade até **2L**



Yates —  
92799  
0.364

Elementos refletivos



113

 **Mounti** — 92628

Mochila desportiva em 420D com compartimento principal forrado e bolso frontal com zíper. Painel frontal com elementos refletivos. A parte posterior da mala e as alças são almofadadas para garantir um maior conforto para as costas. Ainda na parte posterior contém alça com fecho, para garantir que a mala é ajustada ao tronco, facilitando o seu transporte em movimento e uso prolongado. A mochila inclui um reservatório de água com capacidade até 2 L e canudo. A mochila e o reservatório são fornecidos separadamente.

▮ 265 x 410 x 55 mm

▮ TRS - 100 x 100 mm



103

**Giraldo** — 92520

Bolsa esportiva em poliéster 300D com alça de ombro ajustável, fundo com placa rígida, 1 bolso principal e 4 bolsos adicionais.

☒ 640 x 370 x 310 mm

☞ TRS – 230 x 170 mm



113



104

**Bago** — 92517

Bolsa esportiva em 300D e 1680D. Fundo com placa semi-rígida. Contém um bolso frontal com zíper, um bolso lateral em tela e um bolso lateral para sapatos. Alça de ombro ajustável, com reforço almofadado.

☒ 570 x 330 x 300 mm

☞ TRS – 200 x 100 mm



128



103



104



124



119

**Fit** — 92511

Bolsa esportiva em 600D com divisória interior e fundo com placa semi-rígida. Bolso frontal e bolso lateral para calçado, ambos com zíper. Alça de ombro ajustável.

☒ 520 x 300 x 255 mm

☞ TRS – 200 x 90 mm



105

# Mochilas com cores para todos os gostos



**Jaipur** —  
98408  
📄 .313



109



105



104



109 124 104 105

128 108 119 103



105 128 119

104 124 131 103



104 113

## **Turim** — 92471

Mochila em 600D com bolsos laterais em tela e bolso interior. Parte posterior e alças almofadadas.

☒ 250 x 420 x 180 mm

🔪 TRS - 90 x 70 mm

## **Berna** — 92667

Mochila em 600D com bolso frontal com fecho. Parte posterior e alças almofadadas.

☒ 310 x 410 x 120 mm

🔪 TRS - 130 x 80 mm

## **City** — 92665

Mochila em 600D com saída para fone de ouvido. Interior forrado, com bolso e 2 bolsos laterais em rede. Parte posterior e alças almofadadas.

☒ 270 x 400 x 140 mm

🔪 TRS - 120 x 95 mm





## Juco: o novo tecido ecológico

A combinação entre o algodão e a juta resulta num material de alta durabilidade e resistência: o Juco. Um tecido sustentável, versátil e cada vez mais presente no nosso dia a dia.



**Padova** —  
92937

 .291

**NEW**



**Marbella** — 92938

Mochila em juco (275 g/m<sup>2</sup>) com um compartimento principal e bolso frontal com fecho. Pega em webbing de algodão no topo e alças ajustáveis em algodão bicolor.

📏 270 x 350 x 70 mm

🔪 TRS - 150 x 180 mm



160



114



Alças reflexivas nas laterais

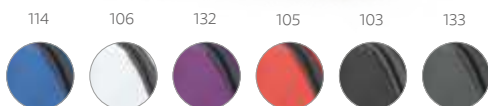

**Gauteng** — 92638

Mochila dobrável em 210D ripstop com bolso frontal e dois bolsos laterais em tela.

∓ 330 x 400 x 120 mm | Dobrada: 195 x 160 x 25 mm

➤ TRS - 120 x 100 mm



109



**Barcelona** — 92669

Mochila dobrável em 210D ripstop com bolso frontal. Fornecida desdobrada.

∓ 295 x 415 x 110 mm | Dobrada: 160 x 130 mm

➤ TRS - 160 x 70 mm



133



**Carnaby**  
92910

∓ .307



**Toronto** — 92568

Sacola esportiva dobrável em 210D ripstop com bolso frontal. Fornecida desdobrada.

∓ Ø240 x 410 mm | Dobrado: 160 x 160 mm

➤ TRS - 100 x 80 mm



114

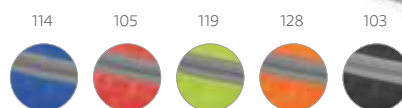

**Munich** — 92569

Pochete em 210D ripstop com saída para fone de ouvido. Bolsa com zíper e alça ajustável.

∓ 250 x 80 mm

➤ TRS - 200 x 20 mm





# Leves e práticas

Acompanham-no para qualquer lugar.



104



103

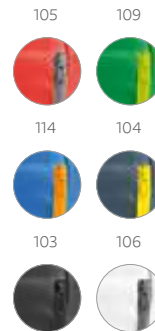

A



105

## Logan — 52635

Mochila em 600D com bolso exterior frontal com zíper. Parte posterior almofadada, com sistema de apoio acolchoado para as costas e alças almofadadas.

▮ 245 x 400 x 115 mm

▮ TRS - 100 x 120 mm

## Bertle — 92635

Mochila em 600D com bolso exterior frontal com zíper. Parte posterior almofadada, com sistema de apoio acolchoado para as costas e alças almofadadas.

▮ 245 x 400 x 115 mm

▮ TRS - 90 x 60 mm





**Tangram** — 92291

Pasta multifunções em 600D. Contém 2 bolsos frontais com zíper e alça de ombro ajustável com reforço.

▮ 380 x 300 x 80 mm  
 ✂ TRS – 150 x 140 mm



**Seoul** — 92257

Pasta multifunções em 600D. Compartimento exterior aberto (forrado) com bolso frontal com zíper. A pasta tem alça de ombro ajustável e alças de mão com reforço.

▮ 400 x 300 x 100 mm  
 ✂ TRS – 200 x 120 mm



**Frankfurt** — 92156

Pasta de congresso em 600D com interior forrado.

▮ 380 x 280 x 50 mm  
 ✂ TRS – 280 x 70 mm



**Doha** — 92236

Pasta de congresso em 600D com zíper, ideal para transportar documentos.

▮ 390 x 290 x 80 mm  
 ✂ TRS – 280 x 120 mm



160



**ecologic**



**Nisa** — 92274



Pasta para notebook em cortiça. Compartimento forrado e almofadado, com divisória para notebook até 15.6". A pasta tem um bolso frontal e alça de ombro ajustável, com reforço almofadado. Fornecida em embalagem de non-woven.

410 x 310 x 75 mm | Sacola: 490 x 378 mm

TR5 - 40 x 18 mm



123

Suporte para esferográficas

**Chicago** — 92258

15,6"

Pasta para notebook até 15.6" em 600D com interior forrado e almofadado. Tem 2 bolsos frontais e alça de ombro ajustável. A pasta tem suporte para esferográficas (não inclusas).

400 x 300 x 80 mm

TR5 - 150 x 150 mm



104

104

103

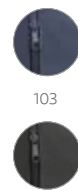

**Garbi** — 92197

14"

Pasta para notebook até 14" em poliéster 600D com alça de ombro ajustável e reforçada, 1 bolso principal e 2 bolsos adicionais. Interior forrado e almofadado.

370 x 290 x 60 mm

TR5 - 200 x 150 mm



**Milo** — 92316

Pasta congresso em 600D com 1 bolso principal e zíper. Indicada para transportar documentos.

☒ 390 x 300 x 40 mm

✂️ TXP – 260 x 150 mm



**Kayl** — 92357

Pasta de congresso em non-woven (80 g/m<sup>2</sup>) com 1 compartimento com zíper. Ideal para transportar documentos.

☒ 380 x 300 mm

✂️ TXP – 260 x 150 mm





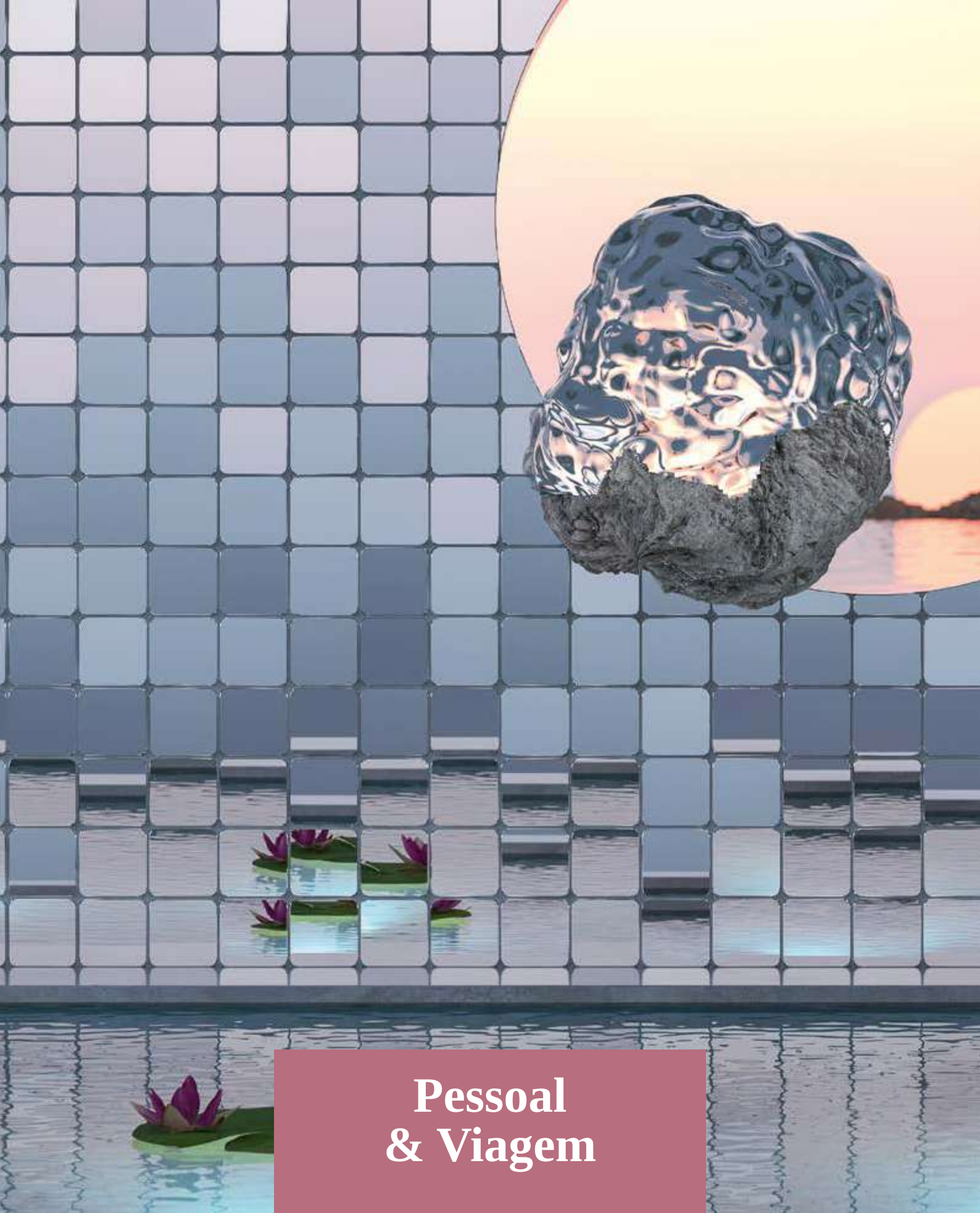

**Pessoal  
& Viagem**





# Repurpose Collection



**Repurpose Backpack** — 92080

📏 .174



**Repurpose Sports** — 92079

📏 .174



**Repurpose Cooler** — 98427

📏 .315



## PET Reciclado

O rPET é muito mais do que plástico reciclado. As suas aplicabilidades são muitas e podem estar presente em vários objetos do dia a dia.



Interior forrado



113



104



NEW

ecologic



**Repurpose Bag** — 92078

Nécessaire em rPET 600D com interior forrado. Bolso frontal com zíper e pega lateral em webbing.

📏 220 x 120 x 110 mm

🔪 TRS - 140 x 35 mm





## Algodão e cortiça: a união perfeita

Materiais extremamente versáteis e resistentes, tornando qualquer objeto mais forte e sustentável.



**ecologic**

**Blanchett** — 92735

Bolsa de cosméticos 100% algodão (280 g/m<sup>2</sup>) com detalhes em cortiça no fundo da bolsa e puxador do fecho, que também tem a função de pega para facilitar o transporte. O interior é forrado, sendo de fácil limpeza e rápida secagem, ideal para guardar maquiagem.

220 x 130 x 80 mm

TR5 - 95 x 60 mm



## Algodão reciclado

Proveniente do excedente da produção têxtil, este tipo de algodão torna o processo mais sustentável.

160

160



104



103



NEW

EcoLogic



**Millie** — 92077

Bolsa multifunções com algodão reciclado (140 g/m<sup>2</sup>) e zíper.

☒ 225 x 120 mm

☒ TRS - 180 x 80 mm





144



**Eliza** — 92731

Bolsa de cosméticos em 300D de alta densidade com pega almofadada, interior forrado e bolso interior com zíper.

☒ 200 x 115 x 140 mm

✂ TRS – 140 x 60 mm



131

● Fecho de dois sentidos



**Crowe** — 92715

Bolsa de cosméticos em microfibra com detalhe em c. sintético e zíper duplo.

☒ 180 x 120 x 100 mm

✂ TRS – 30 x 15 mm



105



**Kevin** — 92728

Bolsa de cosméticos em 300D de alta densidade com pega, bolso frontal, interior forrado e zíper.

☒ 220 x 115 x 115 mm

✂ TRS – 150 x 50 mm



113



**Wayne** — 92732

Bolsa de cosméticos em 600D de alta densidade com pega e interior forrado.

☒ 220 x 110 x 110 mm

✂ TRS – 140 x 60 mm





Vários bolsos interiores e gancho no topo

A



116



133



104



105



116

A

### Milli — 92148

Bolsa de cosméticos em 600D de alta densidade. O compartimento principal tem zíper duplo e revestimento interior em 210D. Contém vários bolsos interiores e gancho no topo para pendurar.

☒ 250 x 180 x 105 mm

☒ TRS - 100 x 110 mm



103



103



104



105

### Cotia — 92723

Bolsa de cosméticos com pega e bolso frontal em 300D.

☒ 240 x 160 x 55 mm

☒ TRS - 150 x 60 mm



104



104



131



103



### Willis — 92724

Bolsa de cosméticos em microfibra com vários bolsos interiores e gancho de pendurar.

☒ 200 x 160 x 85 mm

☒ TRS - 120 x 60 mm

Cores metálicas



112



**Loren** — 92713

Bolsa multiusos em PVC com zíper, disponível em cores metalizadas. Prática e compacta ideal para uso diário ou em viagem.

☒ 140 x 95 x 70 mm

✂ SCR – 100 x 60 mm



104



**Bree** — 92852

Bolsa multiusos em non-woven (80 g/m<sup>2</sup>) e termo-selada.

☒ 300 x 270 x 120 mm

✂ TXP – 140 x 140 mm



119



105



**Weida** — 92719

Bolsa de cosméticos em 600D com pega e bolso frontal.

☒ 200 x 115 x 85 mm

✂ TRS – 140 x 60 mm



**Eastwood** — 92730

Bolsa de cosméticos em 600D com pega e interior forrado.

☒ 220 x 120 x 120 mm

✂ TRS – 140 x 60 mm



A



108



A

**Marie** — 92721

Bolsa multiusos em microfibra com zíper.

∓ 130 x 90 x 65 mm

↗ TRS - 80 x 30 mm



105



105

108

114

112

131

103

**Annie** — 92717

Bolsa de cosméticos em microfibra e rede com zíper.

∓ 210 x 130 x 85 mm

↗ TRS - 90 x 90 mm



114



114

131

102

**Anjelica** — 92716

Bolsa de cosméticos em microfibra e tela.

∓ Ø155 x 145 mm

↗ TRS - 90 x 20 mm





**A**

**Deniro** — 92722

Bolsa de cosméticos hermética em PVC. Incluso 3 frascos (2 x 65 ml e 60 ml), 1 vaporizador (80 ml) e 1 funil. Apropriada para transporte em cabine de avião.

☒ 190 x 155 x 40 mm

✂ SCR – 120 x 100 mm

**B**

**Valentina** — 92720

Bolsa de cosméticos hermética em PVC. Apropriada para transporte em cabine de avião. Frascos não inclusos.

☒ 165 x 185 x 40 mm |

Capacidade < 1 Litro

✂ SCR – 110 x 110 mm

105

**Ingrid I** — 92733

Bolsa hermética em EVA com fecho.  
Apropriado para viagem de avião.

☒ 200 x 125 mm

✂ SCR - 120 x 45 mm

102

**Chastain** — 92737

Bolsa de cosméticos em EVA com fecho de correr e puxador metálico. Apropriado para viagem de avião.

☒ 200 x 145 x 70 mm

✂ SCR - 100 x 50 mm

103



106

**Ingrid II** — 92734

Bolsa hermética em EVA com fecho.  
Apropriado para viagem de avião.

☒ 150 x 160 mm

✂ SCR - 100 x 80 mm

104

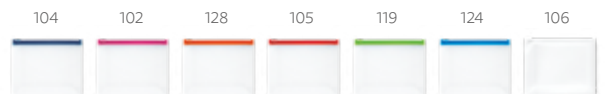
**Margot** — 92741

Bolsa hermética em EVA com fecho de correr.  
Apropriado para viagem de avião.

☒ 190 x 150 x 50 mm

✂ SCR - 100 x 50 mm

Temporizador  
de **5 minutos**



106

**Elora** — 94300

Ampulheta de banho em ABS com ventosa que permite a rotação do produto quando colocado na parede. Incluso temporizador de 5 minutos.

☒ 100 x 128 x 35 mm

🔪 SCR – 20 x 50 mm



112



112

106

103

**Euna** — 94852

Kit de 4 lixas. Composto por: 2 lixas abrasivas e 2 lixas polidoras.

☒ 22 x 65 x 17 mm

🔪 PDP – 15 x 35 mm



112



112

106

103

**Aniston** — 94856

Conjunto de 6 lixas para unhas fornecido em caixa de cartão personalizável.

☒ 55 x 61 x 6 mm

🔪 PDP – 40 x 30 mm



112



102



103



110



127



112

104

106

103



**Nadia** — 94843

Conjunto de 4 peças para manicure: cortador de unhas, tesoura, pinça e empurra cutículas. Fornecido em estojo.

☒ 100 x 53 x 20 mm

🔪 PDP – Ø20 mm

**Lopez** — 94857

Conjunto de 4 peças para manicure em bolsa de PVC. Composto por lixa, pinça, corta unhas e empurra cutículas.

☒ 66 x 105 mm

🔪 PDP – 40 x 30 mm

**Gavis** — 94835

Espelho de maquiagem duplo.

☒ 68 x 64 x 11 mm

🔪 PDP – 50 x 25 mm



# Conjuge a sua Higiene com produtos ECologic



B

A



A

NEW **ECologic**



**Zena** — 94897

Conjunto de manicure em cortiça com cinco peças em aço inoxidável: lixa, tesoura, cortador de unhas, pinça e empurra cutículas. Fornecido em bolsa de papel natural.

∓ 104 x 61 x 17 mm  
 ↗ LSR - 40 x 30 mm

160



119

105



**Streep** — 94853

Espelho de maquiagem com formato redondo, prático e com o tamanho ideal para transportar na bolsa.

∓ Ø60 x 5 mm  
 ↗ DUV - 47 x 47 mm



160

B

NEW **ECologic**



**Tilbury** — 94898

Espelho de bolsa duplo em cortiça com fecho magnético. Fornecido em bolsa de papel natural.

∓ Ø73 x 20 mm  
 ↗ LSR - Ø40 mm

# Estar bem com você mesmo!

A organização é fundamental para uma sensação de conforto e bem-estar. Mantenha por perto tudo o que precisa e sinta-se mais tranquilo.



**Roberts** — 94306  
 Porta comprimidos com 4 divisórias com tampa, disponível em várias cores. Food grade.  
 60 x 60 x 18 mm  
 PDP – 20 x 20 mm



Cortador de comprimidos



**Nero** — 94307  
 Porta comprimidos com tampa, 2 divisórias e cortante. As divisórias são extraíveis e coloridas, facilitando a sua distinção. Food grade.  
 94 x 48 x 16 mm  
 PDP – 50 x 30 mm



**Stiller** — 94301  
 Caixa de comprimidos com 3 divisórias.  
 60 x 35 x 13 mm  
 PDP – 40 x 25 mm



7 divisórias para cada dia da semana



**Jimmy** — 94305  
 Porta comprimidos com tampa e 7 divisórias, ideal para separar pelos dias da semana. Food grade.  
 85 x 55 x 20 mm  
 PDP – 55 x 32 mm





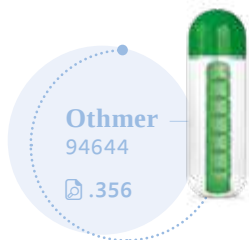

**Othmer**  
94644

📄 .356

Copo de viagem  
com caixa para  
comprimidos



150

**ecologic**



**Nadal** — 94769

Copo de viagem retrátil  
em fibra de bambu (50%) e PP (50%)  
com capacidade até 210 ml. Incluso caixa  
para comprimidos e mosquetão.

📏 Ø65 x 33 mm

🔪 PDP - Ø35 mm





Frasco  
recarregável  
e reutilizável

### Reflask 500 — 94913

Frasco com doseador em PET e PP, com capacidade até 500 ml. Frasco recarregável e reutilizável.

∅ 85 x 150 mm

DUV - 30 x 40 mm



### Lyze II — 92725

Frasco PETG de 50 ml com tampa flip top e mosquetão. Indicado para colocar álcool gel.

∅ 45 x 120 mm

STI - 30 x 50 mm



### Healty 5L — 94895

Álcool em Gel Galão 5 Litros 70% antisséptico para higienização a seco das mãos e superfícies. Combate 99,9% dos germes e bactérias e hidrata a pele com solução protetora da pele, diminuindo o impacto do ressecamento provocado pelo álcool. Embalagem transparente em PP. Ideal para desinfetar ambientes profissionais. Instruções de uso: Aplicar o produto diretamente no local a ser higienizado, espalhar e deixar secar, sem enxágue. Não utilizar em superfícies sensíveis ao álcool. Armazenamento: Manter o produto em local arejado, longe do calor e do fogo. Dermatologicamente testado e certificado pela ANVISA. Disponível personalização do frasco com logomarca.

∅ 280 x 190 x 140

SCR - 110 x 95 mm



### Healty 500 — 94894

Álcool em Gel 500ml 70% antisséptico para higienização a seco das mãos e braços. Combate 99,9% dos germes e bactérias e hidrata a pele com solução protetora da pele, diminuindo o impacto do ressecamento provocado pelo álcool. Embalagem transparente em PP. Ideal para ter no escritório ou em casa. Instruções de uso: Aplicar uma pequena quantidade de Álcool Gel na palma da mão e espalhar até total absorção, sem enxágue. É recomendada a sua utilização para completar a limpeza rotineira das mãos. Dermatologicamente testado e certificado pela ANVISA. Disponível personalização do frasco com logomarca.

∅ 70 x 200 mm

PDP - 45 x 65 mm



### Healty 100 — 94893

Álcool em Gel 100ml 70% antisséptico para higienização a seco das mãos e braços. Combate 99,9% dos germes e bactérias e hidrata a pele com solução protetora da pele, diminuindo o impacto do ressecamento provocado pelo álcool. Embalagem transparente em PP. Ideal para levar sempre na bolsa ou mochila e usar em qualquer lugar. Instruções de uso: Aplicar uma pequena quantidade de Álcool Gel na palma da mão e espalhar até total absorção, sem enxágue. É recomendada a sua utilização para completar a limpeza rotineira das mãos. Dermatologicamente testado e certificado pela ANVISA. Disponível personalização do frasco com logomarca.

∅ 36 x 125 mm

PDP - 25 x 60 mm



### Healty 60 — 94892

Álcool em Gel 60ml 70% antisséptico para higienização a seco das mãos e braços. Combate 99,9% dos germes e bactérias e hidrata a pele com solução protetora da pele, diminuindo o impacto do ressecamento provocado pelo álcool. Embalagem transparente em PP. Ideal para levar sempre na bolsa ou mochila e usar em qualquer lugar. Instruções de uso: Aplicar uma pequena quantidade de Álcool Gel na palma da mão e espalhar até total absorção, sem enxágue. É recomendada a sua utilização para completar a limpeza rotineira das mãos. Dermatologicamente testado e certificado pela ANVISA. Disponível personalização do frasco com logomarca.

∅ 38 x 90 mm

PDP - 25 x 45 mm



## Proteja-se! Mais prevenção, maior segurança

### LED Whidy — 94953

Dispenser automático de sabão ou desinfetante em ABS e PP com sensor infravermelho de movimento com LED branco no interior do recipiente e capacidade de 330 ml (sabão ou desinfetante não incluídos). Incluso 4 pilhas AAA. Fornecido em caixa.

123 x 195 x 83 mm

PDP - 15 x 15 mm

330 ml

106



1m

### LED Germout — 58519

Caixa esterilizadora em ABS e PC com combinação entre radiação UVC e UVA que permite a eliminação de um número significativo de bactérias. A caixa possui 2 leds UV no interior com uma potência total de 2W, e foi especialmente desenhada para a eliminação de bactérias em objetos de uso diário, como: chaves, celulares, smartphones, máscaras, óculos, comandos, jóias, e outros pequenos utensílios. Eficiência de 70% com apenas 1 ciclo de 5 minutos, e 99,9% com dois ciclos de 5 minutos. Possui um sensor de segurança que desliga de imediato as lâmpadas assim que é aberta a caixa. A parte superior da caixa Incluso um carregador wireless de carregamento rápido (10W), com entrada de 5V/3A e porta de carregamento USB tipo C. Incluso cabo de 1 metro. Fornecida em caixa presente.

210 x 120 x 55 mm | Interior: 190 x 95 x 20 mm | Caixa: 240 x 130 x 71 mm

SCR - 150 x 70 mm

Carregador wireless  
de carregamento  
rápido



106





Em alumínio



**A**

**NEW**

**Emil** — 98111

Identificador de bagagem em alumínio com cordão. Ideal para malas de viagem.

▮ 80 x 42 x 2 mm

▮ LSR – 60 x 15 mm



105



105



124



106



103

**Findo** — 98124

Identificador de bagagem em PP. Ideal para malas de viagem.

▮ 87 x 50 x 4 mm

▮ PDP – 50 x 20 mm





## Desfrute e viaje relaxado



### Travelx — 98197

Kit de viagem composto por almofada de pescoço, máscara para dormir, tampões para ouvidos (não é um equipamento de proteção individual) e 1 par de meias. Fornecido com bolsa em 190T.

☒ Bolsa: 150 x 200 mm

☑ TRS - 100 x 100 mm



### Dozy — 98113

Máscara para dormir em 190T com interior almofadado.

☒ 185 x 90 mm

☑ TRS - 100 x 35 mm



### Strada — 98180

Almofada de pescoço inflável em PVC aveludado. Fornecida em bolsa.

☒ Vazio: 425 x 275 mm | Bolsa: 175 x 115 mm

☑ TRS - 100 x 25 mm



127



**Cobb** — 98117

Kit de limpeza de sapatos com 6 peças:  
1 cera incolor para sapatos, 1 flanela  
amarela, 2 escovas em madeira,  
1 calçadeira e 1 embalagem lata.

∓ Ø98 x 56 mm

↗ LSR – Ø65 mm



106



106

102

**Bilbo** — 94879

Kit de costura prático e leve para levar em viagem.  
Composto por 3 alfinetes, 3 agulhas, 1 pinça, 1 tesoura,  
1 enfia linha, 1 alfinete, 2 botões, 2 colchetes e 6 rolos  
de linhas de várias cores. Fornecido em estojo.

∓ 70 x 21 x 65 mm

↗ DUV – 60 x 45 mm



103

**Gwenno** — 92851

Bolsa para sapatos em non-woven  
(80 g/m<sup>2</sup>) com cordões.

∓ 360 x 420 mm

↗ TXP – 250 x 250 mm



103

**NEW**

**Neeson** — 98093

Anti-estresse em espuma PU em formato de bola de futebol.

∓ ∅63 mm

➤ PDP – 10 x 10 mm



106

**NEW**

**Lohan** — 98091

Anti-estresse em espuma PU em formato de carro.

∓ 52 x 93 x 47 mm

➤ PDP – 40 x 10 mm



128

**NEW**

**Hous** — 98057

Anti-estresse em espuma PU em formato de casa.

∓ 70 x 80 x 70 mm

➤ SCR – 50 x 25 mm



105

**Deep** — 98012

Anti-estresse em espuma PU em formato de coração.

∓ 65 x 70 x 50 mm

➤ PDP – 25 x 15 mm

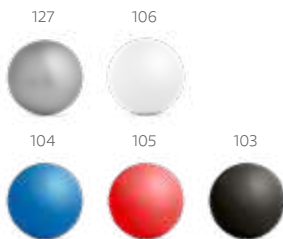

**Chill** — 98054

Anti-estresse em espuma PU em formato de bola, disponível em várias cores.

∓ ∅50 mm

➤ DUV – 25 x 20 mm



127

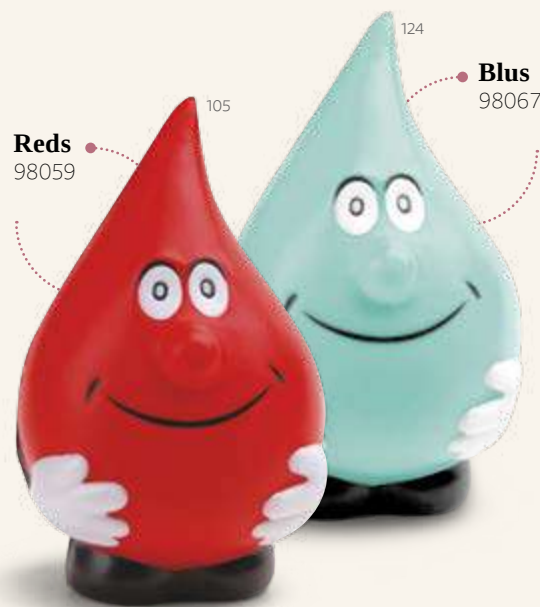

**Reds**  
98059

105

124

**Blus**  
98067

**Blus** — 98067

**Reds** — 98059

Anti-estresse em espuma PU em formato de gota.

∓ 65 x 110 x 65 mm

➤ PDP – 25 x 15 mm







O campismo é a melhor escolha para quem procura contato direto com a natureza e é uma excelente opção amiga do ambiente.

Suporta até **100kg**



**Heiden** — 99078  
 .288



**Thorpe** — 99074

Manta em tecido polar (180 g/m<sup>2</sup>) com alça removível para facilitar o transporte.

▮ 1500 x 1200 mm  
 ▮ TRS - 90 x 35 mm

Suporte para Squeeze

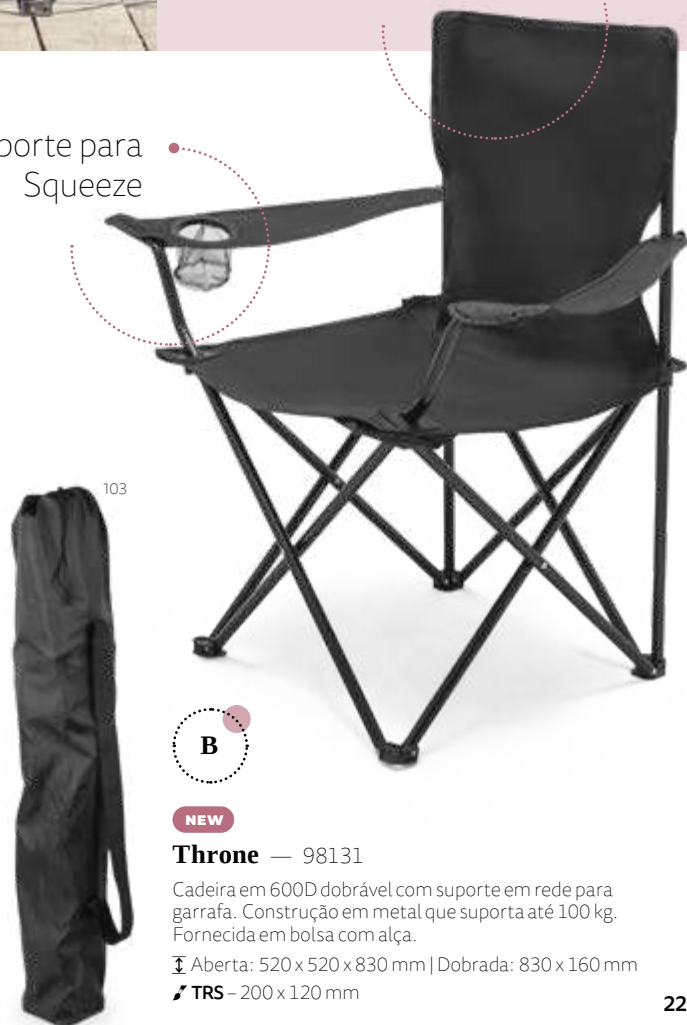

**NEW**

**Throne** — 98131

Cadeira em 600D dobrável com suporte em rede para garrafa. Construção em metal que suporta até 100 kg. Fornecida em bolsa com alça.

▮ Aberta: 520 x 520 x 830 mm | Dobrada: 830 x 160 mm  
 ▮ TRS - 200 x 120 mm

## Bons aliados

O canivete é um dos acessórios mais úteis durante atividades ao ar livre como campismo, montanhismo e pesca. Opte pelos que têm fecho de segurança para maior proteção.



A



103



Inox **Ninja** — 94036

Canivete em aço inox e metal com fecho de segurança e clipe. Fornecido em caixa presente.

115 x 15 x 32 mm |  
Caixa: 125 x 42 x 20 mm  
LSR – 35 x 10 mm



103



Inox **Alick** — 94035

Canivete em aço inox e metal com fecho de segurança e clipe. Fornecido em caixa presente.

97 x 15 x 29 mm |  
Caixa: 110 x 37 x 20 mm  
LSR – 50 x 12 mm

Com mosquetão



103



A

Inox **Fred** — 94037

Canivete em aço inox e metal com fecho de segurança e mosquetão. Fornecido em caixa presente.

101 x 10 x 29 mm |  
Caixa: 108 x 39 x 15 mm  
LSR – 30 x 8 mm





B



**Inox** **Lawrence** — 94030  
 Canivete em aço inox e madeira com fecho de segurança e clipe.  
 † 115 x 16 x 36 mm  
 ⚡ LSR - 25 x 5 mm

Com fecho de segurança



170



B

**Inox** **Falcon II** — 94031  
 Canivete em aço inox e madeira com fecho de segurança.  
 † 110 x 19 x 30 mm  
 ⚡ LSR - 50 x 6 mm



170



**Inox** **Split** — 94038  
 Canivete em aço inox e madeira com fecho de segurança. Fornecido em caixa presente.  
 † 84 x 11 x 24 mm | Caixa: 94 x 33 x 16 mm  
 ⚡ LSR - 30 x 10 mm



160



**Inox** **Norris** — 94032

Faca em aço inox e madeira com bolsa de 600D. Fornecida em caixa.

☒ 300 x 19 x 60 mm

🔪 LSR - 40 x 10 mm



• **12** funções



**Inox** **Wild** — 94040

☑️ Canivete multifunções em aço inox com 12 peças e mosquetão. Fornecido em caixa presente.

☒ 89 x 16 x 32 mm |

Caixa: 104 x 39 x 20 mm

🔪 LSR - 25 x 7 mm



**Inox** **Belpiano** — 94159

Canivete multifunções em aço inox e madeira com 5 funções.

☒ 90 x 25 x 12 mm

🔪 LSR - 50 x 8 mm



**Verbier** — 94192

Canivete multifunções em ABS e metal com 5 funções.

☒ 59 x 17 x 8 mm

🔪 PDP - 40 x 9 mm





Chaveiros  
& Lanternas





B

A

C



## Chaveiros amigos do ambiente

A cortiça é um material biodegradável e nobre, cuja transformação resulta em objetos leves, de toque suave e resistentes à humidade e ao atrito.



A



**ECologic**



**Millau** — 95051

Chaveiro em cortiça. Fornecido com caixa presente desmontada em cartão craft.

▮ 35 x 55 x 3 mm

▮ LSR - Ø20 mm

B



**ECologic**



**Raldic** — 93371

Chaveiro em cortiça e metal. Fornecido em caixa craft.

▮ 24 x 47 x 3 mm

▮ LSR - 33 x 13 mm

C



**ECologic**



**Aloy** — 95050

Chaveiro em cortiça em formato retangular. Fornecido com caixa presente desmontada em cartão craft.

▮ 35 x 60 x 3 mm

▮ LSR - 35 x 20 mm





## Escolhas amigas do ambiente



160

A

ECOLOGIC

 **Lavre** — 93324

 Kit esferográfica e chaveiro em metal com acabamento em cortiça. Esferográfica com 1,5 km de escrita a azul. Fornecido em caixa presente de papel craft.

✂ Esferográfica: Ø9 x 139 mm | Porta-chaves: 24 x 47 x 3 mm | Caixa: 162 x 83 x 17 mm

✂ DUV – 100 x 50 mm



160

B

ECOLOGIC

 **Corks** — 93145

Chaveiro em cortiça e metal. Fornecido em caixa presente de papel craft.

✂ 20 x 100 mm | Caixa: 54 x 125 x 16 mm

✂ TRS – 10 x 50 mm



## Presentes únicos



### **Travolta** — 93314

Kit de porta cartões e chaveiro em c. sintético e metal. Fornecido em caixa almofadada.

☿ Chaveiro: 15 x 92 x 8 mm |  
Porta cartões: 97 x 65 x 11 mm |  
Caixa: 154 x 143 x 34 mm

🔪 LSR - 25 x 7 mm



### **Brendon** — 93315

Kit de porta cartões, chaveiro e esferográfica em c. sintético, metal e alumínio. Esferográfica com ponteira touch. Fornecido em caixa almofadada.

☿ Porta cartões: 97 x 65 x 11 mm |  
Chaveiro: 15 x 92 x 8 mm | Esferográfica: Ø11 x 135 mm |  
Caixa: 174 x 163 x 34 mm

🔪 LSR - 35 x 6 mm





**Lone** — 93318  
 Porta cartões em metal e c. sintético.  
 Fornecido em caixa.  
 93 x 67 x 19 mm | Caixa: 98 x 72 x 22 mm  
 LSR – 70 x 7 mm



**Millard** — 93280  
 Porta cartões em metal e c. sintético.  
 Fornecido em caixa presente.  
 95 x 64 x 13 mm  
 LSR – 80 x 8 mm



**Smith** — 93308  
 Porta cartões em metal e c. sintético.  
 Fornecido em caixa.  
 97 x 63 x 14 mm |  
 Caixa: 105 x 70 x 15 mm  
 LSR – 50 x 10 mm



## Porta cartões com bloqueio RFID



**Poppy** — 93265  
 Porta cartões em PU com bloqueio de RFID e fita em poliéster para retirar facilmente seus cartões. Com capacidade para guardar até 2 cartões.  
 92 x 65 mm  
 SCR – 45 x 45 mm



**Muller** — 93332  
 Porta cartões em alumínio com bloqueio de RFID e fita elástica em poliéster. O porta cartões tem acabamento mate e capacidade para 12 cartões. Seu formato compacto e funcionalidade de bloqueio RFID permitem que seja guardado de forma cômoda e segura em bolsos.  
 90 x 58 mm  
 LSR – 50 x 20 mm



**Dunedin** — 93322  
 Porta cartões em alumínio.  
 95 x 55 x 6 mm  
 LSR – 80 x 30 mm





A



103

Com mosquetão giratório



**Bourchier** — 93363  
 Chaveiro em c. sintético e metal com mosquetão. Fornecido em caixa presente.  
 21 x 77 x 8 mm  
 LSR - 15 x 20 mm



103

A

NEW



**Blackwall** — 93353  
 Chaveiro em metal e c. sintético. Fornecido em caixa presente.  
 21 x 100 x 11 mm  
 LSR - 15 x 6 mm





114



114

Com mosquetão giratório

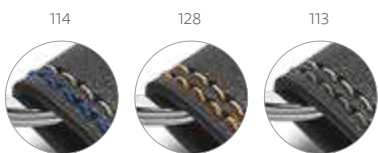

114

128

113



**Bale** — 93143

Chaveiro em c. sintético e metal. Fornecido em caixa presente.

∓ 22 x 65 x 8 mm

↗ LSR – 15 x 33 mm

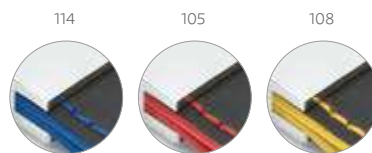

114

105

108



**Leskov** — 93370

Chaveiro em c. sintético e metal com mosquetão giratório. Fornecido em caixa presente.

∓ 17 x 80 x 7 mm

↗ LSR – 13 x 20 mm



103

A



**Bachmann** — 93171

Chaveiro em c. sintético e metal. Fornecido em caixa presente.

∓ 38 x 76 x 9 mm

↗ LSR – 10 x 25 mm



A



**KLoden** — 93172  
 Chaveiro em c. sintético e metal.  
 Fornecido em caixa presente.  
 39 x 74 x 5 mm  
 LSR - 18 x 30 mm



**Kendal** — 93156  
 Chaveiro em c. sintético e metal.  
 Fornecido em caixa.  
 34 x 70 x 4 mm  
 LSR - 15 x 35 mm



**Froome** — 93396  
 Chaveiro em metal. Fornecido  
 em caixa presente.  
 32 x 53 x 4,5 mm  
 LSR - 25 x 12 mm



**Diamond** — 93395  
 Chaveiro em metal. Fornecido  
 em caixa presente.  
 28 x 47 x 4,5 mm  
 LSR - 22 x 14 mm

# Chaveiros em metal



Com abridor de squeezes



Com abridor de squeezes



107

NEW

## Blake — 93367

Chaveiro em metal com abridor de garrafas. Fornecido com bolsa de non-woven.

∩ 36 x 67 x 3 mm | Bolsa: 60 x 100 mm

⚡ LSR - Ø18 mm



107



## Ringbolt — 93368

Chaveiro em metal com abridor de garrafas. Fornecido em caixa presente.

∩ 29 x 52 x 4 mm

⚡ LSR - 15 x 27 mm



107

## Helli — 93394

Chaveiro em metal com abridor de garrafas.

∩ 22 x 42 x 9 mm

⚡ LSR - 20 x 9 mm



127

NEW



## Zabel — 93158

Chaveiro em metal. Fornecido em caixa presente.

∩ 30 x 54 x 4 mm

⚡ LSR - 30 x 17 mm



107



## Ulrich — 93084

Chaveiro em metal em formato de casa. Fornecido em caixa presente.

∩ 49 x 36 x 3 mm

⚡ LSR - 30 x 15 mm





A

NEW



**Wagoner** — 93341

Chaveiro em metal em formato de caminhão. Fornecido em caixa de oferta.

∓ 26 x 71 x 3 mm

LSR – 35 x 15 mm

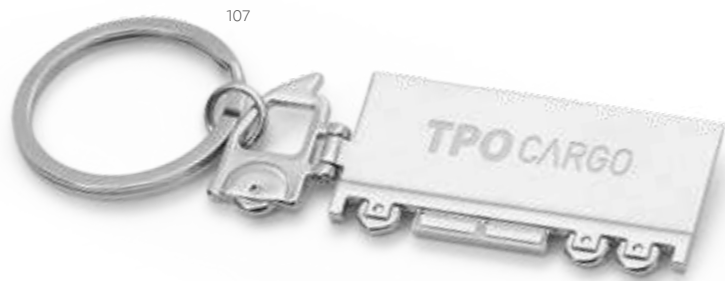

107



103



103

A



**Jamp** — 93155

Chaveiro em metal. Fornecido em caixa.

∓ 30 x 35 x 5 mm

LSR – 18 x 22 mm



NEW



**Flemi** — 93397

Chaveiro em metal. Fornecido em caixa presente.

∓ 28 x 52 x 3 mm

LSR – 20 x 25 mm





**Paw** — 93364

Chaveiro em formato de osso em alumínio.

▮ 38 x 25 x 1 mm

⚡ LSR - 25 x 10 mm



**Mobby** — 93165

Chaveiro em formato de carro em alumínio.

▮ 45 x 36 x 2 mm

⚡ LSR - 17 x 17 mm



**Homier** — 93167

Chaveiro em formato de casa em alumínio.

▮ 38 x 35 x 2 mm

⚡ LSR - 25 x 22 mm



**Beat** — 93159

Chaveiro em formato de coração em alumínio.

▮ 36 x 34 x 2 mm

⚡ LSR - 20 x 15 mm



**Stitch** — 93356

Chaveiro em alumínio.

▮ 29 x 54 x 1 mm

⚡ LSR - 20 x 30 mm

## Formatos originais para presentes diferentes



103



119



128

A

### Becket — 93372

Chaveiro em metal e ABS.

▮ 29 x 40 x 4 mm

⚡ LSR - 25 x 25 mm

B

### Basso — 93391

Chaveiro em formato de coração em metal e ABS.

▮ 42 x 34 x 4 mm

⚡ LSR - 20 x 15 mm



105

C

### Vivre — 93392

Chaveiro em formato de casa em metal e ABS.

▮ 42 x 37 x 4 mm

⚡ LSR - 25 x 20 mm



114





114



114

105

107

147

103



104



103



3 luzes LED



**LED Lergan** — 93141

Chaveiro em alumínio com lanterna de 3 luzes LEDs. Incluso 4 pilhas LR44.

∅17 x 62 mm

LSR – 7 x 30 mm

109



114



105



103



104

103

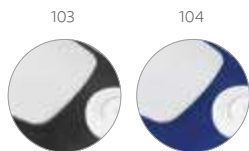

103

104

**LED Gobo** — 94006

Chaveiro com lanterna LED e ferramenta. Incluso 4 pilhas LR41.

62 x 30 x 12 mm

PDP – 50 x 15 mm

**LED Cleat** — 93360

Chaveiro em ABS com luz LED. Incluso 3 pilhas AG10.

31 x 77 x 14 mm

PDP – 15 x 35 mm

**NEW**

**LED Brighter** — 94746



Chaveiro com lanterna em alumínio e LED interior. Incluso 4 pilhas LR44. Fornecida em caixa presente.

Fechada: Ø17 x 65 mm |

Caixa: 73 x 33 x 25 mm

LSR – 30 x 8 mm

## Chaveiros com funções extra



114



103

Com abridor de squeezes



147

6 luzes LED



LED

**Pantani** — 93140

Chaveiro com LED e abridor de garrafas. Incluso 2 pilhas LR41.

∅ 34 x 68 x 11 mm

LSR — 18 x 27 mm



LED

**Screebe** — 94729

Lanterna em alumínio com 6 LEDs, abridor de garrafas e mosquetão. Incluso 2 pilhas CR2032.

∅ 25 x 102 mm

LSR — 40 x 8 mm

Com abridor de squeezes



103



109



127



114



114



147

LED

**Leif** — 93154

Chaveiro em metal com lanterna LED e abridor de garrafas. Incluso 3 pilhas LR41.

∅ 14 x 62 mm

LSR — 5 x 28 mm



LED

**Torchen** — 93267

Lanterna em metal com 3 LEDs, abridor de garrafas e chaveiro. Incluso 3 pilhas LR44.

∅ 18 x 72 mm

LSR — 23 x 7 mm

3 luzes LED



**Baitt** — 93151

Chaveiro em alumínio com abridor de garrafas.

∓ 11 x 60 x 15 mm  
 ↗ LSR – 40 x 8 mm



**Clane** — 94195

Chaveiro em alumínio com abridor de garrafas.

∓ 15 x 68 x 13 mm  
 ↗ LSR – 25 x 8 mm

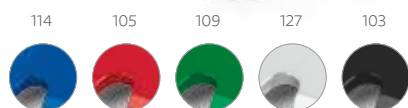

**Kilmoon** — 94196

Chaveiro em alumínio com abridor de garrafas.

∓ 30 x 89 x 2,5 mm  
 ↗ LSR – 20 x 20 mm

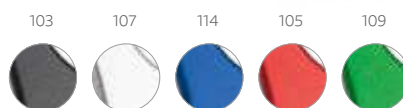

**Close** — 98824

Mosquetão em alumínio com abridor de garrafas. Não adequado para escalada esportiva.

∓ 44 x 79 x 3 mm  
 ↗ LSR – 50 x 5 mm







A



A

**Nate** — 53197  
 Chaveiro multifunções em metal.  
 13 x 55 x 7 mm  
 LSR - 45 x 8 mm



**Verbier** — 94192  
 .228

**Trudy** — 93398  
 Chaveiro em metal com apito.  
 Ø7 x 45 mm  
 LSR - 20 x 6 mm

Com apito



127  
 114  
 105  
 103

Suporte para celular



**Nicolaus** — 94446

Porta cartões em silicone com cordão e suporte para celular.

Porta-cartões: 57 x 86 x 4 mm | Lanyard: 420 mm

SCR – 35 x 35 mm

Chaveiro no interior



**Miller** — 93124

Bolsa pequena multiusos em 600D com fecho de correr e chaveiro no interior.

120 x 80 mm

TRS – 90 x 40 mm





Casa,  
Restaurante & Bar





B

C

A



## Elegância nos jantares de família

De diferentes tamanhos e formatos, tábuas de bambu, um material Ecológic e de qualidade para associar à sua marca.



A

NEW

Ecológic



B

NEW

Ecológic



C

NEW

Ecológic



**Caraway Round** — 94259

Tábua de servir em bambu com pega, de grande dimensão e de utilização versátil. Ideal para pizza. Food grade. Fornecido com caixa presente de papel craft.

310 x 408 x 12 mm

LSR – 70 x 9 mm



**Caraway** — 94260

Tábua de servir em bambu com pega, de grande dimensão e de utilização versátil. Food grade. Fornecido com caixa presente de papel craft.

240 x 450 x 12 mm

LSR – 70 x 9 mm



**Caraway Long** — 94258

Tábua de servir em bambu com pega, de grande dimensão e de utilização versátil. Food grade. Fornecido com caixa presente de papel craft.

155 x 600 x 12 mm

LSR – 70 x 9 mm





B



A



160

A

**ECologic**

**Pepper** — 93968

Saladeira em bambu em formato quadrado. Adicione o conjunto SALVY de 2 talheres para salada em bambu para compor este brinde ecológico. Food grade.

214 x 214 x 70 mm

LSR – 70 x 70 mm

Cabo com acabamento aborrachado

160



B

**ECologic**

**Salvy** — 93969

Conjunto de 2 talheres para salada em bambu. Food grade.

300 x 60 mm

LSR – 140 x 13 mm

**ECologic**

**Lestini** — 94110

Suporte para facas em madeira de pinho. Incluso conjunto de 5 facas de cozinha: faca utilitária média, faca utilitária pequena, faca para vegetais, faca para pão e faca para carne. Peças em aço inox e PP, cabo com acabamento emborrachado. Próprio para contato com alimento.

150 x 310 x 85 mm

LSR – 70 x 70 mm





C



160

**ecologic**

**Koerper** — 94111

Kit churrasco em caixa de bambu. Composto por 4 utensílios em aço inox e bambu: faca japonesa, faca chefe, faca boning e garfo. Food grade.

Caixa: 350 x 179 x 29 mm

LSR - 70 x 70 mm



160

NEW

**ecologic**

**Marjoram** — 94261

Tábua de corte em bambu. Food grade. Fornecido com caixa presente de papel craft.

400 x 300 x 15 mm

LSR - 70 x 9 mm

C

# Convívios em casa

Leve a sua marca para os almoços de família ou jantares de amigos.



160



**ecologic**

**Malvia** — 93975

Tábua de queijos em bambu com faca incluída. Food grade. Fornecido em caixa presente de papel craft.

300 x 260 x 15 mm | Caixa: 307 x 267 x 21 mm

LSR - 150 x 50 mm



160



**ecologic**

**Palermo** — 93976

Tábua de queijos em bambu e aço inox com 3 talheres. Fornecida em caixa de cartão. Food grade.

330 x 195 x 16 mm | Caixa: 335 x 205 x 30 mm

LSR - 100 x 20 mm



160

A

**ecologic**

**Woods** — 93830

Tábua de queijos em bambu com 2 utensílios em bambu e aço inox. Food grade. Fornecido em caixa presente de papel craft.

310 x 180 x 15 mm | Caixa: 316 x 186 x 25 mm

LSR - 90 x 90 mm



A





160

**B**

NEW



**ecologic**



**Cappero** — 94028

Conjunto com tábua de corte e pequena faca de queijo em bambu. Food grade. Fornecido em caixa presente de papel craft.

☿ 143 x 200 x 10 mm |  
Caixa: 150 x 205 x 32 mm  
/ LSR – 50 x 6 mm



**ecologic**

**B**



160

**ecologic**



**Capers** — 93966

Tábua de servir em bambu. Food grade.

☿ 200 x 143 x 9 mm  
/ LSR – 140 x 90 mm



160

**ecologic**



**Banon** — 93880

Tábua de servir em bambu. Food grade.

☿ 300 x 200 x 9 mm  
/ LSR – 140 x 90 mm





NEW

ECologic



**Monco** — 92836

Sacola para pão 100% algodão (100 g/m<sup>2</sup>) com cordão para fechar.

∓ 220 x 560 mm

↗ LSR - 150 x 280 mm

Com suporte para copo



ECologic



**Fabris** — 93829



Prato em bambu com suporte para copo. Ideal para servir aperitivos. Food grade. Fornecido em luva de cartão.

∓ 200 x 147 x 13 mm | Manga: 160 x 148 x 14 mm

↗ LSR - 70 x 70 mm

## Essenciais de cozinha

Dois reservatórios



NEW



**Charles** — 93875

Galheteiro em vidro que contém dois reservatórios com capacidades de até 50 ml e de até 250 ml. O galheteiro contém duas rolhas de cortiça. Food grade. Fornecido em caixa presente.

∓ Ø57 x 155 mm | Caixa: 75 x 175 x 75 mm

↗ PDP - 11 x 50 mm



**Smartpepper** — 93989



Salheiro ou pimenteiro em aço inox.

∓ Ø27 x 153 mm

↗ LSR - 30 x 8 mm

Até 1 hora

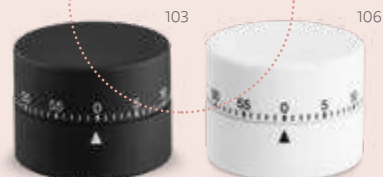

**Montigny** — 97389

Temporizador de cozinha em ABS e com acabamento emborrachado.

∓ Ø59 x 45 mm

↗ SCR - Ø40 mm



ecologic

**Mustard** — 93861



Travessa em bambu, indicada para servir alimentos. Fornecida em caixa de cartão. Food grade.

☿ 255 x 130 x 18 mm | Caixa: 260 x 134 x 26 mm

➤ LSR - 100 x 50 mm



160

Fita para pendurar



160



ecologic

**Sesame** — 93831



Tábua em bambu ideal para servir aperitivos, com fita para pendurar. Fornecida em luva de cartão. Food grade.

☿ 420 x 134 x 9,6 mm | Manga: 200 x 135 x 10 mm

➤ LSR - 90 x 90 mm



100

ecologic

**Pickled** — 93885



Base de mesa em bambu com 3 potes em silicone. Fornecida em caixa craft. Food grade.

☿ Taças: 87 x 87 x 50 mm | Base: 300 x 105 x 9 mm | Caixa: 310 x 110 x 28 mm

➤ LSR - 140 x 15 mm



100

ecologic

**Paprika** — 93898



Base de mesa em bambu com 2 potes retráteis em silicone. Fornecido em caixa de papel craft. Food grade.

☿ Taças: 87 x 87 x 50 mm | Base: 347 x 168 x 19 mm | Caixa: 355 x 175 x 30 mm

➤ LSR - 60 x 40 mm

# Mestre do churrasco

Kits com utensílios essenciais para preparar um excelente churrasco para a família e amigos.



103

## **Garlic King** — 94142

 Kit churrasco em estojo de 210D. Composto por tábua em bambu e 5 utensílios em aço inox e madeira de Seringueira: faca chefe, faca média, pinça, garfo e afiador. Próprio para contato com alimento.

 Estojo: 350 x 230 x 40 mm |  
Tábua: 300 x 230 x 12 mm

 TRS – 250 x 150 mm



103

## **Moussaka** — 94107

 Kit churrasco em estojo de 210D. Composto por tábua em bambu e 3 utensílios em aço inox e madeira de Seringueira: faca japonesa, garfo e afiador. Próprio para contato com alimento.

 Estojo: 220 x 345 x 30 mm |  
Tábua: 300 x 200 x 11,6 mm

 TRS – 200 x 120 mm



103

## **Garlic** — 94145

 Kit churrasco em estojo de 210D. Composto por 3 utensílios em aço inox e madeira de Seringueira: faca chefe, pinça e garfo. Próprio para contato com alimento.

 Estojo: 350 x 130 x 20 mm

 TRS – 280 x 60 mm





103



### Teriyaki — 94104

Kit churrasco em estojo de PU e 210D. Composto por tábua em bambu e 7 utensílios em aço inox e madeira de Seringueira: faca japonesa, faca chefe, garfo, pinça, faca pequena, afiador e pincel. Próprio para contato com alimento.

Estojo: 250 x 370 x 45 mm | Tábua: 300 x 200 x 11,6 mm

TR5 – 200 x 120 mm



**ECÓlogic**

**A**



**Alioli King** — 94140

Kit churrasco em caixa craft. Composto por 4 peças em aço inox e bambu: faca chefe, faca japonesa, garfo e pinça. Próprio para contato com alimento.

Caixa: 365 x 200 x 55 mm

LSR – 30 x 12 mm



**ECÓlogic**



**Alioli Board** — 94143

Kit churrasco em caixa craft. Composto por tábua em bambu e 2 utensílios em aço inox e bambu: faca chefe e garfo. Food grade.

Caixa: 360 x 210 x 40 mm | Tábua: 300 x 200 x 12 mm

LSR – 30 x 10 mm



**ECÓlogic**



**Alioli** — 94139

Kit churrasco em caixa craft. Composto por 2 utensílios em aço inox e bambu: faca chefe e garfo. Próprio para contato com alimento.

Caixa: 340 x 115 x 25 mm

LSR – 30 x 12 mm





160



ecologic



**Bottura** — 93844



Kit churrasco em estojo de bambu. Composto por 6 peças em aço inox e bambu: faca chefe, faca média, faca japonesa, pinça, garfo e afiador. Food grade.



Estojo: 455 x 160 x 65 mm

LSR - 140 x 90 mm



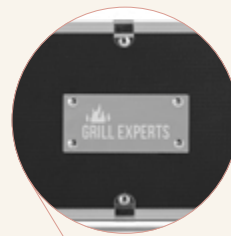

**Valastro** — 94109

 **Inox** Kit churrasco em estojo de alumínio. Composto por 5 utensílios em aço inox e alumínio: faca chefe, faca japonesa, faca boning, garfo e afiador. Próprio para contato com alimento.

Estojo: 385 x 120 x 69 mm | Placa: 75 x 35 mm

LSR - 60 x 20 mm



**Annatto** — 94141

 **Inox** Kit churrasco em estojo de alumínio. Composto por 4 utensílios em aço inox: faca chefe, pinça, garfo e espátula. Próprio para contato com alimento.

Estojo: 385 x 110 x 80 mm | Placa: 60 x 30 mm

LSR - 50 x 20 mm



**Mace** — 93845

 **Inox** Kit churrasco em estojo de alumínio. Composto por luva de cozinha em poliéster e 6 utensílios em aço inox: faca chefe, 1 faca japonesa, 1 pinça, 1 garfo, 1 espátula e 1 afiador. Próprio para contato com alimento.

Estojo: 450 x 170 x 80 mm | Placa: 80 x 50 mm

LSR - 50 x 30 mm



**Champ** — 94112



Kit churrasco composto por 4 utensílios: faca, garfo e pinça em aço inox e madeira de Seringueira e uma luva de cozinha. O estojo dobrável em 600D pode ser convertível em avental para sua proteção. Próprio para contato com alimento.

☒ Dobrado e fechado: 130 x 480 mm.

☑ TRS – 140 x 95 mm

**Kit 2 em 1, convertível em avental e com os utensílios necessários para os melhores grelhados**





**Cubat** — 94138

 Kit churrasco em estojo de 210D. Composto por 2 utensílios em aço inox e madeira Seringueira: faca chefe e garfo. Próprio para contato com alimento.

 Estojo: 350 x 130 x 20 mm

 TRS - 280 x 60 mm



**Durand** — 94136

 Kit churrasco em estojo de 210D. Composto por 2 utensílios em aço inox: faca chefe e garfo. Próprio para contato com alimento.

 Estojo: 350 x 130 x 20 mm

 TRS - 280 x 60 mm



**Jullemier** — 94137

 Kit churrasco em estojo de 210D. Composto por 2 utensílios em aço inox e PP: faca chefe e garfo. Próprio para contato com alimento.

 Estojo: 350 x 130 x 20 mm

 TRS - 280 x 60 mm





### Ravioli — 94102

Kit churrasco em estojo de 210D com peças em aço inox e PP. Composto por tábua em PP e 3 utensílios: faca chefe, garfo e afiador. Próprio para contato com alimento.

Estojo: 220 x 345 x 30 mm |  
Tábua: 195 x 285 x 5 mm

TR5 – 200 x 120 mm



### Botaly — 94144

Kit churrasco em estojo de nylon 210D. Composto por tábua em PP e 5 utensílios em aço inox e PP: faca chefe, faca boning, faca pequena, garfo e afiador. Próprio para contato com alimento.

Estojo: 350 x 230 x 40 mm |  
Tábua: 283 x 192 x 5 mm

TR5 – 250 x 150 mm

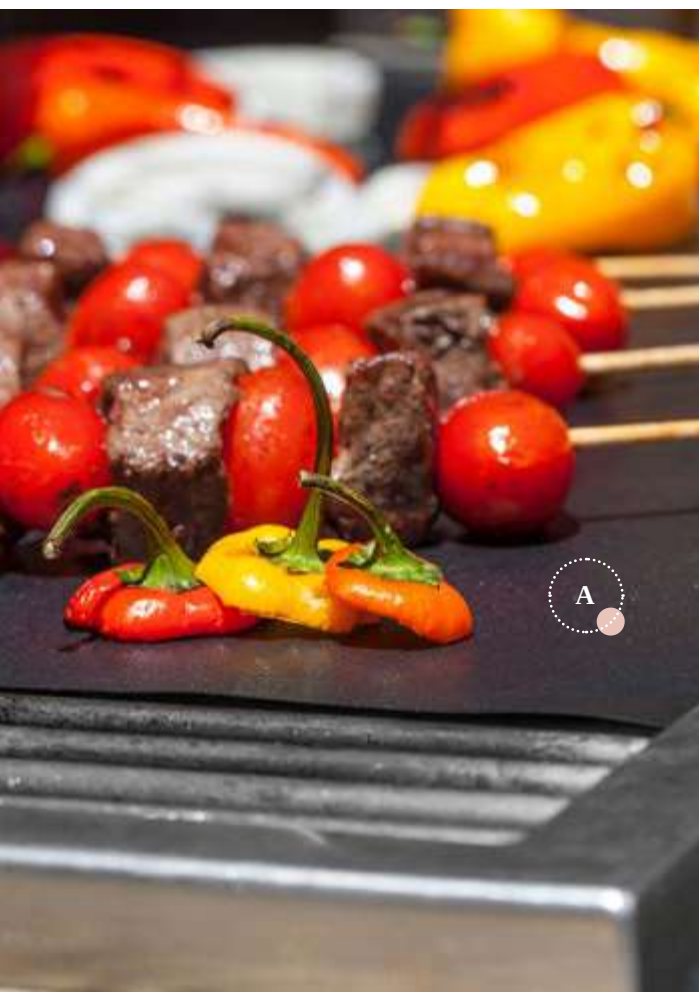

## Inclua no seu kit de churrasco esta esteira. Eleve seus grelhados

Chives  
99822  
R\$ .284



### Atala — 94101

Esteira para grelha em PTFE. Indicada para colocar em cima das grelhas de churrasco para que a comida não grude.

400 x 300 mm





Vedante em silicone

NEW



### Portobello — 94781



Marmita em vidro borossilicato e tampa em bambu com vedante em silicone. Apto para o microondas e máquina de lavar, retirando a tampa. Capacidade até 1L. Food grade. Fornecida em caixa presente de papel craft.



196 x 145 x 64 mm | Caixa: 202 x 150 x 66 mm

LSR – 120 x 80 mm

Válvula de duas posições



NEW



### Reina — 93850



Marmita em vidro borossilicato com tampa em PP e capacidade até 600 ml. A tampa incorpora uma válvula de duas posições (aberta e fechada). Apta para máquina de lavar louça e microondas (retirando a tampa).



175 x 62 x 131 mm

PDP – 50 x 30 mm





## Comida caseira

Torne as suas rotinas mais sustentáveis e leve refeições preparadas em casa.



York  
98428

📦 .315



NEW

EcoLogic

Shino — 94025

800 ml



Marmita em aço inox e tampa em bambu com banda elástica para um transporte mais seguro. Capacidade até 800 ml. Food grade. Fornecida em caixa de papel craft.

📏 165 x 115 x 52 mm

📏 LSR – 140 x 90 mm

160



• Com elástico para um transporte seguro





B

A



A

700 ml



NEW

ecologic



**Spice 700** — 94079

Frasco em vidro borossilicato e tampa de cortiça. Capacidade até 700ml. Food grade. Fornecido em caixa presente de papel craft.

± Ø95 x 110 mm

LSR - Ø70 mm



B

380 ml



NEW

ecologic



**Spice 380** — 94099

Frasco em vidro borossilicato e tampa de cortiça. Capacidade até 380ml. Food grade. Fornecido em caixa presente de papel craft.

± Ø95 x 60 mm

LSR - Ø70 mm

C

1L



NEW

ecologic



**Jasmin 1000** — 94236

Squeeze em vidro borossilicato com tampa de cortiça. Capacidade até 1L. Food grade. Fornecido em caixa presente de papel craft.

± Ø83 x 215 mm

LSR - Ø55 mm



D

800 ml



NEW

ecologic



**Jasmin 800** — 94235

Squeeze em vidro borossilicato com tampa de cortiça. Capacidade até 800 ml. Food grade. Fornecido em caixa presente de papel craft.

± Ø80 x 190 mm

LSR - Ø50 mm





160

### ECologic



**Hibiscus** — 93978



Caixa de chás em bambu, com 4 compartimentos e fecho com ímã. Fornecido em caixa presente de papel craft.



∓ 160 x 160 x 78 mm |  
Caixa kraft: 166 x 166 x 85 mm

↗ LSR - 140 x 140 mm



160

### ECologic



**Verbena** — 93977



Caixa de chás em bambu, com 2 compartimentos e fecho com ímã. Fornecida em caixa presente de papel craft.



∓ 160 x 87 x 78 mm | Caixa kraft: 166 x 91 x 87 mm

↗ LSR - 140 x 70 mm

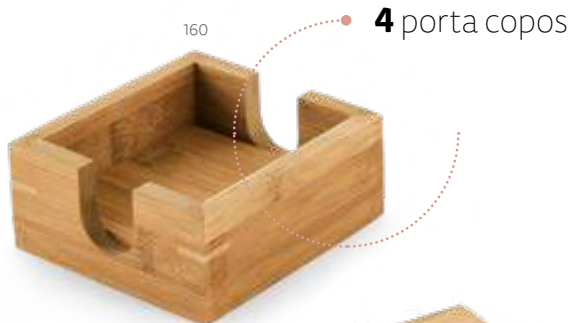

160

4 porta copos



### ECologic



**Gauthier** — 93967

Conjunto de 4 porta copos em bambu com caixa aberta. Fornecido em caixa presente de papel craft.

∓ 115 x 115 x 35 mm |  
Base copo: 100 x 100 x 6 mm |  
Caixa: 119 x 121 x 56 mm

↗ LSR - 80 x 80 mm



160



NEW

### ECologic



**Pisani** — 93828

Porta copos redondo em cortiça.

∓ Ø100 x 5 mm

↗ LSR - Ø70 mm



160

### ECologic



**Garcia** — 93827

Porta copos em cortiça em formato quadrado com cantos arredondados.

∓ 100 x 100 x 5 mm

↗ LSR - 80 x 80 mm





160

**ecologic**

**Moreto** — 94119

Conjunto para vinho com 4 peças em madeira e metal: saca-rolhas com canivete de sommelier, gargantilha, salva-gotas com tampa e rolha. Fornecido em caixa presente em cortiça.

∓ Ø144 x 42 mm

↗ LSR - Ø90 mm



170

• Com sistema de mola para extração em duas fases



**NEW**

**Inox Chaptal** — 94243

Saca-rolhas em madeira e aço inox. Com sistema de mola para extração em duas fases. Com canivete de escanção.

∓ 120 x 28 x 13 mm

↗ LSR - 15 x 5 mm



160

**ecologic**

**Cabernet** — 94190

Conjunto para vinho em bambu e zinco. Incluso saca-rolhas com canivete de sommelier, termômetro, rolha e gargantilha.

∓ 147 x 167 x 54 mm

↗ LSR - 120 x 90 mm



160

**ecologic**

**Syrah** — 94189

Conjunto para vinho em bambu e zinco. Incluso saca-rolhas com canivete de sommelier, gargantilha, salva-gotas com tampa e rolha.

∓ 363 x 112 x 119 mm

↗ LSR - 140 x 90 mm



B

A

“New  
vament”



NEW

**Merlot** — 94249

Saca rolhas elétrico em ABS com 4 pilhas AA inclusas. Inclui corta-cápsulas. Fornecido em caixa presente.

☿ Saca rolhas: Ø48 x 230 mm | Caixa: 54 x 54 x 250 mm

🔪 PDP – 30 x 15 mm



Saca rolhas elétrico

A

NEW

**Winery** — 94248

Conjunto de saca rolhas elétrico e acessórios em ABS e TPE. Incluso corta cápsulas, rolha de vácuo e salva-gotas. Com pilhas incluídas. Fornecido com caixa presente.

☿ Saca rolhas: 45 x 227 mm | Caixa: 241 x 90 x 54 mm

🔪 PDP – 20 x 15 mm



Saca rolhas elétrico

Inclui corta cápsulas, rolha de vácuo e vertedor de vinho anti-gota



127

**Barrel** — 94191

Conjunto para vinho em zinco. Incluso saca-rolhas com canivete de sommelier e rolha. Fornecido em caixa presente.

☿ 103 x 133 x 28 mm

🔪 SCR – 100 x 75 mm

B



NEW

**Blend** — 94247

Manga refrigeradora em nylon com elástico nas laterais. Fornecido em caixa presente.

☿ 160 x 230 mm

🔪 TRS – 140 x 90 mm

Ideal para squeezez mais largas



103





**Macabeu** — 94193

Luva refrigeradora em nylon 190T com fecho em velcro.

∓ 326 x 230 mm

↗ TRS - 220 x 25 mm



110



**Colombia** — 94194

Sacola refrigeradora para 1 garrafa em PVC com alças de 35 cm.

∓ 100 x 250 x 100 mm

↗ SCR - 60 x 20 mm



103



**Vermentino** — 93892

Rolha de vácuo para garrafa em ABS. Food grade.

∓ Ø48 x 73 mm

↗ PDP - 10 x 40 mm



115



104



103

**Baird** — 92844

Sacola para 1 garrafa em non-woven (80 g/m<sup>2</sup>) com alças.

∓ 100 x 330 x 100 mm

↗ TRS - 60 x 230 mm



B

A



A



**EcoLogic**

**Jerome** — 92883

Sacola para garrafa 100% algodão (180 g/m<sup>2</sup>) com cordão para fechar, também em algodão.

150 x 340 mm

TR5 - 200 x 140 mm

160



160

B



**EcoLogic**

**Borba** — 92819

Sacola em cortiça para 1 garrafa. Sacola amiga do ambiente com 2 alças e janela na parte frontal, ideal para oferta.

100 x 330 x 100 mm

TR5 - 60 x 80 mm





**Funfaye** — 94116

Porta copos em ABS com abridor de garrafas e esponja antiderrapante na base.

☒ 82 x 82 x 4 mm  
 ⚡ PDP — 30 x 25 mm

Esponja antiderrapante na base



**Holz** — 94134  
 Abridor de garrafas em metal com cabo em madeira.  
 ☒ 40 x 150 x 17 mm  
 ⚡ LSR — 60 x 15 mm



**Barley** — 94118

Abridor de garrafas em alumínio.

☒ 39 x 83 x 4 mm  
 ⚡ LSR — 30 x 10 mm



**Malte** — 94115

Abridor de garrafas com imã.

☒ 50 x 105 x 5 mm  
 ⚡ PDP — 40 x 20 mm





**Inox Malbec — 94117**

Saca-rolhas em metal e PP com abridor de garrafas e canivete de sommelier. Espiral em aço inox.

☞ 121 x 20 x 12 mm

☞ PDP – 30 x 5 mm



**Tanat — 94103**

Saca-rolhas em metal com abridor de garrafas e canivete de sommelier.

☞ 110 x 25 x 10 mm

☞ LSR – 70 x 7 mm



**Carin — 94114**

Saca-rolhas em madeira com abridor de garrafas e canivete de sommelier.

☞ 109 x 25 x 8 mm

☞ LSR – 50 x 7 mm

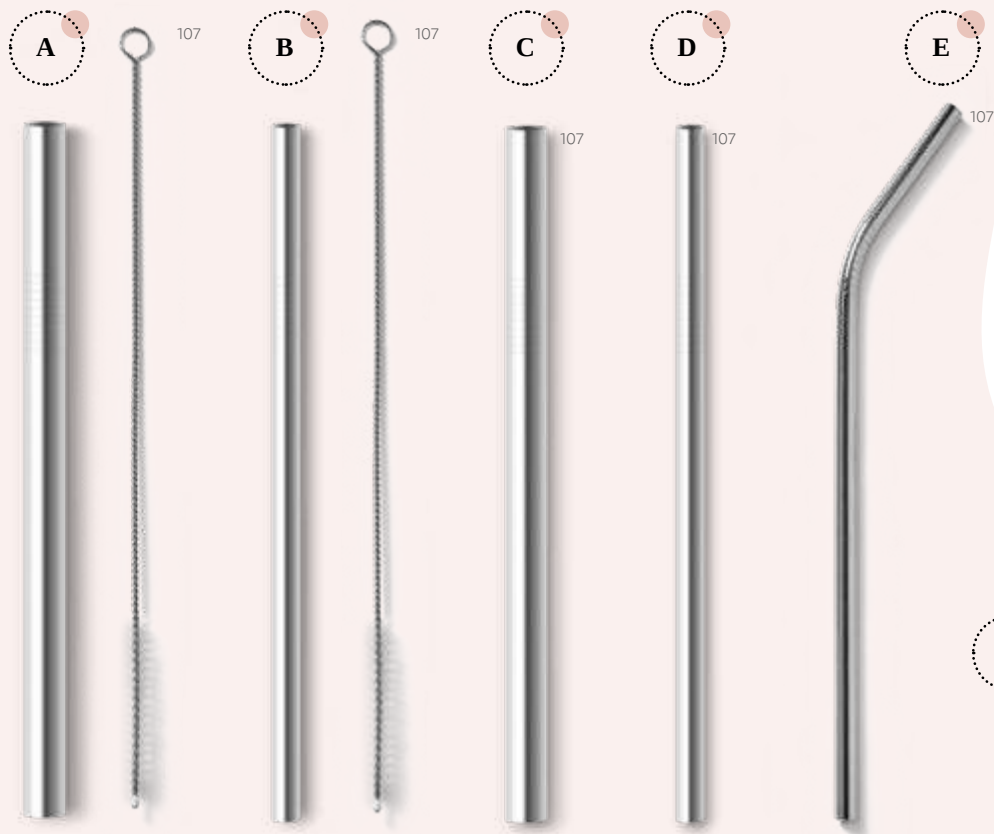



## Mais responsabilidade

Ao optar por canudos reutilizáveis, está a manter os nossos oceanos mais limpos e a contribuir para um planeta mais sustentável.

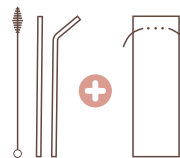
**Combine os canudos reutilizáveis com as bolsas 92918 + 92917**



**A**  **Kahana Wide** — 94095  

Canudo em aço inox. Food grade. Embalagem vendida opcionalmente: 92918 (bolsa em now-woven) ou 92917 (bolsa em linho).

☿ Canudo: Ø8 x 215 mm | Escova de limpeza: 240 mm  
⚡ LSR – 60 x 5 mm

**B**  **Kahana** — 94096  

Canudo em aço inox. Food grade. Embalagem vendida opcionalmente: 92918 (bolsa em now-woven) ou 92917 (bolsa em linho).

☿ Canudo: Ø6 x 215 mm | Escova de limpeza: 240 mm  
⚡ LSR – 60 x 3,5 mm

**C**  **Aerial Wide** — 94094  



Canudo em aço inox. Food grade. Embalagem vendida opcionalmente: 92918 (bolsa em now-woven) ou 92917 (bolsa em linho).

☿ Ø6 x 215 mm  
⚡ LSR – 60 x 5 mm

**D**  **Aerial** — 94092  

Canudo em aço inox. Food grade. Embalagem vendida opcionalmente: 92918 (bolsa em now-woven) ou 92917 (bolsa em linho).

☿ Ø6 x 215 mm  
⚡ LSR – 60 x 3,5 mm

**E**  **Quiver** — 94093  

Canudo em aço inox. Food grade. Embalagem vendida opcionalmente: 92918 (bolsa em now-woven) ou 92917 (bolsa em linho).

☿ Ø6 x 215 mm  
⚡ LSR – 60 x 3,5 mm



Canudo dobrável em silicone



Canudo dobrável em silicone

**NEW**  
 **Julep** — 94090

Canudo reutilizável e dobrável em 100% silicone. O canudo é acompanhado de uma caixa PP translúcida com acabamento fosco permitindo a sua portabilidade.

☿ Palhinha: Ø7 x 250 mm | Caixa: Ø55 x 20 mm  
⚡ PDP – Ø30 mm

**NEW**  
**Drinky** — 94091

Canudo reutilizável e dobrável em 100% silicone. O canudo é acompanhado de uma caixa PP branca e translúcida com acabamento fosco.

☿ Canudo: Ø7 x 250 mm | Caixa: Ø55 x 20 mm  
⚡ PDP – Ø25 mm



A



107

A

NEW

Inox **Bramble** — 94043

Set de cocktail com 6 peças em aço inoxidável: um shaker (600 + 450 ml), um copo dosador (30 ml), uma colher, um pilão e um coador. Inclui uma bolsa em non-woven. Fornecido em caixa presente.

Caixa: 98 x 98 x 290 mm

LSR – 225 x 30 mm

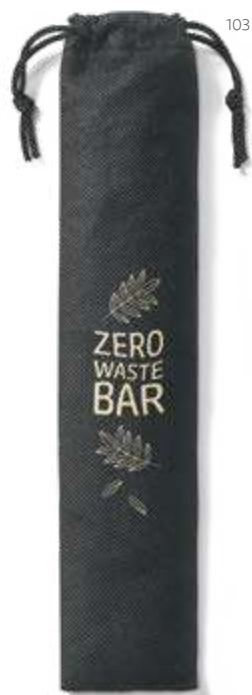

103

**Kitan** — 92918

Bolsa pequena em non-woven.

Caixa: 60 x 265 mm

LSR – 160 x 30 mm



150

**Charon** — 92917

Bolsa pequena em linho.

Caixa: 60 x 265 mm

LSR – 160 x 30 mm



Palhinha telescópico

Inox **Zamba** — 94057

Conjunto de canudo em aço inox e escova de limpeza. Fornecido em estojo com mosquetão. Food grade.

Canudo: Ø9 x 218 mm | Estojo: Ø10 x 105 mm

SCR – 55 x 40 mm





**Lamone** — 94098

Conjunto de 10 canudos de uso único em papel craft. Fornecidos em caixa de papel craft.

Canudo: Ø6 x 196 mm | Caixa: 33 x 200 x 14 mm

SCR – 20 x 90 mm



**Suya** — 94077

Conjunto de talheres descartáveis em madeira composto por: garfo, faca e colher. Incluso guardanapo em craft. Fornecido em bolsa de papel craft.

62 x 216 mm

STI – 45 x 60 mm

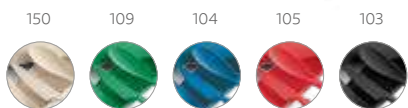

**Tahini** — 94055

Conjunto de 3 talheres em fibra de bambu (50%) e PP (50%) com garfo, faca e colher. Incluso estojo.

Food grade.

205 x 65 x 25 mm

PDP – 60 x 25 mm

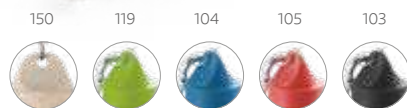

**Lynne** — 94056

Conjunto de canudo em fibra de bambu e escova de limpeza. Fornecido em estojo com mosquetão. Food grade.

Canudo: Ø8 x 225 mm | Estojo: Ø13 x 124 mm

SCR – 55 x 40 mm



**Valley** — 94068

.350





# Marmitas ajustáveis

Aumente ou diminua o tamanho da sua marmita e organize as porções de alimentos de acordo com a sua necessidade.



114

2 compartimentos



+750 ml



**Dill** — 93848

Marmita hermética retrátil em silicone e PP com dois compartimentos com capacidades até 480 ml e 760 ml. No topo da tampa tem um encaixe com um talher (incluso) com função 2 em 1, garfo e colher.

Apta para microondas (retirar a tampa). Food grade.

175 x 212 x 153 x 73 mm | Dobrada: 212 x 153 x 38 mm

PDP - 50 x 20 mm



119

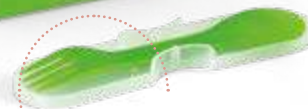

Talher 2 em 1, garfo e colher



119

123



114

132



105



+600 ml



**Saffron** — 93847

Marmita hermética retrátil em silicone e PP com um compartimento com capacidade até 640 ml. No topo da tampa tem um encaixe com um talher (incluso) com função 2 em 1, garfo e colher. Apta para microondas (retirar a tampa). Food grade.

170 x 110 x 66 mm | Dobrada: 170 x 110 x 40 mm

PDP - 50 x 20 mm



114

114



106



119



A

1,2 l



**Cilantro** — 93854

Marmita em PP com 3 compartimentos e capacidade até 1.200 ml. Apta para microondas (retirar a tampa). Incluso garfo, faca e molheira. Food grade.

175 x 175 x 87 mm

PDP - 50 x 25 mm





# Recipiente térmico para comida com dupla parede



**B**

Alça para transporte em silicone



NEW

**B**



**Samoura** — 93851

Recipiente térmico em PP com parede dupla. Com pega para transporte em silicone, ideal para refeições. Food grade. Capacidade até 380 ml

380 ml

∓ 90 x 105 mm  
PDP - Ø40 mm



**C**



Combine esta marmitta com nossa caixa de oferta



**C**



**Bocuse** — 93853

+ 93852 .358

Marmitta em PP e PS com 2 compartimentos (680 ml cada) e 1 divisória removível. Incluso 3 talheres: garfo, faca e colher. Fecha com banda elástica e está apta para microondas (retirar a tampa). Food grade. Caixa branca 93852 vendida opcionalmente.

+650 ml

∓ 180 x 100 x 100 mm  
SCR - 140 x 60 mm



Quadrado liso para personalização

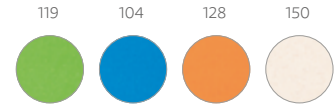

- Lippia** — 94780
- Tábua de corte em fibra de bambu (50%) e PP (50%). Contém um quadrado liso no fundo da tábua, adequado para a personalização. Food grade.
  - 237 x 140 x 4 mm
  - HTS - 35 x 35 mm



- Tokev** — 93870
- Cortador de pizza com abridor de garrafas. Food grade.
  - 132 x 63 x 8 mm
  - PDP - 35 x 25 mm



- Tarragon** — 93899
- 800 ml
  - Marmita em PP com capacidade até 800 ml. Apta para microondas. Food grade.
  - 180 x 125 x 58 mm
  - SCR - 100 x 100 mm



## Apropriado para comida

Procure este símbolo nos nossos produtos apropriados para contato com alimentos



850 ml



**Turmeric** — 53878

+ 94659 358

Copo para salada em PP com garfo e molheira. Capacidade até 850 ml. Apto para microondas (retirar a tampa). Food grade. Caixa branca 94659 vendida opcionalmente.

∅110 x 190 mm

PDP - 30 x 20 mm

Inclui garfo e molheira





103



103

160



NEW

ecologic



**Zimbro** — 99812

Avental com algodão reciclado (140 g/m<sup>2</sup>) e bolso frontal.

☒ 590 x 900 mm | Bolso: 250 x 200 mm

🔪 TRS – 200 x 240 mm



106

103

104

**Chives** — 99822

Avental em algodão e poliéster (150 g/m<sup>2</sup>) com fitas de ajuste e com 2 bolsos frontais.

☒ 650 x 900 mm |

Bolso int.: 80 x 140 mm |

Bolso ext.: 250 x 160 mm

🔪 TXP – 200 x 200 mm



106



103



104

105

106

103

**Ginger** — 99830

Avental em algodão e poliéster (150 g/m<sup>2</sup>) com 2 bolsos frontais. Ajustável com fivela.

☒ 650 x 850 mm |

Bolso: 170 x 180 mm

🔪 TXP – 200 x 230 mm

**Naecker** — 99824

Avental de bar em algodão e poliéster (145 g/m<sup>2</sup>), com 2 bolsos.

☒ 960 x 800 mm |

Bolso: 145 x 200 mm

🔪 TRS – 280 x 130 mm



Tira lateral para suporte de pano de cozinha



NEW

ecologic

**Bosi** — 99814

Avental em 100% algodão canvas (320 g/m<sup>2</sup>) com detalhes em metal. Com 3 bolsos multifuncionais e uma tira lateral (para suporte de um pano de cozinha). Tira do pescoço facilmente ajustável.

▮ 680 x 900 mm

➤ TRS – 200 x 200 mm



150



## Avental 100% algodão com design elegante e funcional



Com 3 bolsos multifuncionais e uma tira lateral para suporte de pano de cozinha

Tira do pescoço facilmente ajustável



NEW

ecologic

**Sunflower** — 99813

Avental em 100% algodão canvas (300 g/m<sup>2</sup>) com detalhes em metal. Com 3 bolsos multifuncionais e uma tira lateral (para suporte de um pano de cozinha). Tira do pescoço facilmente ajustável.

▮ 680 x 900 mm

➤ TRS – 200 x 200 mm



104

103



104



B



NEW

ECologic

**Chicory** — 99835

Avental multiusos em lona de algodão (260 g/m<sup>2</sup>) com 3 bolsos frontais e fita para amarrar à cintura.

☒ 580 x 375 mm

✂ TRS – 140 x 90 mm





## Descubra um novo passatempo

A jardinagem pode ser uma ótima opção para passar mais tempo no exterior e relaxar a mente



NEW

ecologic

 **Orchid** — 98129

Conjunto de jardinagem com 3 ferramentas em metal e madeira de eucalipto: pá, rastelo e garfo. Inclui bolsa 100% algodão (180 g/m<sup>2</sup>) com fita para fechar. Fornecido desmontado.

☿ Bolsa: 130 x 600 mm | Pá: 60 x 254 mm | Ancinho: 63 x 215 mm | Forquilha: 57 x 245 mm

🔪 TRS – 280 x 200 mm



Manta reversível



### Heiden — 99078

Manta reversível em tecido polar 190 g/m<sup>2</sup> acetinado com forro sherpa (225 g/m<sup>2</sup>), para um maior conforto. Inclui na parte do forro um zíper para permitir facilmente a impressão. É fornecida com uma fita em cetim com velcro e um cartão personalizável.

▮ Manta: 1500 x 1200 mm | Fita de cetim : 750 x 40 mm | Cartão: 160 x 130 mm

➤ SCR – 100 x 100 mm



Tratamento antiborboto



### Dyleaf — 99075

Manta em tecido polar (240 g/m<sup>2</sup>) com acabamento aveludado e tratamento anti-pilling. Inclui uma fita acetinada e cartão para personalização.

▮ 1500 x 1200 mm | Cartão: 160 x 130 mm

➤ SCR – 100 x 100 mm



Cartão personalizável

### Warmy — 99071

Manta em tecido polar (250 g/m<sup>2</sup>), com fita acetinada e cartão para personalização.

▮ 1600 x 1300 mm | Cartão: 160 x 140 mm

➤ TRS – 280 x 200 mm



### Sulena — 99051

Manta em tecido polar (180 g/m<sup>2</sup>), disponível em várias cores.

▮ 1450 x 950 mm

➤ TRS – 200 x 280 mm





**Sacolas &  
Bolsas Térmicas**







Bolso interior

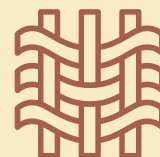

## Juco: o novo tecido ecológico

A combinação entre o algodão e a juta resulta num material de alta durabilidade e resistência: o Juco. Um tecido sustentável, versátil e cada vez mais presente no nosso dia a dia.



**Marbella**  
92938

 .197



NEW

**EcoLogic**



**Padova** — 92937

Sacola em juco (275 g/m<sup>2</sup>) com bolso interior 100% algodão (120 g/m<sup>2</sup>) com fecho e alças de 60 cm. Pegas em webbing de algodão bicolor.

☒ 370 x 410 x 90 mm

✂ TRS - 140 x 45 mm



## Juta e algodão



**ECologic**



**Sablón** — 92919

Sacola tipo mochila 100% algodão (160 g/m<sup>2</sup>) com detalhe em imitação de juta e alça em algodão.

☒ 370 x 410 mm

✂ TXP – 240 x 200 mm



**ECologic**



**Mercat** — 92882

Sacola 100% algodão (160 g/m<sup>2</sup>) com detalhe em imitação de juta e alças de 65 cm.

☒ 375 x 415 mm

✂ TXP – 270 x 200 mm





**ECologic**



**Tizzy** — 92828

Sacola de compras em juta (360 g/m<sup>2</sup>) com laminado no interior e com alças webbing com 60 cm.

☒ 385 x 445 x 165 mm

➤ TRS – 270 x 200 mm



**D**

**ECologic**



**Braga** — 92823

Sacola em juta (240 g/m<sup>2</sup>) com alças de 65 cm e um bolso frontal 100% algodão (140 g/m<sup>2</sup>).

☒ 370 x 410 x 100 mm |

Bolso: 370 x 270 mm

➤ TXP – 200 x 150 mm



**C**

**ECologic**



**Shanti** — 92827

Sacola de compras em juta (360 g/m<sup>2</sup>) com laminado no interior e com alças curtas acolchoadas.

☒ 430 x 340 x 175 mm

➤ TRS – 230 x 160 mm



## Sacolas 100% algodão

De origem orgânica, esta fibra 100% natural permite a criação de peças autênticas, de qualidade e de grande durabilidade.



**ECologic**

 **Feria** — 92869

Sacola 100% algodão (180 g/m<sup>2</sup>) com alças de 60 cm em cortiça e com bolso interior.

☿ 450 x 400 x 105 mm

🔪 TXP – 270 x 230 mm



150



Dobrável



**ECologic**

**Orleans** — 92922

Sacola dobrável 100% algodão (100 g/m<sup>2</sup>). Fornecida desdobrada.

☿ 370 x 400 mm

🔪 TXP – 250 x 200 mm







Parte da frente em rede



NEW

**ECÓlogic**

**Napoli** — 92935

Sacola 100% algodão (120 g/m<sup>2</sup>) com malha 100% algodão na parte frontal (100 g/m<sup>2</sup>) e cordões em algodão para fechar. Sacola ideal para levar alimentos.

300 x 400 mm

TR5 - 200 x 280 mm



**ECÓlogic**

**Mumbai** — 92927

Sacola 100% algodão (180 g/m<sup>2</sup>) com malha 100% algodão na parte frontal. Alças em webbing com 65 cm. Sacola ideal para compras.

390 x 430 x 80 mm

TR5 - 200 x 50 mm

Parte da frente em rede







Alças de **75** cm



**EcoLogic**

**Bondi** — 92821  
Sacola 100% algodão (140 g/m<sup>2</sup>)  
com alças de 60 cm.  
▮ 375 x 415 mm  
▮ **TXP** – 270 x 260 mm



**EcoLogic**

**Regent** — 92414  
Sacola 100% algodão (100 g/m<sup>2</sup>)  
com alças de 75 cm.  
▮ 370 x 410 mm  
▮ **TXP** – 270 x 250 mm



**EcoLogic**

**Victoria** — 92415  
Sacola 100% algodão (100 g/m<sup>2</sup>)  
com alças de 30 cm.  
▮ 370 x 410 mm  
▮ **TXP** – 270 x 250 mm



**EcoLogic**

**Wharf** — 92902  
Sacola 100% algodão (100 g/m<sup>2</sup>)  
com alças de 75 cm.  
▮ 370 x 410 mm  
▮ **TXP** – 270 x 250 mm



**EcoLogic**

**Kolonaki** — 92826  
Sacola 100% algodão (140 g/m<sup>2</sup>)  
com alças de 60 cm.  
▮ 375 x 415 mm  
▮ **TXP** – 270 x 230 mm





150

**ECÓlogic**

**Marvay** — 92825

Sacola 100% algodão (180 g/m<sup>2</sup>) com alças de 65 cm.

▮ 460 x 400 x 105 mm

▮ TXP – 270 x 220 mm



Bolso interior com fecho

**ECÓlogic**

**Hackney** — 92926

Sacola 100% algodão (280 g/m<sup>2</sup>) com fecho e bolso interior. Alças em algodão webbing com 65 cm.

▮ Sacola: 480 x 400 x 150 mm | Bolso interior: 180 x 140 mm

▮ TRS – 280 x 200 mm



150



A

Bolso interior



150

A

**ECÓlogic**

**Beto** — 92820

Sacola 100% algodão canvas (280 g/m<sup>2</sup>) com bolso interior e alças de 65 cm.

▮ 450 x 380 x 105 mm

▮ TXP – 270 x 230 mm



# Sacolas 100% algodão



109  
Fecho magnético



**ECologic**

**Ville** — 92824

Sacola 100% algodão canvas (280 g/m<sup>2</sup>) com bolso frontal e bolso interior com zíper. A sacola contém fecho magnético e alças de 60 cm.

▮ 530 x 380 x 170 mm

▮ TRS - 120 x 150 mm

Bolso interior



**ECologic**

**Edmonton** — 92822

Sacola 100% algodão canvas (280 g/m<sup>2</sup>) com bolso interior e alças de 65 cm.

▮ 460 x 400 x 150 mm

▮ TXP - 260 x 200 mm

Bolso interior



**ECologic**

**Bazar** — 92879

Sacola 100% algodão (140 g/m<sup>2</sup>) com alças de 65 cm.

▮ 370 x 410 x 100 mm

▮ TXP - 270 x 240 mm







**ecologic**

**Hanover** — 92456

Sacola tipo mochila 100% algodão (103 g/m<sup>2</sup>).

☒ 370 x 410 mm

🔪 TXP – 270 x 250 mm

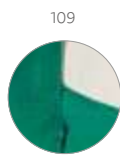

109

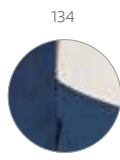

134

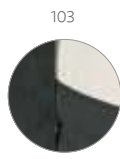

103



**ecologic**

**Romford** — 92913

Sacola tipo mochila 100% algodão (180 g/m<sup>2</sup>).

☒ 350 x 430 mm

🔪 TXP – 240 x 200 mm



103



106



105



114

**ecologic**

**Ilford** — 92914

Sacola tipo mochila 100% algodão.

☒ 370 x 410 mm

🔪 TXP – 270 x 230 mm



## Algodão orgânico

Algodão proveniente de um cultivo sustentável, sem produtos químicos ou pesticidas.



**ECologic**



**Nampula** — 92933

Sacola tipo mochila 100% algodão orgânico (120 g/m<sup>2</sup>) proveniente de um cultivo sustentável, sem químicos ou pesticidas e etiqueta Label Organic.

370 x 410 mm

TR5 – 280 x 200 mm



**ECologic**



**Matola** — 92932

Sacola 100% algodão orgânico (120 g/m<sup>2</sup>) proveniente de um cultivo sustentável, sem químicos ou pesticidas. Alças de 60 cm e etiqueta Label Organic.

370 x 410 mm

TR5 – 280 x 200 mm



Sacola mochila  
2 em 1



NEW

ECologic

**Rissani** — 92936

Sacola tipo mochila com algodão reciclado (140 g/m<sup>2</sup>), alças de 30 cm e cordões em algodão para fechar.

☒ 370 x 410 mm

✂ TRS – 280 x 200 mm



## Algodão reciclado

Uma ótima opção para reduzir o desperdício de têxteis e reaproveitar peças de roupa que já não usamos.



ECologic

**Rynek** — 92920

Sacola em algodão reciclado (140 g/m<sup>2</sup>) com alças de 65 cm.

☒ 375 x 415 mm

✂ TXP – 270 x 230 mm



ECologic

**Chancery** — 92928

Sacola tipo mochila em algodão reciclado (140 g/m<sup>2</sup>), com bolso frontal com fecho discreto e alças em algodão.

☒ 370 x 410 mm

✂ TRS – 280 x 200 mm

Bolso frontal com fecho discreto







## PET Reciclado

Os fios criados a partir de rPET são uma ótima opção para tecer peças amigas do ambiente. Tal como o algodão reciclado, que permite o reaproveitamento de roupas velhas.



NEW

ecologic



Cairo — 92084

Sacola em algodão reciclado e rPET (180 g/m<sup>2</sup>) com alças de 65 cm.

380 x 420 mm

TXP – 300 x 300 mm



## Sacolas de algodão reciclado

O algodão é um material orgânico proveniente de um cultivo sustentável, sem químicos ou pesticidas que permite tecer peças de qualidade, autênticas e de grande durabilidade.

NEW

EcoLogic



**Mexico** — 92323

Sacola em algodão reciclado e poliéster (140 g/m<sup>2</sup>) com alças de 65 cm.

☒ 380 x 429 mm

☒ TXP - 300 x 300 mm



Feito de material reciclado



Feito de material reciclado



NEW

EcoLogic



**Istanbul** — 92083

Sacola tipo mochila em algodão reciclado e poliéster (140 g/m<sup>2</sup>).

☒ 370 x 410 mm

☒ TXP - 300 x 300 mm



**ecologic**



**Maputo** — 92929

Sacola em rPET 190T. Produzida a partir de plástico reciclado contribuindo para a redução dos resíduos no meio ambiente. Alças de 60 cm.

☒ 380 x 420 mm

☒ TRS – 280 x 200 mm



**ecologic**



**Pemba** — 92931

Sacola tipo mochila em rPET 190T. Produzida a partir de plástico reciclado contribuindo para a redução dos resíduos no meio ambiente. Alças de 40 cm.

☒ 370 x 410 mm

☒ TRS – 280 x 200 mm







## PET Reciclado

Após um processo de reciclagem, que não envolve a extração de petróleo, os fios criados a partir de rPET são trabalhados para tecer peças amigas do ambiente.

Dobrável



106



NEW

ecologic



**Bolzano** — 92934

Sacola dobrável em malha rPET com bolsa em rPET 190T para dobrar a sacola. Ideal para as compras.

☒ 320 x 400 mm

☒ TRS – 50 x 30 mm

Dobrável

119



ecologic



**Beira** — 92930

Sacola dobrável em rPET 190T. Produzida a partir de plástico reciclado contribuindo para a redução dos resíduos no meio ambiente. Alças de 40 cm.

☒ 370 x 420 mm

☒ TRS – 50 x 30 mm





114

Saída para fone de ouvido, fios ou cabos



114

106

108

119

A

**Colmar** — 92912

Sacola tipo mochila em 210D com bolso frontal com zíper e saída para fone de ouvido ou outros fios ou cabos.

☒ 350 x 400 mm

☒ TXP - 200 x 150 mm



A



119



119

114

105

103

**Alicante** — 92911

Sacola tipo mochila em 210D com bolso frontal e saída para fone de ouvido.

☒ 350 x 400 mm

☒ TXP - 140 x 180 mm

Elementos refletores



108



**Bissaya**  
92617

☒ .379



108



128



**Rules** — 92835

Sacola tipo mochila em 210D, com elementos refletores. Produto promocional.

☒ 350 x 400 mm

☒ TXP - 250 x 160 mm



**Boxp** — 92904

Sacola tipo mochila em non-woven (80 m/g<sup>2</sup>).

▮ 370 x 410 mm

▮ TXP — 260 x 260 mm



**Carnaby** — 92910

Sacola tipo mochila em 210D.

▮ 350 x 410 mm

▮ TXP — 230 x 250 mm



Laminação  
brilhante



**Sawgrass** — 92850

Sacola em non-woven laminado (90 g/m<sup>2</sup>) com alças de 50 cm e com laminação brilhante.

☒ 340 x 350 x 80 mm

✂ TXP – 220 x 250 mm

Laminação  
brilhante



**Memphis** — 52856

Sacola em non-woven laminado (120 g/m<sup>2</sup>) com laminação brilhante. Alças em webbing de 60 cm.

☒ 420 x 320 x 150 mm

✂ TXP – 270 x 200 mm



**Woodbury** — 92832

Sacola em non-woven (80 g/m<sup>2</sup>) termo-selado com alças de 55 cm.

☒ 330 x 390 x 80 mm

✂ TXP – 200 x 250 mm



**Dale** — 92916

Sacola non-woven (80 g/m<sup>2</sup>) termo-selado com alças de 50 cm.

☒ 320 x 380 x 90 mm

✂ TXP – 200 x 280 mm

# Ideal para viajar

O saco essencial para levar consigo na sua mala de viagem.



## Arasta — 92924

Sacola em non-woven laminado brilhante (140 g/m<sup>2</sup>) com zíper. A sacola tem encaixe para trolley, fundo reforçado e alças em webbing de 65 cm.

☒ 350 x 350 x 200 mm

☒ TXP - 250 x 200 mm

Encaixe para trolley



## Beacon — 92905

Sacola em non-woven (80 g/m<sup>2</sup>) termo-selado com alças de 55 cm.

☒ 480 x 380 x 85 mm

☒ TXP - 270 x 230 mm



## Arleta — 92859

Sacola de compras em non-woven laminado (110 g/m<sup>2</sup>) com bolso frontal (175 g/m<sup>2</sup>).

☒ 381 x 330 x 200 mm

☒ TXP - 130 x 100 mm

Bolso frontal

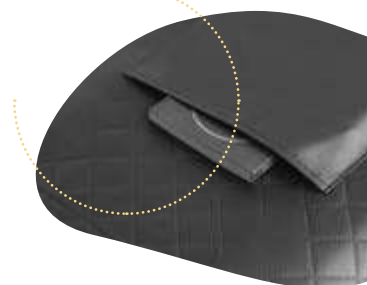



102



**Canary** — 92839

Sacola em non-woven (80 g/m<sup>2</sup>) termo-selado com alças de 75 cm.

☒ 380 x 415 x 85 mm

✂ TXP – 270 x 230 mm



124



**Macy** — 92854

Sacola em non-woven (80 g/m<sup>2</sup>) termo-selado com alças de 55 cm.

☒ 270 x 350 mm

✂ TXP – 160 x 220 mm



108

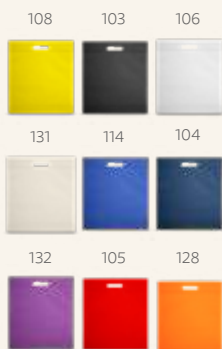

**Stratford** — 92499

Sacola em non-woven (80 g/m<sup>2</sup>) termo-selado.

☒ 355 x 390 x 85 mm

✂ TXP – 260 x 260 mm



119



**Rotterdam** — 92845

Sacola em non-woven (80 g/m<sup>2</sup>) termo-selado.

☒ 250 x 350 x 80 mm

✂ TXP – 160 x 200 mm



# Sacolas dobráveis

Ideais para trazer consigo na mala, ir às compras ou transportar algo de última hora.



## Bilbao — 92848

Sacola à tiracolo dobrável em 190T e alças de 75 cm. Fornecida dobrada.

☒ Dobrado: 105 x 105 mm | Aberto: 360 x 415 x 80 mm

✂ TXP – 150 x 200 mm



## Covent — 92847

Sacola dobrável em non-woven (80 g/m<sup>2</sup>) com alças de 50 cm. Fornecida desdobrada.

☒ Dobrado: 110 x 132 x 20 mm |

Aberto: 360 x 410 x 80 mm

✂ TXP – 200 x 150 mm



## Sacola térmica



## Mayfair — 98423

Sacola térmica dobrável em 210D com alças em webbing de 60 cm, zíper e capacidade até 16 L. Fornecida desdobrada.

☒ 400 x 440 x 130 mm

✂ TXP – 130 x 100 mm



## Pertina — 92998

Sacola dobrável em non-woven (80 g/m<sup>2</sup>) com alças de 65 cm. Fornecida desdobrada.

☒ Dobrado: 200 x 120 mm |

Aberto: 400 x 450 x 200 mm

✂ TXP – 270 x 230 mm



105

105



103



104



104

104



103



105

**Melville** — 98415

Bolsa térmica em 600D com zíper duplo, alça ajustável em webbing e bolso frontal. A bolsa tem capacidade até 12 L. Food grade.

☒ 290 x 340 x 190 mm

☒ TRS – 200 x 100 mm

**Luton** — 98414

Bolsa térmica em 600D com alça ajustável em webbing, bolso frontal e capacidade até 8 L. Food grade.

☒ 270 x 200 x 160 mm

☒ TRS – 200 x 55 mm



104



104



119



103

**Lolla** — 98417

Sacola térmica em 600D com zíper e compartimento exterior aberto forrado que contém um bolso frontal. Ideal para levar para a praia. Alças em webbing com 55 cm e capacidade até 9 L. Food grade.

☒ 470 x 305 x 120 mm

☒ TRS – 170 x 120 mm





## Sacolas térmicas



A



109



109

104

103

A



### Philadel — 98420

Sacola térmica em 600D com 2 formas distintas de utilização. Compartimento principal com zíper duplo e interior forrado em PEVA e almofadado. Contém bolso frontal com zíper e alças ajustáveis em webbing com reforço. A sacola tem capacidade até 15 L.

☒ 480 x 330 x 180 mm | 310 x 240 x 180 mm

➤ TRS – 150 x 45 mm

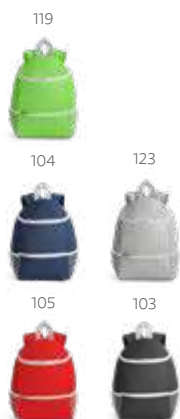

119

104

123

105

103



119



### Jaipur — 98408

Mochila térmica em 600D com capacidade até 10 L. Inclui um bolso frontal com zíper e dois bolsos laterais em tela. Food grade.

☒ 280 x 340 x 140 mm

➤ TRS – 150 x 90 mm



106



106

114

105

119

103



### Singapore — 98418

Bolsa térmica em 600D com alça ajustável em webbing, bolso frontal e capacidade até 9 L. Food grade.

☒ 240 x 220 x 170 mm

➤ TRS – 140 x 100 mm



## Práticas & Versáteis

Seja para a praia ou para um piquenique, as sacolas térmicas flexíveis são uma grande ajuda para levar tudo o que necessita, enquanto mantém os alimentos frescos.



A



104

A



104



109



106



**Baskit** — 98426

Sacola térmica flexível em 600D com zíper duplo e interior forrado. Estrutura removível em alumínio, com pega ergonômica em EVA. Capacidade até 14 L.

∅ 460 x 270 x 250 mm

TRRS – 260 x 150 mm



116



116



104



113

B



**Coast** — 98425

Sacola térmica flexível em 600D com zíper duplo, interior forrado com PEVA e abridor de garrafas. Bolso superior com zíper, alças em webbing, com reforço e capacidade até 15 L. Food grade.

∅ 300 x 260 mm

TRRS – 90 x 80 mm



B



NEW

ECologic

C



**Repurpose Cooler** — 98427



Bolsa térmica em rPET 600D com interior em PEVA.



Alça ajustável em webbing, bolso frontal e fecho duplo.

Capacidade até 7 L.

↕ 240 x 170 x 170 mm

↗ TRS – 140 x 60 mm



**Repurpose Backpack** — 92080

📦 .174



**Repurpose Sports** — 92079

📦 .174



**Repurpose Bag** — 92078

📦 .205

• Fecho com velcro



160

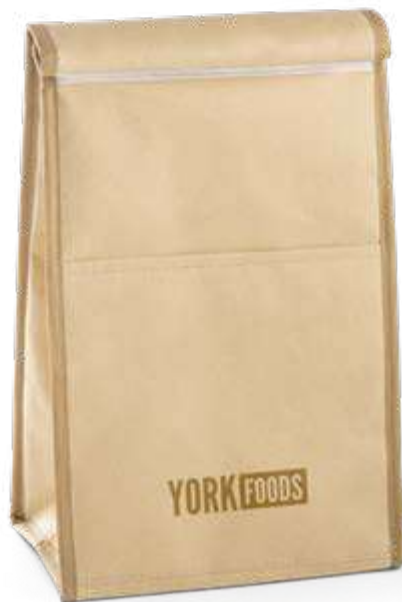

D

NEW



**York** — 98428



Bolsa térmica até 4 L em papel com forro em non-woven e interior com isolamento térmico em alumínio. Fecho com velcro e bolso frontal.

↕ Fechado: 195 x 350 x 110 mm | Aberto: 195 x 410 x 110 mm

↗ TRS – 130 x 130 mm



D





119



**Rotterdam** — 98410

Sacola térmica em non-woven (80 g/m<sup>2</sup>) com fechamento em velcro e bolso frontal. Capacidade até 10 L. Food grade.

☒ 320 x 350 x 170 mm  
☒ TRS – 120 x 150 mm



103



**Jeddah** — 98406

Bolsa térmica em 600D para 6 latas de 0.33 (capacidade até 3 L). Food grade.

☒ 200 x 140 x 125 mm  
☒ TRS – 140 x 90 mm



106



**Medan** — 98411

Bolsa térmica em 600D com capacidade até 4 L. Food grade.

☒ 150 x 190 x 150 mm  
☒ TRS – 90 x 90 mm



104



**Osaka** — 98413

Bolsa térmica dobrável em non-woven (80 g/m<sup>2</sup>) com fecho em velcro e com capacidade até 3 L. Food grade. Bolsa fornecida desdobrada.

☒ Dobrada: 170 x 95 x 40 mm |  
Aberta: 170 x 265 x 110 mm  
☒ TRS – 130 x 35 mm



108



**Izmir** — 98409

Bolsa térmica em non-woven (80 g/m<sup>2</sup>) com capacidade até 3L. Food grade.

☒ 200 x 140 x 130 mm  
☒ TRS – 140 x 90 mm



**Sebastian**

98416

☒ .381



**Turtle** —

58412

☒ .381





## Squeezes, Copos & Esporte



## Materiais duráveis e sustentáveis

O modo como transportamos nossa bebida também pode ser mais sustentável. Materiais como o bambu conferem resistência e originalidade, tornando cada Squeeze único.







Parede dupla isolada a vácuo



Com infusor



103



160



NEW

A

ecologic



**Laver** — 94257

Squeeze em bambu e aço inox com corpo duplo, isolamento a vácuo e tampa em PP. Capacidade até 440 ml. Food grade. Fornecido em caixa presente de papel craft.

∅70 x 222 mm

Inox LSR – 25 x 140 mm



NEW

B

ecologic



**Sow** — 94239

Squeeze em bambu e aço inox, com corpo duplo e isolamento a vácuo. Capacidade até 440 ml. Food grade. Fornecido em caixa presente de papel craft.

∅70 x 215 mm

Inox LSR – 25 x 140 mm





A

Ecuador 250  
94766  
0.323

B



NEW

ecologic



**Pietro** — 94241



Copo de viagem em bambu e aço inox, com sistema de abertura deslizante e parede dupla de isolamento. Capacidade até 500 ml. Food grade. Fornecido em caixa presente de papel craft.



Inox  $\pm$  Ø82 x 158 mm

LSR – 25 x 110 mm

• Tampa deslizante



NEW

ecologic



**Lycka** — 94761



Copo de bambu e aço inox de parede dupla isolada a ar e tampa AS com fecho deslizante. Capacidade até 350 ml. Food grade. Fornecido em caixa presente de papel craft.



$\pm$  Ø80 x 108 mm

Inox  $\nearrow$  DUV – 15 x 60 mm



• 2 infusores em aço inox



ecologic



**Makarova** — 94765



Squeeze em vidro de borossilicato com parede dupla e tampa em bambu. Incluso 2 infusores em aço inox. Capacidade até 490 ml. Apto para ir a máquina de lavar, removendo a tampa. Food grade. Fornecido em caixa presente de papel craft.

$\pm$  Ø72 x 234 mm

LSR – Ø50 mm

• Parede dupla isolada a vácuo



ecologic



**Naturel** — 94683



Squeeze em bambu e aço inox, com parede dupla isolada a vácuo e infusor para chá. Capacidade até 430 ml. Food grade. Fornecida em caixa.

$\pm$  Ø69 x 207 mm | Caixa: 72 x 210 x 72 mm

LSR – 20 x 130 mm







107

600 ml

Prensa francesa



## Torne seus hábitos diários mais sustentáveis

Utilize copos de vidro para beber seu chá ou café da manhã.

NEW



**Jenson** — 94237

Cafeteira em vidro borossilicato e aço inox. Capacidade até 600 ml. Food grade. Fornecida em caixa.

∓ Ø95 x 170 mm

∕ LSR - Ø25 mm



110



NEW



**Lunkina** — 94768

Caneca em vidro com capacidade até 390 ml. Food grade. Fornecida em caixa.

∓ Ø91 x 103 mm

∕ PDP - 25 x 30 mm



106



NEW



**Kenny II** — 93804

Caneca em vidro com efeito fosco com capacidade até 340 ml. Fornecida em caixa.

∓ Ø80 x 97 mm |

Caixa: 120 x 88 x 102 mm

∕ PDP - Ø40 mm



110



NEW



**Americano** — 94785

Copo de vidro isotérmico com parede dupla isolada a ar e capacidade até 220 ml. Food grade. Fornecido em caixa de oferta personalizável.

∓ Ø80 x 86 mm

∕ PDP - 25 x 20 mm



110



NEW



**Espresso** — 93873

Conjunto de café em vidro isotérmico com 2 copos com parede dupla isolada a ar e capacidade até 75 ml. Fornecido em caixa presente personalizável.

∓ Caixa: 133 x 65 x 65 mm

∕ PDP - 25 x 10 mm



Infusor em aço inox

750 ml

160



A

NEW

ECologic



**Snead** — 94238

Bule de vidro borossilicato com tampa em bambu. Inclui infusor em aço inox. Capacidade até 750ml. Food grade. Fornecido em caixa presente de papel craft.

Inox

∅ 200 x 85 mm

LSR - Ø70 mm



B

**Hibiscus**  
93978

∅ .268



**Verbena**  
93977

∅ .268



160



NEW

ECologic

**Ecuador 250** — 94766

Copo de viagem em vidro borossilicato com parede dupla isolada a ar e tampa em bambu. Copo com capacidade até 250 ml, ideal para líquidos frios ou quentes, tendo uma tampa com isolante em silicone que facilita o transporte do copo evitando respingo. Apto para ir ao microondas e à máquina de lavar, retirando a tampa. Food grade. Fornecido em caixa presente de papel craft.

∅ 89 x 91 mm

LSR - Ø60 mm

B



NEW

ECologic

**Ecuador 350** — 94767

Copo de viagem em vidro borossilicato com parede dupla isolada a ar e tampa em bambu. Copo com capacidade até 350 ml, ideal para líquidos frios ou quentes, tendo uma tampa com isolante em silicone que facilita o transporte do copo evitando respingo. Apto para ir ao microondas e à máquina de lavar, retirando a tampa. Food grade. Fornecido em caixa presente de papel craft.

∅ 91 x 119 mm

LSR - Ø60 mm

Isolante em silicone para facilitar o transporte





## Vidro borossilicato

Grande resistência e durabilidade. Ideal quer para altas temperaturas, quer para baixas temperaturas.

500 ml



Acabamento fosco

NEW

EcoLogic

**Lillard** — 94770

- Squeeze de vidro borossilicato fosco com tampa em bambu e capacidade até 500 ml. Food grade.
- Fornecido em caixa presente de papel craft.

∅ 65 x 190 mm

SCR – 120 x 120 mm

600 ml



Apto para bebidas quentes



Apto para bebidas frias

EcoLogic

**Dakar** — 94699

- Squeeze em vidro borossilicato e com tampa em bambu.
- Revestido com luva em silicone. Capacidade até 600 ml.
- Food grade. Fornecido em caixa.

∅ 68 x 231 mm

PDP – 25 x 30 mm





**A**

1L

NEW

**ECologic**



**Jasmin 1000** — 94236

Squeeze em vidro borossilicato com tampa de cortiça. Capacidade até 1L. Food grade. Fornecido em caixa presente de papel craft.

∅83 x 215 mm

LSR - ∅55 mm



**B**

800 ml

NEW

**ECologic**



**Jasmin 800** — 94235

Squeeze em vidro borossilicato com tampa de cortiça. Capacidade até 800 ml. Food grade. Fornecido em caixa presente de papel craft.

∅80 x 190mm

LSR - ∅50 mm



800 ml

**B**



1L

**A**





+ 500 ml



A



ecologic



**Raise** — 94646 + 94651 .358

Squeeze em vidro e aço inox com alça na tampa para facilitar o transporte. Capacidade até 520 ml. Fornecido com luva em soft shell. Food grade. Caixa branca 94651 vendida opcionalmente.

∅ 65 x 225 mm

TR5 - 40 x 120 mm



**B**



**ecologic**

**Dhabi** — 94668

Squeeze em vidro borossilicato com tampa em PP e bolsa em silicone. Capacidade até 380 ml. Food grade. Fornecida em caixa.

∅58 x 191 mm

PDP – 40 x 40 mm



**C**



**ecologic**

**Williams** — 94669

Squeeze em vidro borossilicato com tampa em PP e uma pega em silicone. Capacidade até 470 ml. Food grade. Fornecida em caixa.

∅60 x 210 mm

SCR – 150 x 120 mm



# Os Squeezes e copos ideais para manter a temperatura da sua bebida







Isolamento a vácuo em cobre



Tampa à prova de fugas



NEW

ecologic



**Norre Bottle** — 94662

Squeeze em aço inox com parede dupla isolada a vácuo, parede interna revestida de cobre e tampa em bambu com vedante de silicone para proteção extra. Tem capacidade até 640 ml e mantém as bebidas quentes por 16 h e frias por 48 h. Contém revestimento em pó que lhe confere mais durabilidade e resistência. Food grade. Fornecido em caixa presente de papel craft.



∅ 72 x 233 mm  
LSR – 20 x 140 mm



NEW

ecologic



**Norre Tumbler** — 94661

Copo em aço inox com parede dupla isolada a vácuo, parede interna revestida de cobre e tampa em bambu com vedante de silicone para proteção extra. Tem capacidade até 370 ml e mantém as bebidas quentes por 5 h e frias por 24 h. Contém revestimento em pó que lhe confere mais durabilidade e resistência. Food grade. Fornecido em caixa presente de papel craft.



∅ 80 x 106 mm  
LSR – 30 x 55 mm



Tampa com isolante em silicone

---

## Um toque diferente

Para quem procura uma alternativa moderna e original aos tradicionais Squeezes, o acabamento em borracha irá surpreendê-lo.



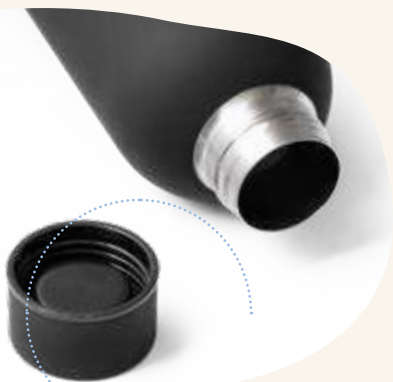

• Tampa à prova de fugas



NEW



Parede dupla isolada a vácuo



**Odin** — 94603

Squeeze em aço inox com acabamento em borracha, parede dupla isolada a vácuo e capacidade até 550 ml. Food grade. Fornecida em caixa de oferta.

∅ 70 x 220 mm  
SCR – 180 x 120 mm



550 ml



Parede dupla isolada a vácuo



**Buffon** — 94078

Squeeze em aço inox com parede dupla e tampa com sistema de vácuo. Capacidade até 530 ml. Food grade. Fornecida em caixa branca.

∅ 67 x 255 mm | Caixa: 75 x 75 x 275 mm  
SCR – 160 x 100 mm



+500 ml



# Parede dupla isolada a vácuo

Responsável por eliminar a condensação e manter a temperatura da bebida. Para além disso, a parte exterior permanece à temperatura ambiente.



NEW



**Show Satin** — 94771

Squeeze em aço inox com parede dupla isolada a vácuo, capacidade até 540 ml e tampa à prova de fugas. Food grade. Fornecida em caixa de oferta branca.

∅71 x 255 mm

SCR – 140 x 80 mm

Parede dupla isolada a vácuo



**Show** — 94550

Squeeze em aço inox com parede dupla e tampa com sistema de vácuo. Capacidade até 510 ml. Food grade. Com caixa branca 94657.

∅67 x 255 mm

SCR – 140 x 80 mm

Tampa com isolante em silicone



Parede dupla isolada a vácuo



A



Parede dupla isolada a vácuo

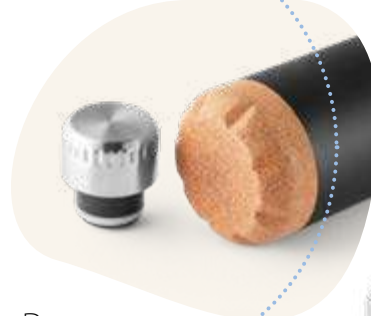

Base de cortiça

+550 ml



A

NEW



**Solberg** — 94240

Squeeze em aço inox e base em cortiça com parede dupla com isolamento a vácuo. Mantém as bebidas quentes por 8h e frias por 24h. Tem capacidade até 560 ml. Food grade. Fornecido em caixa.



∅ 66 x 258 mm  
LSR - 25 x 100 mm



Parede dupla isolada a vácuo



**Amorti** — 94958

Squeeze para sublimação em aço inox com parede dupla e tampa com sistema de vácuo. Capacidade até 510 ml. Food grade. Fornecida em caixa branca 94657.

∅ 67 x 255 mm  
SUB - 140 x 80 mm

360°

Ideal para impressão em sublimação



+500 ml



Leve o seu squeeze preferido para qualquer lado



Personalização a laser



Parede dupla isolada a vácuo



+550 ml

24H  
8H



NEW

 **Ragnar** — 94602

Squeeze em aço inox com parede dupla isolada a vácuo, tampa em bambu e alça de transporte em aço inox. Capacidade até 570 ml. Food grade. Fornecido em caixa presente de papel craft.

∅70 x 220 mm

LSR - ∅40 mm



# Squeezes em alumínio



650 ml



**Korver** — 94631



94657



.358

Squeeze em alumínio e com tampa flip top em AS e alça para facilitar o transporte. Capacidade até 650 ml. Food grade. Caixa branca 94657 vendida opcionalmente.

∅66 x 250 mm

SCR - 200 x 130 mm



500 ml



119



119

114

105

128

137

127

106

147

103

A



**Beane** — 94063

+ 94657 .358

Squeeze em alumínio com tampa em aço inox e capacidade até 500 ml. Food grade. Caixa branca 94657 vendida opcionalmente.

∅67 x 205 mm

LSR - 25 x 80 mm



500 ml



127



106

360°

Ideal para impressão em sublimação



**Billy II** — 54957



Squeeze para sublimação em alumínio com tampa em aço inox. Capacidade até 500 ml. Caixa branca 94657 vendida opcionalmente.



∅67 x 205 mm



Inox SUB - 130 x 80 mm







Acabamento emborrachado

Acabamento matte com glitter



NEW

 **Queta soft** — 94256

 Squeeze em alumínio com acabamento emborrachado e tampa em bambu.  
 Capacidade até 550 ml. Food grade. Caixa branca 94656 vendida opcionalmente.

∅65 x 197 mm

SCR - 135 x 110 mm

NEW

 **Queta** — 94250

 Squeeze de alumínio com acabamento matte e tampa em bambu. Capacidade até 550 ml. Food grade. Caixa branca 94656 vendida opcionalmente.

∅65 x 197 mm

SCR - 135 x 110 mm





105

800 ml



105

104

119

106

103



**Sporty** — 94633



94659



.358



Squeeze em alumínio com acabamento matt, tampa em PP e mosquetão. Capacidade até 800 ml. Food grade. Caixa branca 94659 vendida opcionalmente.



∅73 x 259 mm

SCR - 220 x 140 mm



114

750 ml



114

106

127

147



**Siderot** — 94688



94657



.358



Squeeze em alumínio com mosquetão e capacidade até 750 ml. Food grade. Caixa branca 94657 vendida opcionalmente.

∅73 x 247 mm

SCR - 220 x 140 mm

500 ml



127



106



Ideal para impressão em sublimação



**Langford** — 94960



94656



.358



Squeeze em alumínio para sublimação com mosquetão e capacidade até 500 ml. Food grade. Caixa branca 94656 vendida opcionalmente.

∅66 x 210 mm

SUB - 130 x 80 mm

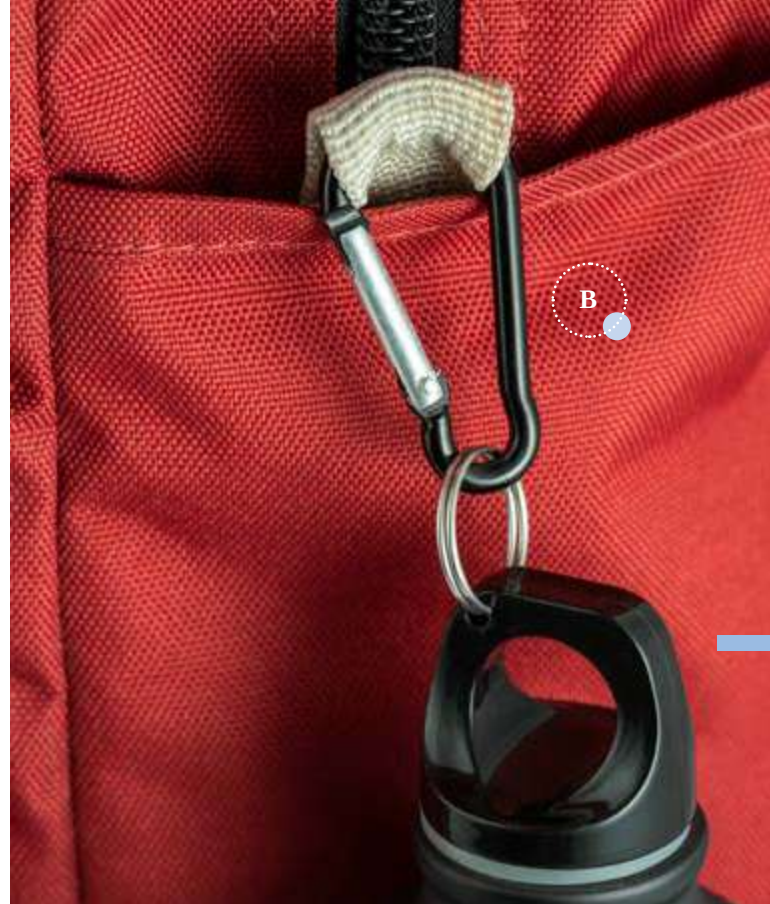

A



500 ml



B



Acabamento mate

550 ml





 **Erald** — 94623 +  94656  .358

 Squeeze em alumínio com mosquetão e capacidade até 500 ml. Food grade. Caixa branca 94656 vendida opcionalmente.

∅66 x 210 mm

SCR - 200 x 110 mm

NEW

 **Collina** — 94246 +  94650  .358

 Squeeze em alumínio com acabamento mate e mosquetão para facilitar o transporte. Capacidade até 550 ml. Food grade. Caixa branca 94650 vendida opcionalmente.

∅66 x 216 mm

SCR - 200 x 110 mm



+ 550 ml

+ 94656 .358



**Kobe** — 94060

Squeeze em alumínio com tira em silicone e capacidade até 570 ml. Food grade. Caixa branca 94656 vendida opcionalmente.

∅ 66 x 205 mm

LSR - 23 x 100 mm



• Canudo flexível no interior



+ 650 ml

+ 94652 .358



**Lemon** — 94649

Squeeze em alumínio com bico de canudo flexível em PP (no interior) e capacidade até 670 ml. Food grade. Caixa branca 94652 vendida opcionalmente.

∅ 73 x 217 mm

LSR - 25 x 120 mm



Forma triangular

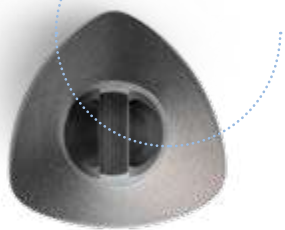

+550 ml

A



**Slater** — 94062

+ 94654 .358

Squeeze em alumínio com formato triangular e tampa em PP. Capacidade até 570 ml. Food grade. Caixa branca 94654 vendida opcionalmente.

∅75 x 158 mm

LSR – 40 x 100 mm



A



106



127



103

+650 ml



**Rio** — 94059

+ 94651 .358

Squeeze em alumínio com tampa em PP e tira em silicone para facilitar o transporte. Capacidade até 660 ml. Food grade. Caixa branca 94651 vendida opcionalmente.

∅65 x 228 mm

LSR – 25 x 150 mm





# Garrafa com parede dupla isolada a vácuo e botão de abrir/fechar

500 ml



106



Ideal para sublimação



NEW



**Henderson** — 94264



Garrafa em aço inox com parede dupla, para sublimação. Tampa com sistema de vácuo. Capacidade até 500ml. Mantém as bebidas quentes por 12h e frias por 24h.



Food grade. Fornecida em caixa.



∅ 70 x 245 mm

LSR - 210 x 175 mm



500 ml



107



NEW



**Karpov** — 94610



Garrafa em aço inox com parede dupla isolada a vácuo. Capacidade até 500 ml.



Fornecida em caixa.



∅ 69 x 240 mm



LSR - 25 x 150 mm



500 ml



105



104



106



103



NEW



**Luka** — 94615



Garrafa em aço inox com parede dupla isolada a vácuo. Capacidade até 500 ml.



Food grade. Fornecida em caixa branca.



∅ 70 x 245 mm



LSR - 25 x 150 mm





• Parede dupla isolada a vácuo

• Parede dupla isolada a vácuo



147

• Inclui **2** copos



750 ml

NEW



**Heat** — 94667



Garrafa em aço inox com parede dupla isolada a vácuo. Capacidade até 750 ml.



Inclui 2 copos. Food grade. Fornecida em caixa.

∓ Ø86 x 310 mm

∓ LSR - 30 x 100 mm



107



1L

NEW



**Liter** — 94679



Garrafa em aço inox com parede dupla isolada a vácuo. Capacidade até 1L. Food grade. Fornecida em caixa.



Inclui 2 copos. Food grade. Fornecida em caixa.

∓ Ø82 x 330 mm

∓ LSR - 30 x 150 mm



---

## Squeeze com termômetro

Permite um maior controle  
de temperatura da sua bebida,  
deixando-a ao seu gosto.





• Parede dupla isolada a vácuo

106

127

103

happy

• Tampa com termómetro digital



NEW

**Rossi** — 94069

Squeeze em aço inox com parede dupla isolada a vácuo e tampa com termómetro digital.

Inclui infusor para chá. Mantém as bebidas quentes por 8 h e frias por 24 h e tem capacidade até 470 ml. Food grade. Fornecido em caixa.

Inox  
 ∅65 x 229 mm

SCR - 130 x 80 mm



## Copos de viagem com parede dupla isolada a ar



**Ronde** — 94677  
 Copo de viagem em aço inox com corpo duplo e tampa deslizante. Capacidade até 400 ml. Food grade. Fornecida em caixa.  
 Inox  
 88 x 112 mm  
 PDP – 30 x 30 mm



**Hygge** — 94678  
 Copo de viagem com corpo duplo em aço inox e acabamento matt. Capacidade até 400 ml. Food grade. Fornecido em caixa.  
 Inox  
 Ø88 x 112 mm  
 PDP – 30 x 30 mm



Revestimento em pó para  
mais durabilidade

Parede dupla  
isolada a vácuo



NEW

**Phelps** — 94772

Copo de viagem em aço inox e PP com parede dupla e isolamento a vácuo. Acabamento mate e revestimento em pó que lhe confere mais durabilidade e resistência. Tem capacidade até 470ml. Fornecido em caixa.

∅90 mm x 150 mm

LSR - 15 x 50 mm



**Ideal para impressão  
em sublimação**

Parede dupla  
isolada a vácuo



NEW

**Slider** — 94242

Copo de viagem para sublimação com parede dupla em aço inox.

Inclui tampa transparente com abertura deslizante.

Capacidade até 380ml. Food grade. Fornecido em caixa.

∅77 x 120 mm

SUB - 246 x 120 mm



Abertura  
deslizante



107



NEW



**Himalayas** — 94664

Conjunto de 4 copos em aço inox com bolsa para transporte em imitação de pele e com capacidade até 25 ml. Food grade. Fornecido em caixa de oferta.

∓ Ø44 x 62 mm

↗ LSR – 15 x 20 mm



103

A



**Wings** — 94614

Caneca em aço inox, com pega em forma e função de mosquetão. Capacidade até 230 ml. Food grade. Fornecida em caixa.

∓ Ø70 x 82 mm

↗ LSR – 15 x 70 mm



127



**Noah** — 94608

Caneca de viagem em aço inox e PP com tampa em PP. Capacidade até 420 ml. Food grade. Fornecida em caixa.

∓ Ø80 x 170 mm

↗ PDP – 35 x 30 mm



103



103



**Werner** — 94666

Copo de viagem em PP e PS com corpo duplo e capacidade até 520 ml. Tampa com sistema de abertura e fecho fácil. Corpo removível para personalização do interior. Food grade. Fornecido em caixa.

∓ Ø86 x 168 mm

↗ DGL – 220 x 136 mm



Tampa com sistema antiderrame



**Monarda** — 94681

Copo de viagem em aço inox com corpo duplo, tampa em PP com sistema anti derrame e antidesslizante na base. Capacidade até 470 ml. Food grade. Fornecido em caixa presente preta.

∅80 x 198 mm | Caixa: 82 x 202 x 82 mm

LSR – 30 x 100 mm



**Batum** — 94625

Copo de viagem em aço inox e PP com corpo duplo. Tampa com sistema de abertura e fecho fácil. Capacidade até 420 ml. Food grade. Fornecida em caixa.

∅81 x 187 mm

PDP – 25 x 50 mm

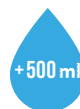

**Hassi** — 94676

Copo de viagem em aço inox e PP com corpo duplo e capacidade até 510 ml. Food grade. Fornecida em caixa presente branca.

∅87 x 151 mm

PDP – 25 x 50 mm





# Copos de fibra de bambu



150



## ECÓlogic



**Toffa** — 94066



Copo de viagem em fibra de bambu e PP com tampa flip top. Capacidade até 380 ml.



Food grade.



∅95 x 113 mm

PDP – 20 x 50 mm



150

## ECÓlogic



**Tisana** — 94636



Copo para viagem em fibra de bambu e PP. Com tampa e capacidade até 450 ml.



Food grade.



∅93 x 134 mm

PDP – 20 x 50 mm



150

## ECÓlogic



**Valley** — 94068



Copo de viagem em fibra de bambu (50%) e PP (50%) com canudo retrátil e capacidade até 450 ml. Pode ocorrer transferência de calor. Food grade.



∅93 x 135 mm

PDP – 20 x 40 mm



114



119

500 ml

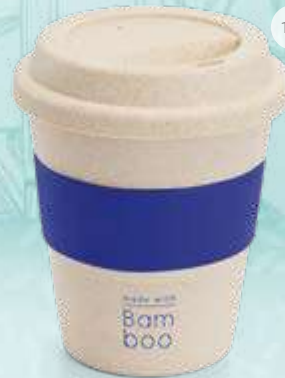

114



114

124

119

105

128

106

103

## ECÓlogic



**Canna** — 94638



Copo de viagem em fibra de bambu (50%) e PP (50%), com tira de silicone no corpo para facilitar o transporte. A tampa em silicone no topo roda para tapar abertura e prevenir salpicos. Capacidade até 500 ml. Food grade.



∅95 x 140 mm

PDP – 20 x 20 mm



114

105

128

109

106

103

## ECÓlogic



**Latte** — 94067



Copo de viagem em fibra de bambu (50%) e PP (50%) com tira em silicone para facilitar o transporte de bebidas quentes. Capacidade até 380 ml. Food grade.



∅95 x 114 mm

PDP – 25 x 25 mm



**eco logic**

**Cuppa** — 94058

Copo de viagem com tampa em fibra de bambu (50%) e PP (50%), com capacidade até 380 ml e tira em silicone para facilitar o transporte de bebidas quentes. Food grade.

∅ 95 x 114 mm  
 PDP – 25 x 20 mm

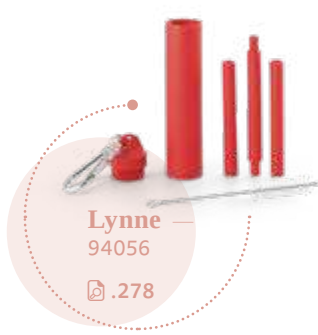

**Lynne** — 94056

.278



**eco logic**

**Bacuri** — 94691

Copo para viagem em fibra de bambu e PP. Com tampa e capacidade até 450 ml. Food grade.

∅ 93 x 134 mm  
 PDP – 20 x 40 mm





## Fibra de arroz

Resultante da transformação da casca de arroz após a colheita, a fibra de arroz permite a criação de produtos leves e resistentes, aproveitando esta matéria natural e biodegradável.



A



Fibra de bambu

**ECologic**



**Cinnamon** — 94626



Copo para viagem em fibra de bambu, casca de arroz e melamina. Com tampa e banda de silicone e capacidade até 450 ml. Food grade.



∅96 x 140 mm



PDP – 25 x 25 mm



Casca de arroz

B



Casca de arroz



**ECologic**



**Petrelli** — 94637



Copo em fibra de arroz (50%) e PP (50%) com acabamento matt.



Capacidade até 400 ml. Food grade.



∅88 x 102 mm



PDP – 20 x 50 mm



# Copos dobráveis

Práticos e fáceis de transportar, aliam a simplicidade à funcionalidade.



105



105

119

124

123

## Orton — 94696

 Copo de viagem dobrável em silicone com tampa em PP. Contém uma argola na base que serve como pega ou para pendurar. Copo com capacidade até 240 ml. Food grade.

∓ Ø57 x 87 x 81 mm

↗ PDP - Ø35 mm



108



108

119

109

114

104

132

142

112

105

## Modric — 94694

 Copo de viagem dobrável em silicone com tampa em PP. Contém uma argola na base que serve como pega ou para pendurar. Copo com capacidade até 240 ml. Food grade.

∓ Ø57 x 87 x 81 mm

↗ PDP - Ø35 mm



124

124



109



123



## Orton L — 94697

 Copo de viagem dobrável em silicone com tampa em PP. Contém uma argola na base que serve como pega ou para pendurar. Copo com capacidade até 400 ml. Food grade.

∓ Ø66 x 117 x 96 mm

↗ PDP - Ø40 mm



114



114

105

104

119

## Modric L — 94695

 Copo de viagem dobrável em silicone com tampa em PP. Contém uma argola na base que serve como pega ou para pendurar. Copo com capacidade até 400 ml. Food grade.

∓ Ø66 x 117 x 96 mm

↗ PDP - Ø40 mm

# tritan™

Plástico super resistente, leve, cristalino e livre de BPA. Suporta altas temperaturas e não absorve cheiros.



tritan™



**Pepe** — 94620



Squeeze em Tritan™ com tampa flip top em PP, compartimento em ABS para cartões, chaves e dinheiro. Capacidade até 800 ml. Food grade. Fornecida em caixa.

∅ 80 x 260 mm

SCR – 70 x 70 mm



tritan™



**Rozier** — 94648

+ 94657 358



Squeeze em Tritan™ com capacidade até 790 ml. Food grade. Caixa branca 94657 vendida opcionalmente.



∅ 71 x 246 mm

SCR – 140 x 140 mm



tritan™



**Dudley** — 94628

+ 94657 358



Squeeze em tritan™ com tampa em PP, canudo flexível (no interior) e com sistema de abertura e fecho fácil. Contém suporte para celular e tem capacidade até 750 ml. Food grade. Caixa branca 94657 vendida opcionalmente.

∅ 75 x 222 mm

SCR – 230 x 120 mm

+750 ml

750 ml



## Squeeze em rPET

Dão uma nova vida ao plástico que poderia ir parar aos oceanos ou demorar anos a deteriorar-se.

Pega em silicone



**Senna** — 94782

+ 94651 358



Squeeze produzido a partir de plástico reciclado, rPET. Com alça de silicone para facilitar o transporte. Tampa em PP e aço inox com isolante em silicone. Capacidade até 590 ml. Food grade. Caixa branca 94651 vendida opcionalmente.



∅66 x 230 mm



SCR – 120 x 100 mm



Bico "push-pull"

600 ml

104

106

104



 **Clouds** — 94632 +  94657  .358

 Squeeze em PS e tampa em ABS com bico "push-pull". Incluso vaporizador, alça para facilitar o transporte e capacidade até 600 ml. Food grade. Caixa branca 94657 vendida opcionalmente.

∅66 x 250 mm

SCR – 200 x 120 mm

+700 ml

106

114



+700 ml

110

Infusor para fruta no interior



 **Othmer** — 94644 +  94658  .358

 Squeeze em AS com tampa em PE, porta comprimidos em PP, com 7 divisórias e capacidade até 740 ml.

 Food grade. Caixa branca 94658 vendida opcionalmente.

∅75 x 240 mm

SCR – 20 x 60 mm

 **Town** — 94629 +  94657  .358

 Squeeze em AS e com tampa flip top em PP com infusor de frutas e capacidade até 740 ml. Food grade. Caixa branca 94657 vendida opcionalmente.

∅70 x 247 mm

SCR – 210 x 130 mm



Base e tampa em aço inox

A



**Ancer** — 94687 + 94670 .358  
 Squeeze em AS e aço inox com capacidade até 700 ml. Food grade. Caixa branca 94670 vendida opcionalmente.  
 Ø74 x 265 mm  
 SCR – 220 x 80 mm



**Serena** — 94618 + 94650 .358  
 Squeeze em AS com tampa em aço inox e capacidade até 600 ml. Food grade. Caixa branca 94650 vendida opcionalmente.  
 Ø71 x 215 mm  
 PDP – 20 x 50 mm

# Torne seus Squeezes e marmitas em presentes inesquecíveis!

Personalize seus Squeezes e marmitas e coloque seu logo numa caixa presente! Disponíveis em 12 tamanhos distintos, para valorizar sua marca!



## **Horus 1** — 94650

Caixa em cartão, indicada para as referências: 94618 e 94246.

☒ 75 x 75 x 225 mm

🔪 SCR – 50 x 170 mm

## **Horus 2** — 94651

Caixa. Cartão. Indicada para as referências 94059; 94061; 94621; 94646 e 94782.

☒ 75 x 75 x 235 mm

🔪 SCR – 50 x 170 mm

## **Horus 3** — 94652

Caixa. Cartão. Indicada para as referências 94622 e 94649.

☒ 80 x 95 x 220 mm

🔪 SCR – 50 x 170 mm

## **Horus 4** — 94653

Caixa em cartão, indicada para as referências: 99967 e 54641

☒ 75 x 75 x 190 mm

🔪 SCR – 50 x 165 mm

## **Horus 5** — 94654

Caixa. Cartão. Indicada para as referências 94062 e 94619.

☒ 95 x 95 x 170 mm

🔪 SCR – 70 x 145 mm

## **Horus 6** — 94655

Caixa em cartão, indicada para a referência: 94646.

☒ 82 x 82 x 233 mm

🔪 SCR – 60 x 180 mm

## **Titus 1** — 94656

Caixa. Cartão. Indicada para as referências 94060; 94250; 94256; 94623; 94686 e 94960.

☒ 70 x 70 x 215 mm

🔪 SCR – 45 x 170 mm

## **Titus 2** — 94657

Caixa. Cartão. Indicada para as referências 54957; 94063; 94550; 94628; 94629; 94630; 94631; 94632; 94648; 94688 e 94958.

☒ 77 x 77 x 257 mm

🔪 SCR – 55 x 180 mm

## **Titus 3** — 94658

Caixa. Cartão. Indicada para a referência 94644.

☒ 82 x 82 x 265 mm

🔪 SCR – 60 x 180 mm

## **Titus 4** — 94659

Caixa. Cartão. Indicada para a referência 94633.

☒ 115 x 115 x 195 mm

🔪 SCR – 85 x 160 mm

## **Titus 5** — 94670

Caixa. Cartão. Indicada para a referência 94687.

☒ 80 x 80 x 275 mm

🔪 SCR – 55 x 220 mm

## **Otao** — 93852

Caixa em cartão, indicada para a referência: 93853.

☒ 190 x 105 x 108 mm

🔪 SCR – 165 x 80 mm





+ 94657 .358



**Portis** — 94630

Squeeze em PP e com tampa em PS e capacidade até 600 ml. Food grade. Caixa branca 94657 vendida opcionalmente.

∅67 x 245 mm

SCR – 200 x 120 mm



600 ml



+ 94652 .358



**Odret** — 94622

Squeeze em AS com tampa em PP com boquilha de canudo flexível (no interior) e de abertura fácil. Capacidade até 650 ml. Food grade. Caixa branca 94652 vendida opcionalmente.

∅73 x 214 mm

SCR – 190 x 55 mm



650 ml

Canudo flexível no interior

Canudo flexível no interior



+ 94651 .358



**Conley** — 94621

Squeeze em PS com tampa em PE com bico de canudo flexível (no interior) e de abertura fácil. Capacidade até 500 ml. Food grade. Caixa branca 94651 vendida opcionalmente.

∅70 x 230 mm

SCR – 190 x 120 mm



500 ml



+ 94651 .358



**Jay** — 94061

Squeeze em AS com tampa em PP. Canudo incluso e capacidade até 610 ml. Food grade. Caixa branca 94651 vendida opcionalmente.

∅70 x 225 mm

SCR – 220 x 120 mm



+ 600 ml



+500 ml



**Launay** — 94686

+ 94656 .358

Squeeze em AS com tampa em PP e capacidade até 510 ml. Food grade. Caixa branca 94656 vendida opcionalmente.

∅68 x 203 mm

SCR – 200 x 80 mm



**Bocuse** —

93853

.281



**Turmeric** —

53878

.283

550 ml



109



106

Com escala de medição



109



106



103



114



105



**Nurmi** — 94619

+ 94654 .358

Shaker em HDPE com tampa flip top em PP. Incluso misturadora em aço inox e escala de medição até 400 ml. Capacidade até 550 ml. Food grade. Caixa branca 94654 vendida opcionalmente.

∅93 x 160 mm

PDP – 25 x 50 mm

# Squeezes dobráveis com mosquetão

com um design flexível e prático que podem acompanhá-lo para qualquer lado.



## **Kwill** — 94612

Squeeze dobrável em PE com bico de sistema “push-pull” e acabamento translúcido. Contém uma tampa transparente e um mosquetão. Capacidade até 460 ml. Food grade.

☒ 120 x 265 x 30 mm

🔪 **SCR** – 70 x 80 mm



## **Decnop** — 94689

Squeeze dobrável em PE com capacidade até 460 ml e acabamento matt. Food grade.

☒ 110 x 218 x 64 mm

🔪 **SCR** – 60 x 70 mm

Cores metálicas



## **Gilded** — 94690

Squeeze dobrável com mosquetão e tampa, com capacidade até 460 ml, disponível em cores metalizadas. Food grade.

☒ 110 x 218 x 64 mm

🔪 **SCR** – 70 x 60 mm



# Toalhas de esporte

O aliado para se esfriar durante a atividade física.

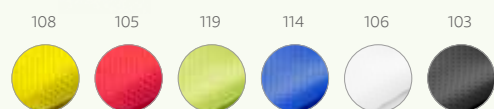

**NEW**  
rPET **ECÓlogic**

**Bernal** — 99969

Toalha esportiva refrescante em rPET. Fornecida numa bolsa preta em non-woven. Toalha reutilizável, lavável na máquina de lavar roupa.

300 x 800 mm | Bolsa: 100 x 200 mm

TRS – 200 x 200 mm

Quando molhada, permanece fria durante horas



**Artx Plus** — 99967

Kit toalha e garrafa. Toalha para esporte em poliamida e poliéster. Toalha refrescante, quando molhada permanece fria durante horas. Se aquecer, basta balançar reativando sua frescura. Reutilizável e lavável à máquina. Garrafa em PP e PET com mosquetão incluso (food grade). Capacidade até 440 ml. Caixa branca 94653 vendida opcionalmente.

300 x 800 mm | Garrafa: Ø65 x 183 mm

TRS – 100 x 60 mm



**NEW**

**Artx** — 99968

Toalha esportiva em poliamida e poliéster. Toalha refrescante, quando molhada permanece fria durante algumas horas. Se aquecer, basta abanar, reativando a sua frescura. Toalha reutilizável, lavável na máquina de lavar roupa.

300 x 800 mm

TRS – 200 x 150 mm

Elevada absorção e secagem rápida



**Matira** — 99965

Toalha para esporte em microfibras (210 g/m<sup>2</sup>). Toalha prática e leve que facilita o transporte, de elevada absorção e rápida secagem. Fornecida com bolsa em 190T.

300 x 300 mm | Bolsa: 110 x 140 mm

TRS – 60 x 50 mm

**Travis** — 99966

Toalha para esporte em microfibras (210 g/m<sup>2</sup>). Toalha prática e leve que facilita o transporte, de elevada absorção e rápida secagem. Fornecida com bolsa em 190T.

400 x 800 mm | Bolsa: 135 x 205 mm

TRS – 80 x 80 mm

# Seja visto a qualquer distância

- Colete refletivo para crianças

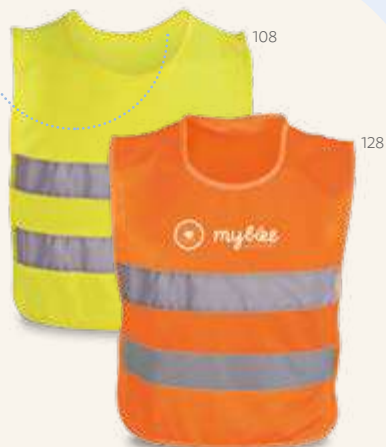

NEW

## Mike — 98501

Colete refletivo para criança em poliéster (100%). Contém 2 bandas retrorrefletivas horizontais, fecho com velcro lateral e é certificado pela norma EN 17353. Produto não destinado para uso profissional.

☒ Tamanho único: 370 x 470 mm

🔪 TRS – 230 x 60 mm



NEW

## Roger — 98504

Bolsa em 100% poliéster com fecho de velcro. Indicada para guardar o colete 98503.

☒ 145 x 220 mm

🔪 TRS – 70 x 150 mm



NEW

## Thiem — 98502

Colete de alta visibilidade em 100% poliéster com certificado pela norma EN 17353. Colete refletivo com 2 bandas refletoras horizontais e elásticos laterais. Este produto não é adequado para uso profissional.

☒ 540 x 620 mm

🔪 TRS – 100 x 90 mm



NEW

## Yellowstone — 98503

Colete de alta visibilidade em 100% poliéster com certificado pela norma EN ISO 20471 classe 2. Colete refletivo com 2 bandas refletoras horizontais e abertura frontal com fecho de velcro.

☒ Tamanho único: 670 x 700 mm

🔪 TRS – 140 x 100 mm



## Rules — 92835

Sacola tipo mochila em 210D, com elementos refletivos. Produto promocional.

☒ 350 x 400 mm

🔪 TXP – 250 x 160 mm



103

Elementos  
refletores



**Confor** — 97207

Braçadeira para celular em soft shell de alta densidade, com elementos refletivos e fechamento ajustável. Para smartphone 6.5".

☒ 440 x 175 mm

☒ SCR – 25 x 40 mm



103

**Spirited** — 97205

Braçadeira para celular em soft shell com banda refletiva e fechamento ajustável. Para smartphone 5.1".

☒ 450 x 165 mm

☒ SCR – 38 x 45 mm



**Mounti** —  
92628

☒ .194



**Wilkins** —  
97341

☒ .79

Bolso ideal  
para pequenos  
objetos



123

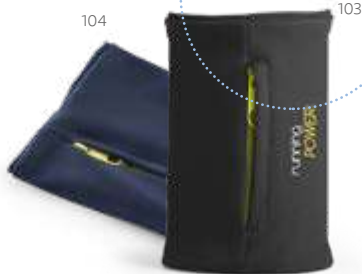

104

103



106

103

**Yates** — 92799

Bolsa para bicicleta em 600D, com 3 fitas ajustáveis.

☒ 230 x 200 x 60 mm

☒ TRS – 90 x 45 mm



**Picchu** — 99023

Punho elástico em poliéster com bolso com zíper, ideal para guardar bens de pequeno tamanho e usar durante a prática esportiva.

☒ 100 x 100 mm

☒ TRS – 50 x 50 mm

**Kov** — 99022

Punho elástico em poliéster com área apropriada para personalização, disponível em várias cores.

☒ 75 x 78 mm

☒ TRS – Ø20 mm





## 4 níveis de resistência

Muito leve



Leve



Média



Forte



NEW

A

### Burpee — 99970

Conjunto de 4 bandas elásticas de ginástica em bolsa de non-woven preta. Cada banda tem um nível de resistência diferente: Vermelha - forte; Amarela - média; Azul - leve; Verde - muito leve

📏 Bolsa: 100 x 200 mm

🔪 TRS - 80 x 140 mm



Zippers Sport — 92516

📏 .180



Fit — 92511

📏 .195



B



### Brady — 98086

Kit fitness composto por elástico e corda de pular. Fornecido com bolsa em 190T.

📏 Bolsa: 210 x 270 mm

🔪 TRS - 150 x 150 mm



# Escolha o melhor utensílio para o acompanhar em suas atividades e esteja preparado para resolver qualquer imprevisto



• Com **4** leds e **5** pontas diferentes

123

## LED **Gabro** — 94017

Conjunto de ferramentas em ABS com clipe, 4 LEDs e 5 pontas diferentes removíveis. Incluso 2 pilhas AAA.

∓ 90 x 30 x 35 mm

↗ PDP – 25 x 10 mm



114

114



147



## **Basalt** — 94020

Conjunto de mini chave de parafusos em metal com 3 pontas diferentes removíveis com opção de guardar as peças no topo do corpo com tampa. Chaveiro incluído.

∓ Ø13 x 75 mm

↗ LSR – 30 x 6 mm



A

103



104

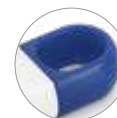

106



105



A

## **Chert** — 94018

Conjunto de mini chave de parafusos em PS com 4 pontas diferentes removíveis com opção de guardar as peças no corpo.

∓ 92 x 22 x 13 mm

↗ SCR – 55 x 10 mm





NEW

Inox **Dunito** — 94016

Mini alicate multifunções dobrável em aço inox e alumínio com 9 funções. Fornecido em bolsa de 600D.

📏 Fechado: 35 x 70 x 18 mm | Bolsa: 50 x 90 x 20 mm

🔪 LSR – 25 x 4 mm

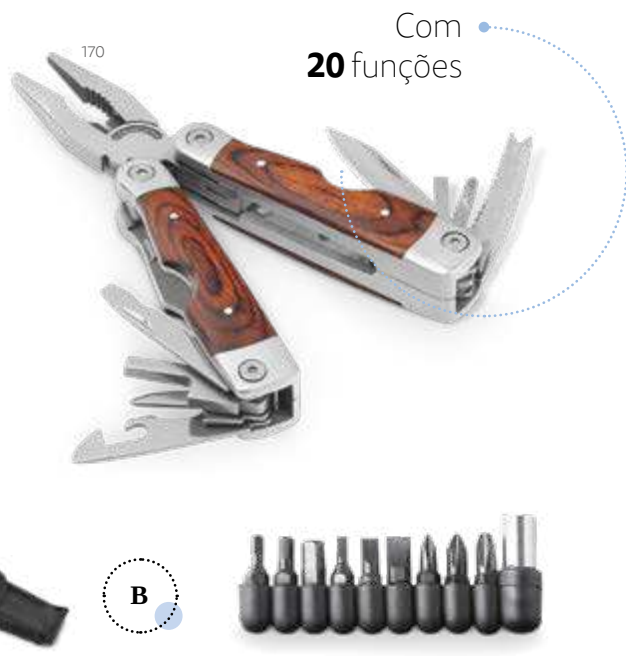

Com **20** funções

NEW

Inox **Magnum** — 94022

Alicate dobrável com ferramentas multifunções em aço inox e madeira, com 20 funções. Fornecido em bolsa em poliéster.

📏 45 x 100 x 25 mm | Bolsa: 65 x 140 x 30 mm

🔪 PDP – 30 x 25 mm



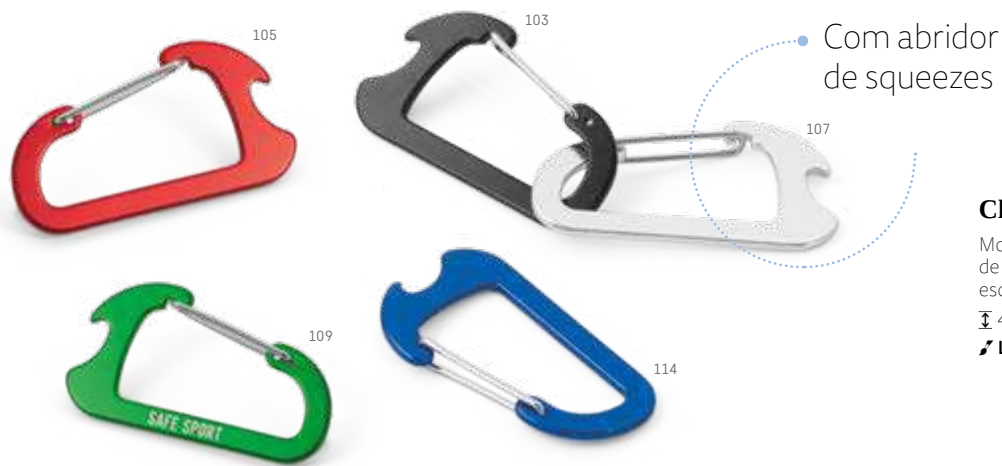

**Close** — 98824

Mosquetão em alumínio com abridor de garrafas. Não adequado para escalada esportiva.

▮ 44 x 79 x 3 mm

↗ LSR - 50 x 5 mm



**Bresset** — 98823

Mosquetão em alumínio com área plana para gravação.

▮ 32 x 57 x 5 mm

↗ LSR - 30 x 3 mm



**Limardo** — 98822

Mosquetão em alumínio com área plana para gravação.

▮ 24 x 48 x 4 mm

↗ LSR - 25 x 3 mm



Criança  
& Escolar



A





**Valorize  
a imaginação  
das crianças  
e torne  
os momentos  
de brincadeira  
mais divertidos**



**EcoLogic**

**Croco** — 51746

Caixa de cartão  
com 12 lápis de cor.

▮ 90 x 180 x 9 mm

✂ SCR – 60 x 90 mm



**EcoLogic**

**Crafti** — 51931

Caixa de cartão  
com 10 mini lápis de cor.

▮ 40 x 90 x 15 mm

✂ SCR – 25 x 50 mm



**EcoLogic**

**Bird** — 51750

Caixa de cartão  
com 6 mini lápis de cor.

▮ 45 x 90 x 9 mm

✂ SCR – 35 x 50 mm



**EcoLogic**

**Coloured** — 51747

Caixa de cartão  
com 12 lápis de cor.

▮ 90 x 90 x 9 mm

✂ SCR – 45 x 60 mm



160

8 desenhos  
para colorir



### Jaguar — 51755

Kit para pintar em caixa de cartão. Incluso 8 giz de cera e 8 cartões diferentes para pintar e pendurar.

▮ 180 x 90 x 10 mm

▮ SCR - 55 x 60 mm



160

### Eagle — 51754

Caixa de cartão com 6 giz de cera.

▮ 53 x 92 x 9 mm

▮ SCR - 40 x 50 mm



160

### Anim — 51758

Kit para pintar em caixa de cartão. Incluso 6 mini lápis de cor, 1 apontador e 15 cartões diferentes para pintar.

▮ 73 x 89 x 12 mm

▮ SCR - 50 x 55 mm



105

105

108

119

124

### Cuckoo — 93466

Caderno para colorir com 25 desenhos diferentes. Capa disponível em várias cores. Lápis não inclusos.

▮ 90 x 90 mm

▮ SCR - 70 x 60 mm

# Preparados para aprender!



## Rhombus — 51932

Kit de escrita composto por régua de 16,5 cm, 2 lápis de grafite, 1 borracha e 1 apontador. Fornecido com bolsa em cartão.

☒ Bolsa: 190 x 45 x 20 mm

☒ SCR – 170 x 30 mm



## Poodle — 51756

Conjunto de desenho fornecido em caixa de madeira. Incluso uma régua de 20 cm, seis lápis de cor, um lápis de grafite, um apontador e uma borracha.

☒ 220 x 43 x 32 mm

☒ LSR – 190 x 20 mm



## Rols — 51751

Caixa cilíndrica em cartão com 6 mini lápis de cor. Incluso apontador.

☒ Ø26 x 106 mm

☒ PDP – 10 x 45 mm



## Cricket — 51752

Caixa cilíndrica em cartão com 12 lápis de cor para pintar.

☒ Ø35 x 97 mm

☒ PDP – 10 x 45 mm





**Ateneo** — 51736

Lápis com borracha.  
Grau de dureza: HB.

∓ Ø7 x 190 mm

↙ PDP - 40 x 5 mm



**Beetle** — 51904

Lápis apontado  
com boneco de borracha.  
Grau de dureza: HB.

∓ Ø7 x 188 mm

↙ PDP - 40 x 5 mm



**Rizzoli** — 51738

Lápis apontado. Grau de dureza: HB.

∓ Ø8 x 175 mm

↙ PDP - 40 x 5 mm



**Aguza** — 53621

Apontador 2 em 1 em PS com depósito transparente e borracha com tampa.  
Disponível em várias cores.

∓ 41 x 60 x 23 mm

➤ PDP – 20 x 10 mm



**Yglo** — 93620

Apontador em PS com depósito.  
Disponível em várias cores.

∓ 41 x 40 x 30 mm

➤ PDP – 15 x 6 mm



**Ernster**  
51721

∓ .156



**Barter** —  
51759

∓ .156

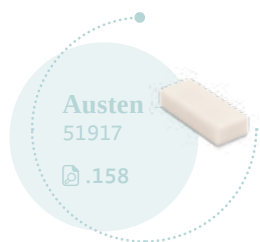

**Austen**  
51917

∓ .158



**Cornwell**  
51716

∓ .156

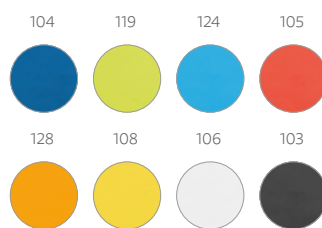

**Siza** — 51935

Borracha em TPR com capa protetora em PP.

∓ 55 x 33 x 13 mm

➤ PDP – 20 x 15 mm





128



119



128

119

124

104

105

131

103



119

124

104

105

128

### Hummingbird — 93614

Estojo para lápis em 600D.

∩ 210 x 85 x 65 mm

✂ TRS – 130 x 60 mm

### Colorit — 93619

Estojo para lápis em non-woven (100 g/m<sup>2</sup>).

∩ 210 x 110 mm

✂ TRS – 150 x 60 mm

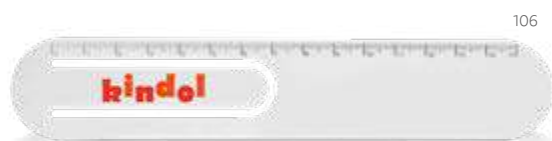

106

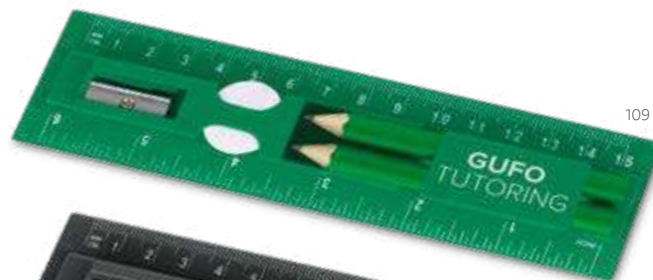

109



105

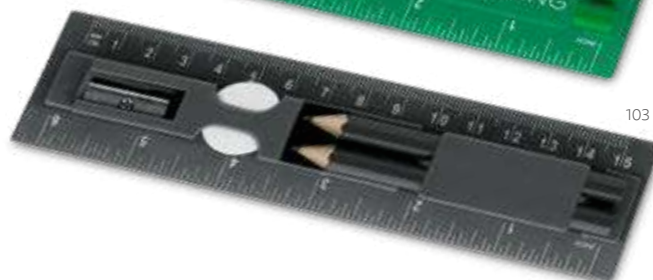

103

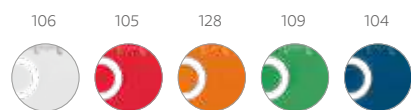

106

105

128

109

104

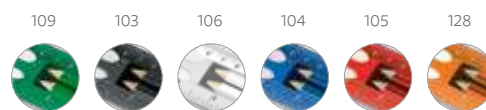

109

103

106

104

105

128

### Stephenie — 53565

Régua com escala de 15 cm impressa, cantos redondos e com clipe.

∩ 174 x 31 x 2 mm

✂ SCR – 55 x 8 mm

### Gufo — 93566

Kit de escrita em PS. Incluso régua de 15 cm, 2 mini lápis, 1 borracha e 1 apontador.

∩ Régua: 157 x 42 x 15 mm

✂ PDP – 30 x 15 mm





## Estojo em algodão

ecologic

Schooli — 93607

Estojo para lápis em algodão.

∅ 70 x 220 mm

TR5 - 130 x 60 mm



# Estimular a criatividade

Pintar é uma das brincadeiras mais completas, pois ajuda a estimular e a desenvolver a criatividade.



3 desenhos para colorir



**Giraffe** — 54635

Copo para viagem para crianças em PP e PS com canudo flexível e capacidade até 200 ml. Corpo com 3 desenhos diferentes para colorir (6 mini lápis em cor inclusos). Food grade.

∅ 72 x 98 mm

PDP – 25 x 30 mm



**Baloo** — 52619

Sacola tipo mochila para colorir em non-woven (80 g/m<sup>2</sup>) com desenho impresso e bolso interior. 6 gizos de cera inclusos.

300 x 350 mm

TRS – 200 x 60 mm



**Gusteau** — 59834

Avental de criança para colorir em non-woven (80 g/m<sup>2</sup>) com desenho impresso e bolso lateral. 6 gizos de cera inclusos.

380 x 430 mm

TRS – 120 x 120 mm





**Lavender** — 99826

Avental para criança em non-woven (80 g/m<sup>2</sup>) com bolso e alças ajustáveis.

☒ 400 x 600 mm |

Bolso: 200 x 150 mm

✂ TRS - 150 x 100 mm



**Bissaya** — 92617

Sacola tipo mochila em non-woven (80 m/g<sup>2</sup>) com cantos triangulares coloridos.

☒ 300 x 350 mm

✂ TXP - 160 x 160 mm

Colete refletivo para crianças



**NEW**

**Mike** — 98501

Colete refletivo para criança em poliéster (100%). Contém 2 bandas retrorrefletivas horizontais, fecho com velcro lateral e é certificado pela norma EN 17353. Produto não destinado para uso profissional.

☒ Tamanho único: 370 x 470 mm

✂ TRS - 230 x 60 mm





124



124

104

119

105

128

131

103



124

**Berna** — 92667

Mochila em 600D com bolso frontal com fecho. Parte posterior e alças almofadadas.

▮ 310 x 410 x 120 mm

▮ TRS - 130 x 80 mm

**Rocket** — 92614

Mochila em 600D com bolso frontal com zíper e 2 bolsos laterais em tela.

▮ 240 x 320 x 80 mm

▮ TRS - 140 x 90 mm



105

A

**Benny** — 92615

Mochila em 600D com bolso frontal e bolsos laterais com zíper.

▮ 240 x 320 x 120 mm

▮ TRS - 130 x 100 mm



A



**B**



**C**



105



124

105

**B**



105



106



124



**Turtle** — 58412

Bolsa térmica em 600D com bolso interior em rede e alça ajustável em webbing. Com capacidade até 4,5 L, tem o tamanho ideal para levar refeições para o trabalho ou escola. Food grade

▮ 200 x 200 x 110 mm

▮ TRS - 160 x 160 mm

**C**



**Sebastian** — 98416

Bolsa térmica para criança em 600D com bolso frontal, fechamento em zíper e bolso lateral em rede. Contém alça ajustável em webbing e tem capacidade até 3 L. Food grade

▮ 190 x 230 x 80 mm

▮ TRS - 150 x 90 mm



# Guarda-chuvas infantis



100



**Bambi** — 99133

Guarda-chuva para criança em poliéster e pega em EVA.

∅ 680 x 550 mm  
TXP – 150 x 90 mm



105



105

123

124

**Stork** — 99123

Guarda-chuva para criança em poliéster 190T.

∅ 870 mm | 660 mm  
TXP – 150 x 120 mm



**Nicholas**  
99143

.393





# Sol & Chuva





ZEVI





Varetas de fibra de vidro

# Guarda-chuva grande de portaria

103



Aproximadamente **1,4 m** de diâmetro

103

106

104



NEW



**Eiger** — 99042



Guarda-chuva grande de portaria em 190T pongee. Varetas e haste em fibra de vidro e pega em madeira.

∅ 1375 x 855 mm

TR5 - 200 x 120 mm





## Uma afirmação de sustentabilidade!

Design diferenciador, útil mas sobretudo amigo do meio ambiente. Prepare-se para o inverno com opções mais responsáveis.

Abertura automática



160



ECologic

 **Sobral** — 99141

 Guarda-chuva em cortiça com haste e pega em madeira. Abertura automática.

∅1050 mm | 890 mm

TR5 - 200 x 120 mm



129

104

106

103



129



NEW

ecologic



**Apolo** — 99149



Guarda-chuva em rPET pongee com abertura automática, haste e estrutura em metal. Pega em madeira.

∅1050 x 850 mm

TR5 – 200 x 120 mm

104

## Guarda-chuva reversível

Modelo patenteado com uma tecnologia de desempenho excepcional, pensada para evitar molhar-se sempre que fecha o guarda-chuva.



**Angela** — 99146

Guarda-chuva reversível em pongee 190T com capa dupla, cabo em metal e varetas em fibra de vidro. O guarda-chuva de estrutura patenteada tem abertura manual e fecho automático.

∅1050 mm | 790 mm

TRP – 200 x 120 mm



103



Abertura automática



**Guil** — 99126

Guarda-chuva de 12 varetas em poliéster 190T e pega revestida a borracha com mecanismo de abertura automática.

∅1100 mm | 900 mm

TXP – 120 x 120 mm

105



Abertura automática

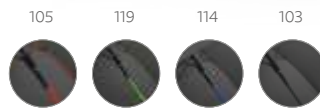

**Alberta** — 99145

Guarda-chuva em pongee 190T com varetas em fibra de vidro coloridas e pega revestida a borracha. Abertura automática.

∅1040 mm | 870 mm

TXP – 220 x 140 mm



# Prepare-se para o inverno

Os guarda-chuvas com tecido pongee são mais resistentes à água, secam mais depressa e são recicláveis. Para além disso a abertura automática e as varetas em fibra de vidro conferem-lhes maior segurança e utilidade.

104



Varetas de fibra de vidro

Pega revestida em borracha

104



103



NEW



**Sessil** — 99155



Guarda-chuva em 190T pongee, varetas em fibra de vidro, cabo em alumínio e haste revestida em borracha. Guarda-chuva à prova de vento com abertura automática. Fornecido em bolsa com alça curta para facilitar transporte.

☒ Guarda-chuva: Ø1025 x 855 mm | Bolsa: 90 x 635 mm

☒ TRS – 200 x 120 mm

113



113



104



**Silvan Stripe** — 99153



Guarda-chuva em 190T pongee com varetas em fibra de vidro e pega em c. sintético. Guarda-chuva à prova de vento com abertura automática.

☒ Ø1175 x 925 mm

☒ TXP – 200 x 150 mm

129



129



104



103



**Felipe** — 99130



Guarda-chuva de golfe em pongee 190T com haste e varetas em fibra de vidro e pega em PP. O guarda-chuva é à prova de vento e tem abertura automática. Fornecido em bolsa.

☒ Ø1170 mm | 880 mm | Bolsa: 85 x 725 mm

☒ TXP – 220 x 140 mm



## Efeito refletor

Em dias de chuva cinzentos, opte por guarda-chuvas com efeito refletor para uma maior segurança.



Abertura automática e pega revestida a borracha



Abertura automática e pega em alumínio



**Megan** — 99152  
Guarda-chuva em poliéster com faixa refletora. Pega revestida a borracha e abertura automática.  
∅960 x 815 mm  
TRP – 200 x 120 mm



**Karen** — 99115  
Guarda-chuva em poliéster 190T. Haste e pega em alumínio com mecanismo de abertura automática.  
∅1050 mm | 890 mm  
TRP – 220 x 140 mm

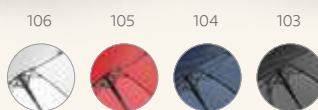

**Stuart** — 99142  
Guarda-chuva grande de portaria em 190T pongee com abertura automática. Varetas e haste em fibra de vidro e pega em madeira.  
∅1040 mm | 830 mm  
TRP – 220 x 140 mm

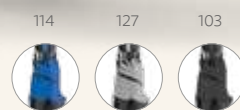

**Jenna** — 99137  
Guarda-chuva em poliéster 190T com pega em EVA e abertura automática. Detalhe com linha colorida no guarda-chuva e na pega.  
∅1040 mm | 825 mm  
TRP – 220 x 140 mm



Varetas de fibra de vidro



104

A

NEW



**Reno** — 99043

Guarda-chuva em 190T pongee com abertura automática. Varetas em fibra de vidro e pega e haste em madeira.

∅1040 x 885 mm

TR5 — 200 x 120 mm

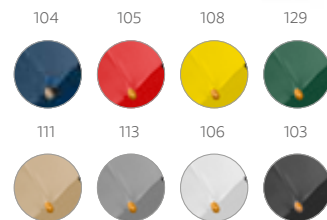

## Para dias de chuva ou de sol

O golf é um desporto que se pratica tanto em dias de chuva como em dias de sol, por isso ter um bom guarda-chuva ajudará a obter a concentração necessária.



103

**Karl** — 99122

Guarda-chuva de golfe em poliéster 190T com pega em EVA.

∅1220 mm | 975 mm

TXP — 220 x 140 mm



105

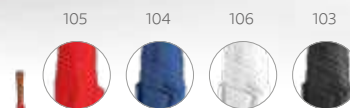

**Roberto** — 99109

Guarda-chuva de golfe em poliéster 190T e pega em madeira. Abertura manual.

∅1270 mm | 965 mm

TXP — 220 x 140 mm



LIVE A  
Colourful  
LIFE



 **Patti** — 99116  
 Guarda-chuva em poliéster 190T com haste em metal e pega em madeira e abertura automática.  
 Ø1040 mm | 885 mm  
 TXP – 220 x 140 mm



119



119



114



104



102



105



103

**Michael** — 99134

Guarda-chuva em poliéster 190T com pega revestida a borracha e abertura automática.

∅1040 mm | 830 mm

TXP – 220 x 140 mm



16 varetas

100

190T  
pongee**Duha** — 99140

Guarda-chuva arco-íris em 190T pongee com 16 varetas e pega em madeira.

∅1020 x 875 mm

TRS – 120 x 120 mm



106



106



103

**Nicholas** — 99143

Guarda-chuva transparente em POE com abertura automática.

∅1000 mm | 815 mm

PDP – 50 x 7 mm



113



113



111



105



129



104



106



103

**Betsey** — 99100

Guarda-chuva em poliéster 190T com haste e pega em madeira. Abertura manual.

∅1040 mm | 885 mm

TXP – 220 x 140 mm

# Compactos e práticos

Perfeitos para levar sempre consigo.

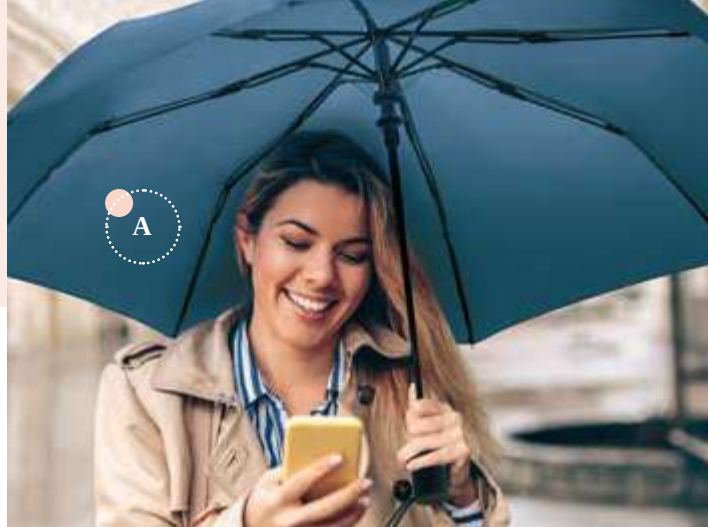

A



104

104

106

103



A



## Tomas — 99139

Guarda-chuva dobrável em poliéster 190T dobrável em 3 secções com abertura automática. Fornecido em bolsa.

∅980 mm | 295 mm | Bolsa: Ø45 x 245 mm

TXP – 200 x 120 mm



129



108

129

124

104

105

108

106

103



108

109

104

105

128

127

103



## Maria — 99138

Guarda-chuva em poliéster 190T dobrável em 3 secções e de abertura manual. Guarda-chuva prático e leve fornecido em bolsa.

∅960 mm | 240 mm | Bolsa: Ø40 x 215 mm

TRS – 200 x 120 mm

## Tigot — 99135

Guarda-chuva em poliéster 190T dobrável em 3 secções e de abertura manual. Disponível em várias cores, com interior em cinza. Guarda-chuva prático e leve fornecido em bolsa.

∅960 mm | 240 mm | Bolsa: Ø40 x 225 mm

TXP – 200 x 120 mm



• Pega revestida em borracha



104

103



• Abertura automática



### Campanela — 99151

Guarda-chuva dobrável em 190T pongee. Pega revestida em borracha e abertura automática. Fornecido em bolsa.

☒ Ø980 mm | 320 mm | Bolsa: Ø50 x 240 mm

☒ TXP – 200 x 100 mm



104

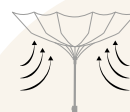

• À prova de vento

103



• Abertura e fecho automático



• Com lanterna na pega

### Muriel — 39000

Guarda-chuva em poliéster dobrável em 3 seções com lanterna na pega (incluso 2 pilhas CR2032). Fornecido em bolsa.

☒ Ø940 mm | 310 mm | Bolsa: Ø50 x 230 mm

☒ TXP – 200 x 120 mm



### Stella — 99147

Guarda-chuva em Pongee 190T dobrável em 3 seções e com abertura automática. Pega revestida a borracha. Guarda-chuva à prova de vento. Fornecido em bolsa.

☒ Ø970 mm | 280 mm | Bolsa: Ø50 x 250 mm

☒ TXP – 200 x 120 mm

# Guarda-chuvas infantis



105



100

105

123

124



A

**Stork** — 99123

Guarda-chuva para criança em poliéster 190T.

∅ 870 mm | 660 mm

TXP - 150 x 120 mm



**Bambi** — 99133

Guarda-chuva para criança em poliéster e pega em EVA.

∅ 680 x 550 mm

TXP - 150 x 90 mm





## Mais proteção contra a chuva

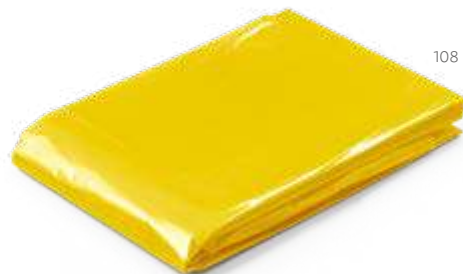

**Sandra** — 99213

Capa de chuva de tamanho único, disponível em várias cores. Fornecida em polybag.

∓ 1200 x 900 mm

✂ SCR - 75 x 55 mm



**Pedro** — 99215

Capa de chuva de tamanho único fornecida dentro de embalagem em formato de bola de futebol com chaveiro e mosquetão.

∓ Ø63 mm | 1200 x 900 mm

✂ PDP - 15 x 15 mm



**Isabel** — 99214

Capa de chuva de tamanho único, fornecida dentro de embalagem em formato de bola com chaveiro e mosquetão. Embalagem disponível em várias cores.

∓ Ø63 mm | 1200 x 900 mm

✂ DUV - 25 x 25 mm





Forro prateado



Cabo direcionável



**Parana** — 98320

Guarda-sol reclinável em 210T com forro prateado. Fornecido em bolsa com alça.

∅1400 mm | 1600 mm |

Bolsa: 1010 x 110 mm

TXP – 220 x 140 mm



**Dering** — 98332

Guarda-sol em poliéster 170T. Fornecido em bolsa.

∅1400 mm | 1600 mm |

Bolsa: 1000 x 120 mm

TXP – 220 x 140 mm



Quando a chuva  
passar e o sol  
aparecer, aproveite  
para se equipar com  
o essencial para  
a praia



129 106 104



**Azur** — 98329

Guarda-sol em 300D com interior prateado e cabo direcionável. Fornecido em bolsa.

☒ 1600 x 1600 mm | 1800 mm | Bolsa: 1050 x 130 mm

☒ TRS - 280 x 200 mm

# Mantenha o seu celular seguro com capas resistentes à água

A



Permite utilização touch



A

Permite utilização touch



**Egeu** — 98266

Bolsa para celular em PVC impermeável (não aconselhável imersão). A parte frontal é transparente e a parte dianteira é em branco fosco. Permite interagir com o tela a partir do exterior. A bolsa tem fechamento hermético e aba em cor com fechamento em velcro.

▮ 240 x 95 mm

▮ SCR - 60 x 120 mm



**Mamore** — 58315

Bolsa para celular em PVC. Bolsa impermeável (não aconselhável imersão) que permite utilização touch. Para smartphone 5.5".

▮ 100 x 220 mm

▮ SCR - 60 x 90 mm



# Escolha uma das diferentes cores da fita Burton para combinar com o chapéu Manolo



**NEW**

## Burton — 99428

Fita para chapéu em 100% poliéster, disponível para várias cores e de fácil personalização.

☒ 650 x 24 mm

✂ TRS - 380 x 18 mm



## Manolo — 99427

Chapéu em PP, disponível em várias cores. Fita não incluída.

☒ Tamanho: 58

✂

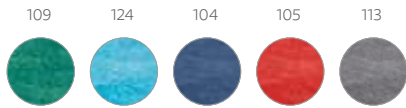

**Sardegna** — 98375

Toalha de praia em veludo de algodão (320 g/m<sup>2</sup>), disponível em várias cores. Fornecida com sacola em non-woven (80 g/m<sup>2</sup>).

☒ 1500 x 750 mm | Sacola: 330 x 415 x 100 mm

✂ TRS – 280 x 200 mm



A



**California** — 58377

Toalha de praia em microfibra (250 g/m<sup>2</sup>). Fornecida com sacola em non-woven (80 g/m<sup>2</sup>).

☒ 1500 x 750 mm | Sacola: 330 x 415 x 100 mm

✂ TRS – 280 x 200 mm



**Galapos** — 98247

Sacola almofada inflável em PVC opaco.

☒ Vazio: 300 x 320 mm

✂ SCR – 160 x 160 mm



### ECÓlogic



**Ville** — 92824

Sacola 100% algodão canvas (280 g/m<sup>2</sup>) com bolso frontal e bolso interior com zíper. A sacola contém fecho magnético e alças de 60 cm.

☒ 530 x 380 x 170 mm

☒ TRS – 120 x 150 mm



**Kenza** — 98424

Sacola de praia em 600D e alça de corda em algodão.

☒ 510 x 440 x 140 mm

☒ TRS – 280 x 200 mm

**Lolla** —  
98417

☒ .312



**Edmonton** —  
92822

☒ .298



Bolso interior



104



106

**Maresia** — 92513

Sacola de praia em 300D com bolso interior. Alças em webbing de 70 cm.

☒ 450 x 300 x 80 mm

☒ TRS – 240 x 200 mm





# Índice remissivo

Abridor de garrafas	274	Conjunto de desenho	373	Lápis	156, 374
Adaptador USB	98, 101	Conjunto de esferográfica e lapiseira	118, 138, 140	Lápis para colorir	157, 373, 374
Álcool Gel	218	Conjunto de porta copos	268	Luminária de mesa	53, 75, 87
Alicate	367	Conjunto de roller e esferográfica	112 - 116, 118	Luminária de mesa com caixa de som	53, 87
Almofada de pescoço	221	Conjunto de talheres	250, 278	Luva refrigeradora	271, 272
Ampulheta de banho	214	Conjunto para vinho	269, 271	Mala de cosméticos	170
Anti-estresse	223	Copo de viagem	217, 321, 323, 329, 346 - 353, 378	Mala de viagem	170
Apontador	375	Copo para salada	283	Mala de viagem executivo	167 - 171
Avental	284 - 286	Copos	321, 322, 348, 352	Manta	225, 288
Avental de criança para colorir	378, 379	Cortador de pizza	282	Marmita	264, 265, 279 - 282
Banda elástica refletora	224	Dema	143 - 145	Máscara para dormir	221
Base de mesa	255	Dispenser automático	219	Mini lápis	156
Bateria portátil	72, 89 - 96	ekston®	63 - 69	Mochila	176, 180 - 199, 313, 380
Blocos adesivados	48 - 51	Embalagem para esferográfica	132	Mochila para notebook	176 - 192
Bolsa de cintura	193	Embalagem para pastas A4	58	Mochila trolley para notebook	167, 172, 173, 177
Bolsa de cosméticos	205, 206, 208 - 211, 213	Esferográficas	112 - 141, 148	Mosquetão	244, 368
Bolsa de cosméticos hermética	212	Espelho de maquiagem	214, 215	Mouse wireless	100
Bolsa esportiva	180, 192, 195	Estação de carregamento USB	98	Óculos de realidade virtual	86
Bolsa multiusos	207, 210, 211	Esteira para grelha	263	Organizador de mesa	73
Bolsa para bicicleta	364	Estojo para esferográficas	132, 133	Pasta à tiracolo	191
Bolsa para celular	400	Estojo para lápis	376, 377	Pasta A4	52, 54, 56, 57, 58
Bolsa para notebook	106	Faca	228	Pasta A5	54, 57
Bolsa para sapatos	222	Fita para chapéu panamá	401	Pasta de congresso	200, 202
Bolsa térmica	312, 313, 315, 316, 381	Fone de ouvido	76 - 81	Pasta multifunções	200
Bolsa térmica dobrável	316	Fones de ouvido dobráveis	76, 78	Pasta para notebook	106, 190, 201
Bolsas	213, 246, 277	Fones de ouvido wireless	81	Pasta porta-documentos A4	52
Borracha	158, 375	Frasco com doseador	218	Pen Drive	97
Braçadeira para celular	364	Frasco de vidro	267	Pochete	193, 198
branve®	22 - 25, 108, 110, 161 - 165	Galheteiro	254	Porta cartões	48, 102, 103, 234, 246
Bule	323	Garrafa de vidro	267, 325	Porta celular para carros	104
Cabos USB	100	Garrafa térmica	321, 343	Porta comprimidos	216
Cadeira dobrável	225	Guarda-chuva	385, 386, 388 - 395	Porta copos	268, 274
Caderno	26 - 48, 51, 55, 88	Guarda-chuva para criança	382, 396	Porta crachás	51
Caderno para colorir	372	Guarda-sol	398, 399	Prato	254
Cafeteira	322	Hub USB 2.0	100	Protetor para webcam	105
Caixa	36, 358	Identificador de bagagem	220	Protetor solar para carros	224
Caixa de cartão com giz de cera	372	Kit churrasco	251, 256 - 263	Punho elástico	364
Caixa de cartão com lápis de cor	371	Kit de Cocktail	277	Régua	376
Caixa de cartão com mini lápis	371, 373	Kit de costura	222	Relógio	72
Caixa de chás	268	Kit de escrita	34, 157, 373, 376	Rolha de vácuo para garrafa	272
Caixa de som	72, 74, 75, 82 - 85	Kit de escritório	34, 37	roller	112, 116, 119, 123, 126, 128
Caixa esterilizadora	86, 219	Kit de ferramentas	366	Saca-rolhas	269, 271, 275
Caixa para pen drive	97	Kit de higiene para cachorro	224	Sacola	198, 254, 272, 273, 291, 292 - 316, 402, 403
Caneca	322, 348	Kit de jardinagem	287	Sacola de praia	403
Caneca para viagem	348	Kit de limpeza de sapatos	222	Sacola esportiva	174
Canivete	226 - 228, 367	Kit de lixas	214	Sacola tipo mochila	174, 292, 299 - 307, 363, 378, 379
Canudo	276	Kit de manicure	214, 215	Saladeira	250
Canudos	276, 278	Kit de porta cartões e chaveiro	233	Saleiro	254
Capa de chuva	387, 389, 397	Kit de porta cartões, chaveiro e esferográfica	233	Shaker	360
Capas	35	Kit de toalha e garrafa	362	Squeeze	319, 321 - 359
Carregador wireless	73, 74, 99	Kit de viagem	221	Suco®	6 - 17
Chapéu	401	Kit esferográfica e chaveiro	232	Toalha de praia	390 - 402
Chaveiro	231, 232, 235 - 245	Kit fitness	365	Toalha para esporte	362
Coletes	363, 379	Kit para escritório	49	Top Pen	147 - 155
Coluna de som	71	Kit para pintar em caixa de cartão	372	Travessa	255
Conjunto de canudo	277, 278	Lanterna	242, 243		

## Legenda de ícones

	100% algodão		BPA Free		Gênero feminino		Produto ECO
	140 folhas		Capacidade L		Guarda-chuva automático		Produto patenteado
	À prova de água		Capacidade mL		Guarda-chuva com varetas de fibra		Proteção térmica
	Aço inox		Comprimento do cabo		Imã		rPET
	Algodão orgânico		Elementos refletores		Lapiseira 0.5		Tamanho A4
	Algodão reciclado		Escrita a azul		Lapiseira 0.7		Tamanho A5
	Alta capacidade		Escrita a preto		Laser		Tamanho A6
	Apropriado para bebidas frias		Escrita a preto, azul e vermelho		LED		Tamanho A7
	Apropriado para bebidas quentes		Folhas não pautadas		LED COB		Tamanho B6
	Apropriado para comida		Folhas não pautadas cor marfim		Leitor de cartões TF		Tamanho B7
	Apropriado para congelador		Folhas pautadas		Painel solar		Tamanho de bolso
	Apropriado para máquina de lavar		Folhas pautadas cor marfim		Pega com mola		Transmissão por bluetooth
	Apropriado para microondas		Folhas pontilhadas cor marfim		Polegadas para notebook		Tratamento antibacteriano
	Bloqueio RFID		Fornecido em caixa presente		Produto amigo do ambiente		Unissex

## Códigos de cor

	102 Rosa		113 Cinza		132 Roxo
	103 Preto		114 Azulroyal		133 Cinza escuro
	104 Azul		119 Verde claro		134 Azul marinho
	105 Vermelho		122 Rosa escuro		137 Dourado satinado
	106 Branco		123 Cinza claro		139 Verde lima
	107 Cromado		124 Azul claro		144 Turquesa
	108 Amarelo		127 Cromado satinado		147 Chumbo
	109 Verde		128 Laranja		160 Natural
	110 Transparente		131 Bege		167 Champanhe

Advertimos para o fato da reprodução gráfica das fotografias poder causar diferenças de tonalidades em relação à cor dos produtos. As dimensões dos produtos e respetivas áreas de personalização recomendadas são meramente indicativas, podendo sofrer alterações sem aviso prévio.

# Índice: Nome — Referência

<b>Abe</b> — 91968	<b>132</b>	<b>Bernal</b> — 99969	<b>362</b>	<b>Chastain</b> — 92737	<b>213</b>	<b>Eindhoven</b> — 92145	<b>172</b>	<b>Hassi</b> — 94676	<b>349</b>
<b>Adams A5</b> — 93719	<b>28</b>	<b>Bertle</b> — 92635	<b>199</b>	<b>Chaucer</b> — 93497	<b>34</b>	<b>Eliot</b> — 93792	<b>49</b>	<b>Healy 5L</b> — 94895	<b>218</b>
<b>Adams A6</b> — 93720	<b>28</b>	<b>Beta Bamboo</b> — 81011	<b>137</b>	<b>Chert</b> — 94018	<b>366</b>	<b>Eliza</b> — 92731	<b>208</b>	<b>Healy 60</b> — 94892	<b>218</b>
<b>Adventure</b> — 92174	<b>182</b>	<b>Beta Soft</b> — 81141	<b>201</b>	<b>Chicago</b> — 92258	<b>131</b>	<b>Elliot</b> — 81009	<b>137</b>	<b>Healy 100</b> — 94893	<b>218</b>
<b>Aerial</b> — 94092	<b>276</b>	<b>Beto</b> — 92820	<b>297</b>	<b>Chicory</b> — 99835	<b>286</b>	<b>Elora</b> — 94300	<b>214</b>	<b>Healy 500</b> — 94894	<b>218</b>
<b>Aerial Wide</b> — 94094	<b>276</b>	<b>Betsey</b> — 99100	<b>393</b>	<b>Chill</b> — 98054	<b>223</b>	<b>Emerge A5 Folder</b> — 93581	<b>55</b>	<b>Hearkeen</b> — 97919	<b>66</b>
<b>Agua</b> — 53621	<b>375</b>	<b>Bielo</b> — 92038	<b>56</b>	<b>Chion</b> — 97396	<b>83</b>	<b>Emerge A5 Folder</b> — 93581	<b>88</b>	<b>Heat</b> — 94667	<b>343</b>
<b>Alberta</b> — 99145	<b>388</b>	<b>Bilbao</b> — 92848	<b>311</b>	<b>Chives</b> — 99822	<b>284</b>	<b>Emil</b> — 98111	<b>220</b>	<b>Heiden</b> — 99078	<b>288</b>
<b>Alcott A4</b> — 93272	<b>47</b>	<b>Bilbo</b> — 94879	<b>222</b>	<b>Christie</b> — 92058	<b>54</b>	<b>Emily</b> — 97384	<b>92</b>	<b>Helli</b> — 93394	<b>238</b>
<b>Alcott A5</b> — 93273	<b>47</b>	<b>Billy II</b> — 54957	<b>336</b>	<b>Cilantro</b> — 93854	<b>280</b>	<b>Emmy</b> — 97153	<b>100</b>	<b>Henderson</b> — 94264	<b>342</b>
<b>Alcott A6</b> — 93274	<b>47</b>	<b>Bio</b> — 91291	<b>352</b>	<b>Cinnamon</b> — 94626	<b>141</b>	<b>Empire Backpack</b> — 92680	<b>162</b>	<b>Hera</b> — 81163	<b>138</b>
<b>Aldrin X</b> — 57904	<b>90</b>	<b>Bird</b> — 51750	<b>371</b>	<b>City</b> — 92665	<b>196</b>	<b>Empire Notebook</b> — 93598	<b>23</b>	<b>Hexa</b> — 92288	<b>192</b>
<b>Alecar</b> — 97399	<b>100</b>	<b>Birmingham</b> — 52637	<b>187</b>	<b>Clane</b> — 94195	<b>244</b>	<b>Empire Suitcase I</b> — 92360	<b>163</b>	<b>Hexa Sport</b> — 92515	<b>192</b>
<b>Alicante</b> — 92911	<b>306</b>	<b>Bissaya</b> — 92617	<b>379</b>	<b>Clare</b> — 81156	<b>122</b>	<b>Empire Suitcase II</b> — 92359	<b>163</b>	<b>Hibiscus</b> — 93978	<b>268</b>
<b>Alick</b> — 94035	<b>226</b>	<b>Bit</b> — 97162 / 97941 / 97944	<b>96</b>	<b>Clark</b> — 92041	<b>56</b>	<b>Erald</b> — 94623	<b>339</b>	<b>Himalayas</b> — 94664	<b>348</b>
<b>Alioli</b> — 94139	<b>258</b>	<b>Blackwall</b> — 93353	<b>235</b>	<b>Cleat</b> — 93360	<b>242</b>	<b>Eraster</b> — 51721	<b>156</b>	<b>Holly</b> — 57335	<b>84</b>
<b>Alioli Board</b> — 94143	<b>258</b>	<b>Blackwell 2.4</b> — 57304	<b>100</b>	<b>Close</b> — 98824	<b>244</b>	<b>Eucleidan</b> — 57340	<b>84</b>	<b>Holz</b> — 94134	<b>274</b>
<b>Alioli King</b> — 94140	<b>258</b>	<b>Blake</b> — 93367	<b>238</b>	<b>Close</b> — 98824	<b>368</b>	<b>Euna</b> — 94852	<b>214</b>	<b>Homier</b> — 93167	<b>240</b>
<b>Almodovar</b> — 93489	<b>28</b>	<b>Blanchett</b> — 92735	<b>206</b>	<b>Clouds</b> — 94632	<b>356</b>	<b>Exo Mm</b> — 31013	<b>143</b>	<b>Hooke</b> — 97367	<b>104</b>
<b>Aloy</b> — 95050	<b>231</b>	<b>Blare</b> — 97257	<b>67</b>	<b>Coast</b> — 98425	<b>314</b>	<b>Expres</b> — 93873	<b>322</b>	<b>Hook Matte</b> — 81003	<b>110</b>
<b>Alps</b> — 91333	<b>129</b>	<b>Blazon</b> — 81147	<b>119</b>	<b>Cobb</b> — 98117	<b>222</b>	<b>Ezekiel</b> — 81195	<b>112</b>	<b>Hopper</b> — 57935	<b>77</b>
<b>Alsi</b> — 94051	<b>279</b>	<b>Blend</b> — 94247	<b>271</b>	<b>Coben</b> — 93474	<b>30</b>	<b>Ezekiel Roller</b> — 81196	<b>112</b>	<b>Horde</b> — 97921	<b>68</b>
<b>Americano</b> — 94785	<b>322</b>	<b>Block</b> — 93334	<b>103</b>	<b>Coimbra</b> — 92090	<b>167</b>	<b>Ezekiel Set</b> — 81210	<b>112</b>	<b>Horus 1</b> — 94650	<b>358</b>
<b>Amora</b> — 30512	<b>17</b>	<b>Blug</b> — 98067	<b>223</b>	<b>Collina</b> — 94246	<b>339</b>	<b>Fabris</b> — 93829	<b>254</b>	<b>Horus 2</b> — 94651	<b>358</b>
<b>Amora Wh</b> — 30513	<b>17</b>	<b>Bocage</b> — 92045	<b>56</b>	<b>Colnar</b> — 92912	<b>306</b>	<b>Falcon II</b> — 94031	<b>227</b>	<b>Horus 3</b> — 94652	<b>358</b>
<b>Amora Women</b> — 30514	<b>17</b>	<b>Bocuse</b> — 93853	<b>281</b>	<b>Colombia</b> — 94194	<b>272</b>	<b>Farday</b> — 57360	<b>80</b>	<b>Horus 4</b> — 94653	<b>358</b>
<b>Amora Women Wh</b> — 30515	<b>17</b>	<b>Bolzano</b> — 92934	<b>305</b>	<b>Colorit</b> — 93619	<b>376</b>	<b>Faulkner</b> — 93794	<b>50</b>	<b>Horus 5</b> — 94654	<b>358</b>
<b>Amorti</b> — 94958	<b>333</b>	<b>Bondi</b> — 92821	<b>296</b>	<b>Coloured</b> — 51747	<b>371</b>	<b>Felipe</b> — 99130	<b>389</b>	<b>Horus 6</b> — 94655	<b>358</b>
<b>Amy</b> — 81115	<b>152</b>	<b>Boole 1.5</b> — 97946	<b>96</b>	<b>Confor</b> — 97207	<b>364</b>	<b>Feria</b> — 92869	<b>294</b>	<b>Hous</b> — 98057	<b>223</b>
<b>Ancer</b> — 94687	<b>357</b>	<b>Boracay</b> — 52085	<b>189</b>	<b>Conley</b> — 94621	<b>359</b>	<b>Findo</b> — 98124	<b>220</b>	<b>Hubble</b> — 97076	<b>94</b>
<b>Angela</b> — 99146	<b>388</b>	<b>Borba</b> — 92819	<b>273</b>	<b>Cooper</b> — 93791	<b>49</b>	<b>Fit</b> — 92511	<b>195</b>	<b>Hugo</b> — 93591	<b>33</b>
<b>Angle Bpack</b> — 92270	<b>181</b>	<b>Bosi</b> — 99814	<b>285</b>	<b>Coorin</b> — 93717	<b>40</b>	<b>Fitch Eco</b> — 57909	<b>72</b>	<b>Hummingbird</b> — 93614	<b>376</b>
<b>Anim</b> — 51758	<b>372</b>	<b>Boston</b> — 92675	<b>176</b>	<b>Cork</b> — 81401	<b>134</b>	<b>Fitzgerald</b> — 92040	<b>58</b>	<b>Hygge</b> — 94678	<b>346</b>
<b>Aniston</b> — 94856	<b>214</b>	<b>Botaly</b> — 94144	<b>263</b>	<b>Corks</b> — 93145	<b>232</b>	<b>Flaubert</b> — 93709	<b>48</b>	<b>Hyper</b> — 57906	<b>99</b>
<b>Anjelica</b> — 92716	<b>211</b>	<b>Bottura</b> — 93844	<b>259</b>	<b>Cornish</b> — 93428	<b>44</b>	<b>Flemi</b> — 93397	<b>239</b>	<b>Ilford</b> — 92914	<b>299</b>
<b>Annatto</b> — 94141	<b>260</b>	<b>Bourchier</b> — 93363	<b>235</b>	<b>Cornwell</b> — 51716	<b>156</b>	<b>Flroy II</b> — 57252	<b>85</b>	<b>Ingrid I</b> — 92733	<b>213</b>
<b>Annie</b> — 92717	<b>211</b>	<b>Bouvier</b> — 93729	<b>39</b>	<b>Cotia</b> — 92723	<b>209</b>	<b>Florian</b> — 98514	<b>224</b>	<b>Ingrid II</b> — 92734	<b>213</b>
<b>Apolo</b> — 99149	<b>387</b>	<b>Bow</b> — 97328	<b>84</b>	<b>Coulomb 4.0</b> — 57344	<b>91</b>	<b>Fortalez</b> — 52081	<b>177</b>	<b>Inky</b> — 91847	<b>130</b>
<b>April</b> — 92545	<b>193</b>	<b>Boxp</b> — 92904	<b>307</b>	<b>Covent</b> — 92847	<b>311</b>	<b>Fortay Tw</b> — 57938	<b>176</b>	<b>Iruilan</b> — 92630	<b>58</b>
<b>Arasta</b> — 92924	<b>309</b>	<b>Boyd</b> — 93276	<b>31</b>	<b>Crafti</b> — 51931	<b>371</b>	<b>Franck</b> — 93331	<b>103</b>	<b>Isabel</b> — 99214	<b>397</b>
<b>Arky</b> — 92166	<b>181</b>	<b>Brady</b> — 98086	<b>365</b>	<b>Creta</b> — 92085	<b>189</b>	<b>Frankfurt</b> — 92156	<b>200</b>	<b>Istanbul</b> — 92083	<b>307</b>
<b>Arleta</b> — 92859	<b>309</b>	<b>Braga</b> — 92823	<b>293</b>	<b>Crick 2.4</b> — 57398	<b>100</b>	<b>Fred</b> — 94037	<b>226</b>	<b>Izmir</b> — 98409	<b>316</b>
<b>Artx</b> — 99968	<b>362</b>	<b>Bramble</b> — 94043	<b>277</b>	<b>Crocket</b> — 51752	<b>373</b>	<b>Freud</b> — 93578	<b>229</b>	<b>Jacky</b> — 81119	<b>155</b>
<b>Artx Plus</b> — 99967	<b>362</b>	<b>Bree</b> — 92852	<b>210</b>	<b>Croco</b> — 51746	<b>371</b>	<b>Froome</b> — 93396	<b>237</b>	<b>Jacky Bk</b> — 81120	<b>154</b>
<b>Arsmov</b> — 93715	<b>44</b>	<b>Bren</b> — 92182	<b>188</b>	<b>Crowd</b> — 97917	<b>69</b>	<b>Funfaye</b> — 94116	<b>274</b>	<b>Jagnar</b> — 51755	<b>372</b>
<b>Atala</b> — 94101	<b>263</b>	<b>Brendon</b> — 93315	<b>233</b>	<b>Crowe</b> — 92715	<b>208</b>	<b>Gabro</b> — 94017	<b>366</b>	<b>Jaipur</b> — 98408	<b>313</b>
<b>Ateneo</b> — 51736	<b>156</b>	<b>Bresset</b> — 98823	<b>368</b>	<b>Cubot</b> — 94138	<b>262</b>	<b>Gagarin</b> — 97394	<b>95</b>	<b>Jame</b> — 93448	<b>51</b>
<b>Ateneo</b> — 51736	<b>374</b>	<b>Brighter</b> — 94746	<b>242</b>	<b>Cuckoo</b> — 93466	<b>372</b>	<b>Galapos</b> — 98247	<b>402</b>	<b>James</b> — 93155	<b>239</b>
<b>Atwood A5</b> — 93492	<b>42</b>	<b>Bronte</b> — 93422	<b>48</b>	<b>Cuppa</b> — 94058	<b>351</b>	<b>Galilei</b> — 97951	<b>105</b>	<b>Janne</b> — 97318	<b>100</b>
<b>Atwood A6</b> — 93493	<b>42</b>	<b>Brooklyn</b> — 92081	<b>177</b>	<b>Cuiver II</b> — 57929	<b>74</b>	<b>Galois</b> — 57930	<b>75</b>	<b>Jasmin 800</b> — 94235	<b>267</b>
<b>Atwood B6</b> — 93723	<b>42</b>	<b>Bruges 33L</b> — 92159	<b>169</b>	<b>Dakar</b> — 94699	<b>324</b>	<b>Garbi</b> — 92197	<b>201</b>	<b>Jasmin 800</b> — 94235	<b>325</b>
<b>Austen</b> — 51917	<b>158</b>	<b>Bruges 90L</b> — 92297	<b>169</b>	<b>Dale</b> — 92916	<b>308</b>	<b>Garcia</b> — 93827	<b>268</b>	<b>Jasmin 1000</b> — 94236	<b>267</b>
<b>Autograph</b> — 81205	<b>108</b>	<b>Brussels</b> — 92169	<b>192</b>	<b>Daney</b> — 81155	<b>126</b>	<b>Garden</b> — 93708	<b>44</b>	<b>Jasmin 1000</b> — 94236	<b>325</b>
<b>Avairo</b> — 92176	<b>181</b>	<b>Buenos Aires</b> — 92186	<b>170</b>	<b>Dante</b> — 91491	<b>129</b>	<b>Gardner</b> — 97357	<b>100</b>	<b>Jay</b> — 94061	<b>359</b>
<b>Avenir</b> — 92177	<b>173</b>	<b>Buffon</b> — 94078	<b>331</b>	<b>Darwin II</b> — 57390	<b>72</b>	<b>Garlic</b> — 94145	<b>256</b>	<b>Jeddah</b> — 98406	<b>316</b>
<b>Avery</b> — 92352	<b>106</b>	<b>Bulfinch</b> — 93461	<b>46</b>	<b>Day</b> — 97371	<b>93</b>	<b>Garlic King</b> — 94142	<b>256</b>	<b>Jenna</b> — 99137	<b>390</b>
<b>Avila</b> — 91492	<b>128</b>	<b>Burnell Bk</b> — 57908	<b>99</b>	<b>Decnop</b> — 94689	<b>361</b>	<b>Gauguin</b> — 92638	<b>198</b>	<b>Jenson</b> — 94237	<b>322</b>
<b>Azofi</b> — 97079	<b>90</b>	<b>Burpee</b> — 99970	<b>365</b>	<b>Deep</b> — 98012	<b>223</b>	<b>Gauthier</b> — 93967	<b>268</b>	<b>Jerome</b> — 92883	<b>273</b>
<b>Azur</b> — 98329	<b>399</b>	<b>Burton</b> — 99428	<b>401</b>	<b>Deli</b> — 91814	<b>120</b>	<b>Gavis</b> — 94835	<b>214</b>	<b>Jimmy</b> — 94305	<b>216</b>
<b>Bachmann</b> — 93171	<b>236</b>	<b>Cabernet</b> — 94190	<b>269</b>	<b>Denim</b> — 93594	<b>33</b>	<b>Gent</b> — 57395	<b>82</b>	<b>Joan</b> — 91694	<b>130</b>
<b>Bacuri</b> — 94691	<b>351</b>	<b>Caine</b> — 57326	<b>98</b>	<b>Deniro</b> — 92722	<b>212</b>	<b>Geometric Notebook</b> — 93596	<b>24</b>	<b>Jolly</b> — 57907	<b>99</b>
<b>Bago</b> — 92517	<b>195</b>	<b>Cairo</b> — 92084	<b>302</b>	<b>Denver</b> — 92321	<b>188</b>	<b>Georges</b> — 97150	<b>104</b>	<b>Julep</b> — 94090	<b>276</b>
<b>Bahia</b> — 91820	<b>137</b>	<b>California</b> — 58377	<b>402</b>	<b>Derby</b> — 92523	<b>185</b>	<b>Germout</b> — 58519	<b>86</b>	<b>Julie</b> — 81144	<b>123</b>
<b>Baird</b> — 92844	<b>272</b>	<b>Caliope</b> — 81197	<b>116</b>	<b>Dering</b> — 98332	<b>398</b>	<b>Germout</b> — 58519	<b>219</b>	<b>Jullemier</b> — 94137	<b>262</b>
<b>Baitt</b> — 93151	<b>244</b>	<b>Caliope Roller</b> — 81198	<b>116</b>	<b>Descry</b> — 97922	<b>64</b>	<b>Gilded</b> — 94690	<b>361</b>	<b>Kafka</b> — 93712	<b>36</b>
<b>Bale</b> — 93143	<b>236</b>	<b>Caliope Set</b> — 81199	<b>116</b>	<b>Dhabi</b> — 94668	<b>327</b>	<b>Ginger</b> — 99830	<b>284</b>	<b>Kahana</b> — 94096	<b>276</b>
<b>Baloo</b> — 52619	<b>378</b>	<b>Campanela</b> — 99151	<b>395</b>	<b>Diamond</b> — 93395	<b>237</b>	<b>Giraffe</b> — 54635	<b>378</b>	<b>Kahana Wide</b> — 94095	<b>276</b>
<b>Bamb</b> — 99133	<b>382</b>	<b>Canary</b> — 92839	<b>310</b>	<b>Dickens A5</b> — 93485	<b>45</b>	<b>Giraldo</b> — 92520	<b>195</b>	<b>Kandel</b> — 97912	<b>81</b>
<b>Bambu</b> — 99133	<b>396</b>	<b>Canna</b> — 94638	<b>350</b>	<b>Dickens A6</b> — 93486	<b>45</b>	<b>Glashow Eco</b> — 57256	<b>72</b>	<b>Kardon</b> — 52627	<b>184</b>
<b>Bambu</b> — 91378	<b>141</b>	<b>Canola</b> — 94053	<b>279</b>	<b>Dill</b> — 93848	<b>280</b>	<b>Gobo</b> — 94006	<b>242</b>	<b>Karen</b> — 99115	<b>390</b>
<b>Bangkok</b> — 92636	<b>186</b>	<b>Capers</b> — 93966	<b>253</b>	<b>Doha</b> — 92236	<b>200</b>	<b>Goiba</b> — 30508	<b>15</b>	<b>Karl</b> — 99122	<b>391</b>
<b>Bannon</b> — 57365	<b>78</b>	<b>Cappero</b> — 94028	<b>253</b>	<b>Doublette</b> — 91844	<b>118</b>	<b>Goiba Wh</b> — 30509	<b>15</b>	<b>Karpov</b> — 94610	<b>342</b>
<b>Banon</b> — 93880	<b>253</b>	<b>Caraway</b> — 94260	<b>249</b>	<b>Douro</b> — 91816	<b>114</b>	<b>Goiba Women</b> — 30510	<b>15</b>	<b>Kate</b> — 81116	<b>152</b>
<b>Barcelona</b> — 92669	<b>198</b>	<b>Caraway Long</b> — 94258	<b>249</b>	<b>Dozy</b> — 98113	<b>221</b>	<b>Goiba Women Wh</b> — 30511	<b>15</b>	<b>Kate Bk</b> — 81117	<b>152</b>
<b>Barium 4.0</b> — 97942	<b>94</b>	<b>Caraway Round</b> — 94259	<b>249</b>	<b>Drinky</b> — 94091	<b>276</b>	<b>Goya</b> — 91795	<b>135</b>	<b>Kathrine</b> — 92125	<b>170</b>
<b>Barley</b> — 94118	<b>274</b>	<b>Cardiff</b> — 92183	<b>172</b>	<b>Dudley</b> — 94628	<b>354</b>	<b>Graham</b> — 54734	<b>53</b>	<b>Kayl</b> — 92357	<b>202</b>
<b>Barrel</b> — 94191	<b>271</b>	<b>Caribe</b> — 51256	<b>148</b>	<b>Duha</b> — 99140	<b>393</b>	<b>Graham</b> — 54734	<b>87</b>	<b>Kaylum</b> — 91791	<b>125</b>
<b>Barter</b> — 51759	<b>156</b>	<b>Caribe White</b> — 81104	<b>148</b>	<b>Dunedin</b> — 93322	<b>234</b>				



Lambda 4.0	—	97943	0.94	Millard	—	93280	0.234	Pati	—	81153	0.141	Sablon	—	92919	0.292	Tilly	—	97095	0.71
Lamone	—	94098	0.278	Millau	—	95051	0.231	Patti	—	99116	0.392	Saffron	—	93847	0.280	Tilt Bc	—	31018	0.145
Lana	—	81122	0.150	Miller	—	93124	0.246	Paw	—	93364	0.240	Sagan	—	97077	0.95	Tilt Bt	—	31019	0.145
Lana Frost	—	81124	0.150	Milli	—	92148	0.209	Pedro	—	99275	0.397	Salinger	—	92068	0.57	Tilt Eco	—	31020	0.145
Lana White	—	81123	0.150	Millie	—	92077	0.207	Pemba	—	92931	0.304	Sally	—	81107	0.149	Tisana	—	94636	0.350
Lando	—	81190	0.128	Milo	—	92316	0.202	Pendulo	—	91970	0.133	Sally Frost	—	81108	0.149	Titus 1	—	94656	0.358
Lando Roller	—	81191	0.128	Milton	—	93476	0.51	Penrose	—	97517 / 97528 / 97529	0.97	Salvy	—	93969	0.250	Titus 2	—	94657	0.358
Langford	—	94960	0.338	Milu	—	81113	0.153	Pepe	—	94620	0.354	Samoura	—	93851	0.281	Titus 3	—	94658	0.358
Lapoint	—	81201	0.121	Milu Frost	—	81109	0.153	Pepper	—	93968	0.250	Sandra	—	99213	0.387	Titus 4	—	94659	0.358
Latte	—	94067	0.350	Minsky	—	97090	0.101	Perry	—	57253	0.84	Santana	—	92266	0.190	Titus 5	—	94670	0.358
Launay	—	94686	0.360	Miro	—	91444	0.125	Perth	—	92160	0.168	Sardagna	—	98375	0.402	Tizzy	—	92828	0.293
Lavender	—	99826	0.379	Mobby	—	93165	0.240	Pertina	—	92998	0.311	Savgrass	—	92850	0.308	Toffa	—	94066	0.350
Laver	—	94257	0.319	Modric	—	94694	0.353	Pessoa	—	93734	0.35	Schooli	—	93607	0.377	Tokev	—	93870	0.282
Lavre	—	93324	0.232	Modric L	—	94695	0.353	Peter	—	93718	0.50	Screbe	—	94729	0.243	Tomas	—	99139	0.394
Lawrence	—	94030	0.227	Monarda	—	94681	0.349	Petrelli	—	94637	0.352	Script	—	91494	0.124	Torchen	—	93267	0.243
Lea	—	51125	0.122	Monco	—	92836	0.254	Phelps	—	94772	0.347	Seattle	—	92290	0.106	Tordo	—	93593	0.28
Leaf	—	91846	0.140	Mondrian	—	93577	0.31	Phladel	—	98420	0.313	Sebastian	—	98416	0.381	Toronto	—	92568	0.198
Leavitt II	—	57940	0.73	Monet	—	91792	0.117	Phuket	—	92138	0.171	Senna	—	94782	0.355	Touch	—	51437	0.123
Leif	—	93154	0.243	Moniz	—	97950	0.105	Pichu	—	99023	0.364	Seoul	—	92257	0.200	Town	—	94629	0.356
Lello	—	91973	0.132	Montigny	—	97389	0.254	Pickled	—	93885	0.255	Serena	—	94618	0.357	Traveller	—	92674	0.182
Lemon	—	94649	0.340	Montreal	—	51348	0.120	Pietro	—	94241	0.321	Serpa	—	92069	0.52	Travelx	—	98197	0.221
Leo 1.8	—	97376	0.96	Moraes	—	93714	0.34	Pisani	—	93828	0.268	Serrat	—	91392	0.126	Travis	—	99966	0.362
Leo 2.2	—	57323	0.96	Moreto	—	94119	0.269	Pitanga	—	30500	0.255	Sesame	—	93831	0.285	Travolta	—	93314	0.233
Lergan	—	93141	0.242	Moriah	—	93799	0.36	Pitanga Wh	—	30501	0.13	Sessil	—	99155	0.389	Trencher	—	97925	0.69
Leskov	—	93370	0.236	Mosfet	—	97525 / 97541	0.97	Pitanga Women	—	30502	0.13	Shades Bpack	—	92170	0.191	Trotte	—	95103	0.224
Lesley Metallic	—	81185	0.127	Motion Backpack	—	92681	0.165	Pitanga Women Wh	—	30503	0.13	Shades Cross	—	92173	0.191	Trudy	—	93398	0.245
Lesstini	—	94110	0.250	Motion Bag	—	92521	0.165	Piyon	—	57936	0.74	Shades Plate	—	52170	0.191	Tupi	—	92167	0.180
Lewis	—	93426	0.48	Motto	—	57911	0.73	Plata	—	91008	0.120	Shakespeare	—	93789	0.37	Turim	—	92471	0.196
Lezzo	—	58517	0.53	Mounti	—	92628	0.194	Plock	—	91834	0.118	Shanghai	—	91476	0.124	Turmeric	—	53878	0.283
Lezzo	—	58517	0.75	Moura	—	92129	0.170	Poe	—	92046	0.52	Shanti	—	92827	0.293	Turtle	—	58412	0.381
Lillard	—	94770	0.324	Moussaka	—	94107	0.256	Poodle	—	51756	0.373	Shaw	—	93795	0.37	Uler	—	57338	0.104
Limardo	—	98822	0.368	Muller	—	93332	0.103	Poppins	—	51140	0.131	Shelley	—	93320	0.102	Ulrich	—	93084	0.238
Lippia	—	94780	0.282	Muller	—	93332	0.234	Poppy	—	93265	0.103	Shino	—	94025	0.265	Urban Backpack	—	92683	0.164
Lispector	—	93724	0.35	Mumbai	—	92927	0.295	Poppy	—	93265	0.234	Show	—	94550	0.332	Uruguay	—	92140	0.167
Liter	—	94679	0.343	Munich	—	92569	0.198	Portel A5	—	93730	0.28	Show Satin	—	94771	0.332	Valastro	—	94109	0.260
Logan	—	52635	0.199	Munigue	—	92322	0.179	Portel A6	—	93731	0.28	Siderot	—	94688	0.338	Valentina	—	92720	0.212
Lohan	—	98091	0.223	Muriel	—	39000	0.395	Portis	—	94630	0.359	Sign I	—	81206	0.108	Valley	—	94068	0.350
Lolla	—	98417	0.312	Mustard	—	93861	0.255	Portobello	—	94781	0.264	Sign II	—	81207	0.108	Verbena	—	93977	0.268
Lone	—	93318	0.234	Muzeul	—	92544	0.193	Puzo	—	93463	0.52	Signy	—	97348	0.97	Verbie	—	94192	0.228
Lopez	—	94857	0.214	Nadal	—	94769	0.217	Pynchon	—	92066	0.57	Silver Stripe	—	99153	0.389	Verentino	—	93892	0.272
Loren	—	92713	0.210	Nadia	—	94843	0.214	Queta	—	94250	0.337	Silveray	—	81170	0.120	Verona	—	92089	0.178
Louvre	—	91489	0.113	Naeker	—	99824	0.284	Queta soft	—	94256	0.337	Simon 8Gb	—	97434	0.337	Versailles	—	81146	0.113
Luka	—	94615	0.342	Nampula	—	92933	0.300	Quiver	—	94093	0.276	Sinatra	—	51837	0.124	Vibration	—	97923	0.66
Lumina X	—	97945	0.92	Napoli	—	92935	0.295	Ragnar	—	94602	0.334	Singapore	—	98418	0.313	Victoria	—	92415	0.296
Lunar	—	92164	0.186	Nate	—	53197	0.245	Raise	—	94646	0.326	Siza	—	51935	0.158	Viena	—	92179	0.188
Lunkina	—	94768	0.322	Natura	—	91647	0.134	Raldic	—	93371	0.231	Siza	—	51935	0.231	Vigo	—	92144	0.167
Luton	—	98414	0.312	Naturel	—	94683	0.321	Raman Bk	—	57905	0.92	Slater	—	91843	0.92	Vila	—	91960	0.132
Lycka	—	94761	0.321	Neeson	—	98093	0.223	Ravioli	—	94102	0.263	Sketch	—	94062	0.263	Ville	—	92824	0.298
Lyme	—	91338	0.126	Neo	—	81001	0.110	Recicla	—	91290	0.141	Slider	—	94242	0.141	Ville	—	92824	0.403
Lynne	—	94056	0.278	Nero	—	94307	0.216	Reds	—	98059	0.223	Smartpepper	—	93989	0.257	Vivre	—	93392	0.241
Lyon	—	92320	0.178	Neruda	—	93275	0.26	Redy	—	57362	0.98	Smith	—	93308	0.98	Volter	—	81014	0.139
Lyze II	—	92725	0.218	Nerval	—	93270	0.32	Reflask 500	—	94913	0.218	Snead	—	94238	0.218	Wagner	—	93341	0.239
Macabeu	—	94193	0.272	Nesbit II	—	54743	0.53	Regent	—	92414	0.296	Sobral	—	99141	0.296	Wallis	—	97366	0.104
Mace	—	93845	0.260	Nesbit II	—	54743	0.87	Reina	—	93850	0.264	Solberg	—	94240	0.333	Warhol	—	51836	0.115
Macy	—	92854	0.310	New Star Eco	—	31022	0.145	Renewal Battery	—	97094	0.89	Sow	—	94239	0.319	Warmy	—	99071	0.288
Magnet	—	97920	0.68	Newton II	—	57312	0.98	Renewal Charger	—	97093	0.89	Spacio	—	52675	0.176	Wass	—	81000	0.127
Magnum	—	94022	0.367	Nicholas	—	99143	0.393	Reno	—	99043	0.391	Speare	—	91969	0.133	Wass Touch	—	81005	0.123
Makarova	—	94765	0.321	Nicolaus	—	94446	0.102	Repairuse Backpack	—	92080	0.174	Spice 380	—	94099	0.267	Watters	—	93269	0.41
Malbec	—	94117	0.275	Nicolaus	—	94446	0.246	Repairuse Bag	—	92078	0.205	Spice 700	—	94079	0.267	Wave Cc	—	31011	0.144
Malte	—	94115	0.274	Nicole	—	81010	0.137	Repairuse Cooler	—	98427	0.315	Spirited	—	97205	0.364	Wave Frost	—	31012	0.144
Malvia	—	93975	0.252	Ninja	—	94036	0.226	Repairuse Sports	—	92079	0.174	Split	—	94038	0.227	Wave Mm	—	31010	0.144
Manore	—	58315	0.400	Nisa	—	92274	0.201	Rhombus	—	51932	0.157	Sporty	—	94633	0.338	Wayne	—	92732	0.208
Manaus	—	92163	0.186	Noah	—	94608	0.348	Rhombus	—	51932	0.373	Stain	—	81208	0.373	Weida	—	92719	0.210
Manolo	—	99427	0.401	Norre Bottle	—	94662	0.329	Ringbolt	—	93368	0.238	Stella	—	99147	0.395	Weinberg	—	97527 / 97543	0.97
Maputo	—	92929	0.304	Norre Tumbler	—	94661	0.329	Ringord	—	93427	0.44	Stephenie	—	53565	0.376	Wellington	—	92087	0.183
Marbella	—	92938	0.197	Norris	—	94032	0.228	Rio	—	94059	0.44	Steven	—	57154	0.98	Werner	—	94666	0.348
Marcconi	—	57939	0.76	Note	—	92283	0.172	Riordan	—	92067	0.57	Stiller	—	94301	0.216	Wharf	—	92902	0.296
Mare	—	91434	0.129	Nurmi	—	94619	0.360	Rissani	—	92936	0.301	Stitch	—	93356	0.201	Whidy	—	94953	0.219
Maresia	—	92513	0.403	Odin	—	94603	0.331	Rizzoli	—	51738	0.157	Stooky	—	93421	0.51	Wild	—	94040	0.228
Margot	—	92741	0.213	Odin	—	94622	0.359	Rizzoli	—	51738	0.374	Stork	—	99123	0.382	Wilkins	—	97341	0.79
Maria	—	99138	0.394	Olaf Soft	—	81192	0.131	Roberto	—	99109	0.391	Stork	—	99123	0.391	Williams	—	94669	0.327
Marie	—	92721	0.211	Olympia	—	92276	0.184	Roberts	—	94306	0.216	Strada	—	98180	0.216	Willis	—	92724	0.209
Marjoram	—	94261	0.251	Olympia Plate	—	52276	0.184	Rocco	—	92626	0.184	Stratford	—	92499	0.184	Wiltz	—	9216	

	<b>MOCHILAS</b>	Pág. 6
	<b>MALAS</b>	Pág. 48
	<b>BOLSAS E MALAS ESPORTIVAS</b>	Pág. 56
	<b>NECESSAIRES</b>	Pág. 62
	<b>BOLSA TÉRMICA</b>	Pág. 68
	<b>PASTAS</b>	Pág. 74
	<b>GARRAFAS</b>	Pág. 76
	<b>COPOS E CANECAS</b>	Pág. 104
	<b>ESCRITÓRIO</b>	Pág. 120
	<b>CANETAS SUSTENTÁVEIS</b>	Pág. 152
	<b>CANETAS PLÁSTICAS</b>	Pág. 158
	<b>CANETAS SEMI-METAL</b>	Pág. 162
	<b>CANETAS METÁLICA</b>	Pág. 168
	<b>ESTOJOS</b>	Pág. 182
	<b>CHAVEIROS</b>	Pág. 184
	<b>DIVERSOS</b>	Pág. 190
	<b>KIT CHURRASCO</b>	Pág. 192
	<b>KIT QUEIJO</b>	Pág. 198
	<b>LANCHEIRAS</b>	Pág. 202
	<b>GUARDA-CHUVA</b>	Pág. 204

## MOCHILAS







### **MC380**

**Mochila em poliéster com porta notebook e alça de mão na lateral**

Dimensões: 49x26x17cm

Peso unit.: 0,834kg

## MOCHILAS



### MC370

**Mochila em poliéster com porta notebook e conector USB**

Dimensões: 45x28x12cm

Peso unit.: 0,622kg



### **MC360**

**Mochila e Pasta com porta notebook**

Dimensões: 40x29x10,5cm

Peso unit.: 0,818kg



## MOCHILAS



### MC430

#### Mochila e pasta com porta notebook

Dimensões: 44x31x11cm

Peso unit.: 0,410kg



## MC221

### Mochila e Pasta com porta notebook

Dimensões: 43x32x10cm

Peso unit.: 0,810kg

## MOCHILAS



### MC222

**Mochila em nylon com porta notebook**

Dimensões: 31x45x9cm

Peso unit.: 0,650kg





### **MC223**

**Mochila em poliéster com porta notebook**  
Dimensões: 31x45x9cm  
Peso unit.: 0,660kg

## MOCHILAS



### MC400

**Mochila em poliéster com porta notebook**

Dimensões: 49x34x19cm

Peso unit.: 0,908kg



## MC209

**Mochila executiva robusta com porta notebook**

Dimensões: 47x31x22cm

Peso unit.: 1,3kg



## MOCHILAS



### MC206

**Mochila executiva com porta notebook**

Dimensões: 44x30x18cm

Peso unit.: 0,900kg



### **MC205**

**Mochila executiva com bolso térmico e porta notebook**

Dimensões: 50x35x25cm

Peso unit.: 0,880kg

## MOCHILAS



### MC260

**Mochila executiva com rodinhas  
e porta notebook**

Dimensões: 31x18x43 cm

Peso unit.: 1,720 kg





## **MC204**

**Mochila executiva com rodinhas  
e porta notebook**

Dimensões: 45x33x20cm

Peso unit.: 2,012kg

# MOCHILAS





### **MC340**

**Mochila em poliéster com porta notebook e cadeado com segredo**

Dimensões: 43x29,5x15,5cm

Peso unit.: 0,530kg



# MOCHILAS





### **MC538**

**Mochila em poliéster com porta notebook e cadeado com segredo**

Dimensões: 45x14x28cm

Peso unit.: 0,680kg

# MOCHILAS







## MC240

**Mochila antifurto com porta notebook**

Dimensões: 44x30x11 cm

Peso unit.: 0,725kg



## MC295

**Mochila em poliéster com porta notebook**

Dimensões: 45x29,5x14cm

Peso unit.: 0,392kg



## **MC290**

### **Mochila em poliéster**

Dimensões: 14x38x30 cm

Peso unit.: 0,330kg



## MOCHILAS



### MC300

**Mochila em poliéster**

Dimensões: 42x32x13cm

Peso unit.: 0,410kg



### **MC305**

**Mochila em poliéster com porta notebook**

Dimensões: 46,5x31x13cm

Peso unit.: 0,436kg



**MC310**

**Mochila em poliéster com porta notebook**

Dimensões: 39x29x11cm

Peso unit.: 0,512kg





### **MC320**

**Mochila em poliéster com porta notebook e conector USB**

Dimensões: 39x27,5x11cm

Peso unit.: 0,504kg

## MOCHILAS



### MC212

**Mochila em nylon com porta notebook**

Dimensões: 44,5x30x15cm

Peso unit.: 0,590kg



### **MC213**

**Mochila em nylon com porta notebook**

Dimensões: 47x31x20cm

Peso unit.: 0,490kg



## MOCHILAS



### MC214

**Mochila em nylon com porta notebook**

Dimensões: 45x28x12cm

Peso unit.: 0,500kg



## MC215

**Mochila em nylon com porta notebook**

Dimensões: 45x29x18cm

Peso unit.: 0,480kg

## MOCHILAS



### MC220

**Mochila em poliéster com porta notebook**

Dimensões: 50x30x11cm

Peso unit.: 0,420kg





### **MC230**

**Mochila em poliéster com porta notebook**

Dimensões: 45x28x13cm

Peso unit.: 0,500kg

## MOCHILAS



### MC203

**Mochila em poliéster com porta notebook**

Dimensões: 44x31x18cm

Peso unit.: 0,527kg



## MC250

**Mochila em poliéster com porta notebook**

Dimensões: 50x30x17cm

Peso unit.: 0,790kg



## MOCHILAS



### MC330

Mochila em poliéster com porta notebook

Dimensões: 42,5x28,5x15cm

Peso unit.: 0,368kg



### **MC410**

**Mochila em poliéster com porta notebook e conector USB**

Dimensões: 44x28,5x13cm

Peso unit.: 0,458kg

## MOCHILAS



### MC420

**Mochila em poliéster com porta notebook**  
Dimensões: 44x29,5x17,5cm  
Peso unit.: 0,422kg





### **MC211**

**Mochila em poliéster com porta notebook**  
Dimensões: 44x31x11 cm  
Peso unit.: 0,348 kg

## MOCHILAS



### MC270

**Mochila em poliéster com bolso lateral**

Dimensões: 40x28x14cm

Peso unit.: 0,310 kg



## MC280

### Mochila dobrável em poliéster

Dimensões: 46x19,5x14cm

Dimensões produto dobrado: 21x20x5cm

Peso unit.: 0,250kg



## MOCHILAS



### **MC350**

**Mochila em poliéster com porta notebook**

Dimensões: 43x29,5x12cm

Peso unit.: 0,568kg



## MC440

**Mochila em poliéster**  
Dimensões: 30x16,5x5,0cm  
Peso unit.: 0,140kg







## MV800

### Mala de viagem pequena

Dimensões aproximada com rodas e alça: 55x22x35cm  
Peso unit.: 2,750kg

# MALAS





## **MV900**

**Mala de viagem pequena dobrável**  
Dimensões aproximada: 55x9x40cm  
Peso unit.: 2,300kg





## MV700

### Mala de viagem pequena

Dimensões: 37x23x52 cm  
Peso unit.: 2,300kg



## MV600

### Mala viagem pequena

Dimensões com rodas e alça: 55x22x35cm  
Peso unit.: 2,750kg

## MALAS



### **MV620**

#### **Mala viagem pequena**

Dimensões com rodas e alça: 55x22x35cm  
Peso unit.: 2,750kg





## MV610

### Mala viagem média

Dimensões com rodas e alça: 66x25x45cm

Peso unit.: 3.375kg

## BOLSAS E MALAS ESPORTIVAS





### **ME188**

#### **Mala esportiva em poliéster**

Dimensões: 49x23,5x28cm

Peso unit.: 0,390kg



### **ME500**

#### **Mala esportiva em poliéster**

Dimensões: 30x24x53cm

Peso unit.:0,500kg



## BOLSAS E MALAS ESPORTIVAS



**ME520**

**Mala esportiva em poliéster**

Dimensões: 50x28x22cm

Peso unit.: 0,540kg



## **ME510**

**Mala esportiva em poliéster**

Dimensões: 48,5x28x24cm

Peso unit.: 0,352kg

## BOLSAS E MALAS ESPORTIVAS



### **BP2000**

**Bolsa em nylon**

Dimensões: 44,5x30x13cm

Peso unit.: 0,240kg



### **BTN001**

**Sacola TNT 100gr, alça inteira 60cm**

Dimensões: 41,5x37,5cm

Peso unit.: 0,042kg





### **BP0002**

#### **Mochila Saco em poliéster com bolso**

Dimensões: 43x32cm

Peso unit.: 0,050 kg



### **BP0001**

#### **Mochila saco em poliéster sem bolso**

Dimensões: 40,5x35cm

Peso unit.: 0,025kg

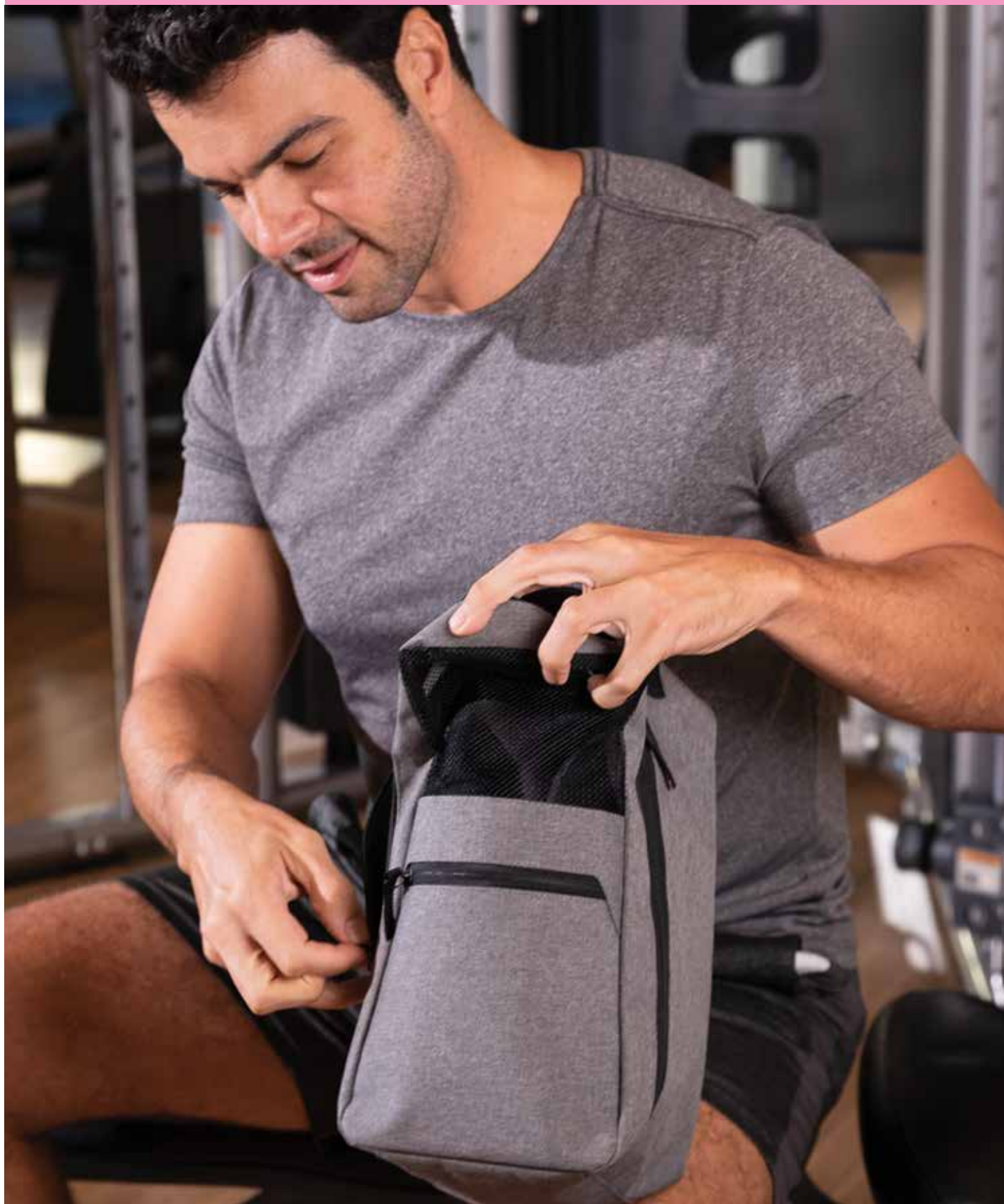



**PT1050**

**Porta tênis em poliéster**

Dimensões: 31x17x15cm

Peso unit.: 0,170kg



## NECESSAIRES



### NE150

#### Necessaire em Tyvek® e papel kraft com alça na lateral

Dimensões: 23x12x10cm

Peso unit.: 0,066kg

Tyvek® é um material 100% sintético feito de fibras de polietileno trançado de alta densidade. Leve, durável e respirável, porém resistente a água, abrasão, penetração bacteriana e o tempo.



### NE200

#### Necessaire em couro sintético

Dimensões: 21,4x12,7x9,8cm

Peso unit.: 0,116kg



**NE202**

**Necessaire em couro sintético**

Dimensões: 20,4x13,5x5,0cm  
Peso unit.: 0,063kg

---



**NE201**

**Necessaire em couro sintético e nylon**

Dimensões: 22,9x13,7x9,5cm  
Peso unit.: 0,135kg



**NE090**

**Necessaire cursor duplo em poliéster**

Dimensões: 27x18x15 cm

Peso unit.: 0,150kg



**NE100**

**Necessaire cursor duplo em poliéster**

Dimensões: 27x18x15 cm

Peso unit.: 0,150kg





**NE101**

**Necessaire poliéster e couro sintético**

Dimensões: 18x25x11cm

Peso unit.: 0,164kg



**NERU613**

**Necessaire em poliéster com bolso na frente e no verso com divisórias interna**

Dimensões: 20x24x10cm

Peso unit.: 0,226kg

## BOLSA TÉRMICA





**BT306**

**Mochila térmica em poliéster 14 litros**

Dimensões: 42x24,6x14,5cm

Peso unit.: 0,286kg



## BOLSA TÉRMICA



### BT300

Bolsa térmica em poliéster 25 litros  
Dimensões: 39x26x26cm  
Peso unit.: 0,510kg



### BT305

Bolsa térmica em poliéster 25 litros  
Dimensões: 39x26x26cm  
Peso unit.: 0,510kg



### BT303

#### Bolsa térmica em poliéster 16 litros

Dimensões: 33x32x16cm

Peso unit.: 0,450kg



### BT301

#### Bolsa térmica em poliéster 12 litros

Dimensões: 21x26x21cm

Peso unit.: 0,360kg



## BOLSA TÉRMICA



### BT304

#### Bolsa térmica em poliéster 10 litros

Dimensões: 25x20x35 cm

Peso unit.: 0,350kg



### BT302

#### Bolsa térmica com banqueta 10 litros

Dimensões: 42,5x29x35cm

Peso unit.: 1,500kg





**BT307**

**Bolsa térmica em poliéster 4 litros**

Dimensões: 22x25x14cm

Peso unit.: 0,180kg



**BT308**

**Bolsa térmica conservadora em nylon 6,5 litros**

Dimensões: 44,5x13,0x30,0cm

Peso unit.: 0,267 kg





### PA110

#### Pasta executiva p/ notebook

Dimensões: 40x29x5cm

Peso unit.: 0,380kg



### PA120

#### Pasta para notebook em poliéster

Dimensões: 40x26,5x2cm

Peso unit.: 0,220kg



## GARRAFAS





### **GA6700**

**Garrafa aço inox parede dupla 450 ml com infusor e visor de temperatura digital na tampa, conserva a temperatura quente ou fria**

Dimensões: 22xø6,3cm

Peso unit.: 0,258kg

## GARRAFAS







### **GA6750**

**Garrafa aço inox parede dupla 450 ml com infusor, conserva a temperatura quente ou fria**  
Dimensões: 22xø6,3cm  
Peso unit.: 0,258kg

## GARRAFAS



### **GA6800**

**Garrafa de bambu e aço inox parede dupla  
400 ml com infusor, conserva a temperatura  
quente ou fria**

Dimensões: 20,5xø8cm

Peso unit.: 0,300kg



### **GA4700**

**Garrafa aço inox parede dupla 500 ml,  
conserva a temperatura quente ou fria**

Dimensões: 24xø7cm

Peso unit.: 0,640kg



## GARRAFAS



### **GA7000**

**Garrafa de vidro borossilicato de 600 ml,  
tampa de bambu com alça tipo corda,  
resistente à temperatura de até 320°C**

Dimensões: 23,7xø6,5cm

Peso unit.: 0,308kg



### **GA7100**

**Garrafa de vidro borossilicato parede dupla  
360 ml com infusor, tampa de bambu com alça  
tipo corda, conserva a temperatura quente  
e frio, até 320°C**

Dimensões: 22,4xø6,4cm

Peso unit.: 0,446kg

## GARRAFAS







### **GA6100**

**Garrafa aço inox parede dupla 500 ml,  
conserva a temperatura quente ou fria**

Dimensões: 22xØ7,2cm

Peso unit.: 0,285kg

## GARRAFAS





### **GA7300**

**Garrafa aço inox parede dupla 400 ml com apoio para celular na tampa, conserva a temperatura quente ou fria**

Dimensões: 21xø6,5cm

Peso unit.: 0,255kg



## GARRAFAS



### **GA7450**

**Garrafa aço inox parede dupla de 500 ml com suporte para celular na tampa, conserva a temperatura quente ou fria**

Dimensões: 20,5xø7cm

Peso unit.: 0,265kg



### **GA7400**

**Garrafa aço inox parede dupla 500 ml com suporte para celular na tampa, conserva a temperatura quente ou fria**

Dimensões: 20,5xø7cm

Peso unit.: 0,265kg

## GARRAFAS



### **GA7200**

**Garrafa aço inox parede dupla 500 ml,  
conserva a temperatura quente ou fria**  
Dimensões: 25xø7cm  
Peso unit.: 0,337kg





### **GA2955**

**Garrafa aço inox parede dupla 750 ml,  
conserva a temperatura quente ou fria**

Dimensões: 26,5xØ8,4cm

Peso unit.: 0,400kg

## GARRAFAS



### GA4600M

**Garrafa aço inoxidável 750 ml**

Dimensões: 27xØ7,4cm

Peso unit.: 0,185kg



### GA6300

**Garrafa aço inoxidável 750 ml**

Dimensões: 26xØ8cm

Peso unit.: 0,280kg



## **GA4600**

**Garrafa aço inoxidável 750 ml**

Dimensões: 27xø7,4cm

Peso unit.: 0,185kg



## GARRAFAS



### **GA5500**

**Garrafa aço inoxidável 700 ml**  
Dimensões: 27cmXØ7,4cm  
Peso unit.: 0,260kg



### **GA0132**

**Garrafa aço inox 750 ml com mosquetão**

Dimensões: 23,0xø7,0cm

Peso unit.: 0,223kg



### **GA5100**

**Garrafa de alumínio de 600ml**

Dimensões 20xø7,5cm

Peso unit.: 0,160kg

## GARRAFAS

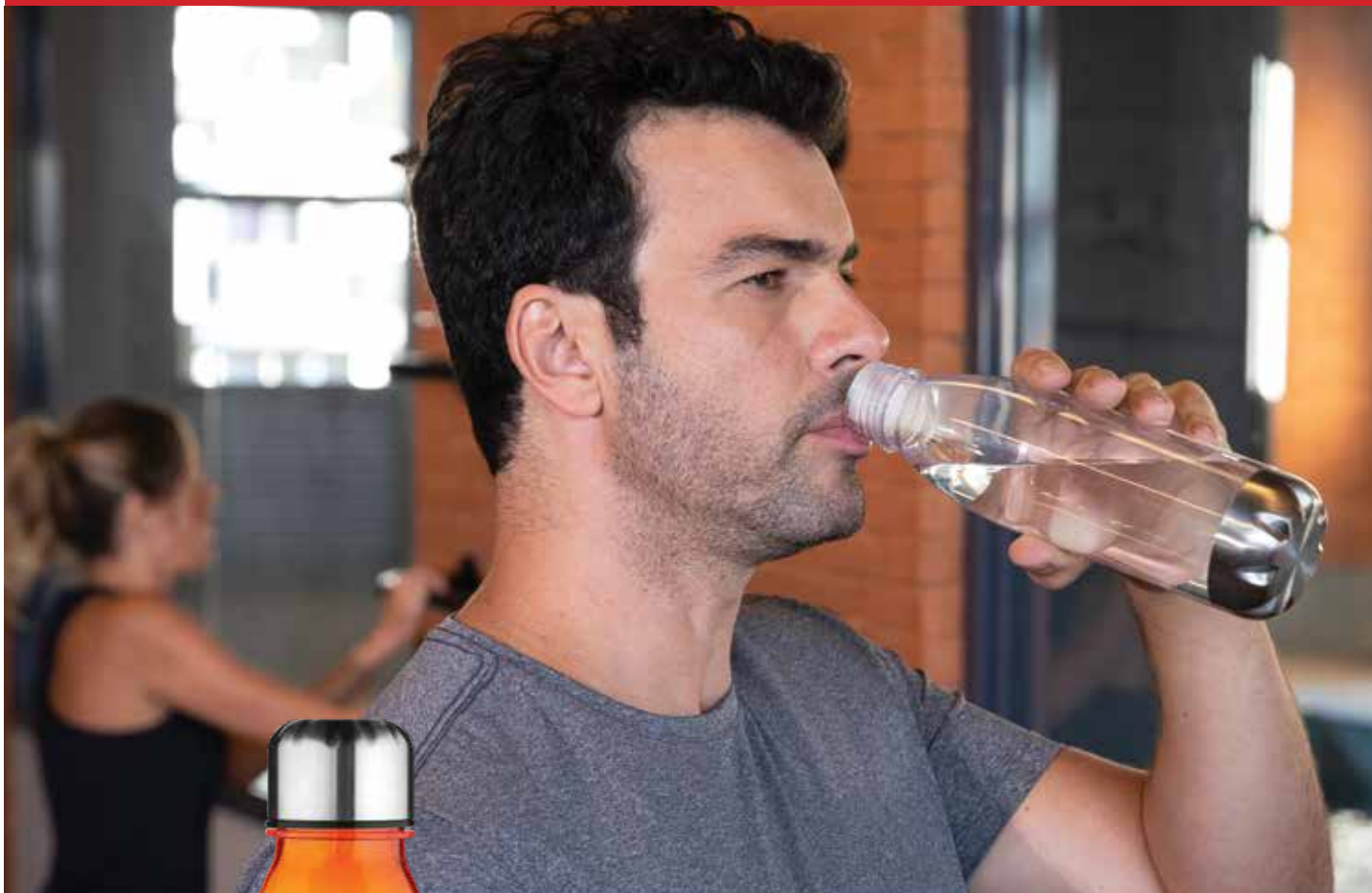

**GA4500**

**Garrafa plástica 700 ml**

Dimensões: 25xø7,4cm

Peso unit.: 0,096kg





**ECO** 



**GA7500**

**Garrafa RPET\* 500ml com alça e tampa de metal**

Dimensões: 19,7xø6,5cm

Peso unit.: 0,092kg

\*RPET: Tereftalato de polietileno reciclado

## GARRAFAS



### GA2000

Garrafa plástica 750 ml com infusor

Dimensões: 25,0xø7,0cm

Peso unit.: 0,160kg



### GA3000

Garrafa plástica 700 ml

Dimensões: 23xø7cm

Peso unit.: 0,120kg



### **GA5300**

**Garrafa plástica 700 ml  
com porta gelo e canudo**

Dimensões: 26xø7,50cm

Peso unit.: 0,100kg



### **GA5700**

**Garrafa em silicone retrátil 500 ml**

Dimensões: expandida 22,5xø7cm /  
retraída 12,5xø7cm

Peso unit.: 0,210kg



## GARRAFAS



### GA4100

**Garrafa plástica 600 ml com porta pílulas**

Dimensões: 23,0xø7,5cm

Peso unit.: 0,130kg



### GA3100

**Garrafa plástica 700 ml**

Dimensões: 27,5xø7cm

Peso unit.: 0,286kg



### **GA4000**

**Garrafa plástica 600 ml**

Dimensões: 23,0xø7,0cm

Peso unit.: 0,138kg

## GARRAFAS



**GA6025**

**Garrafa plástica 600 ml com infusor**

Dimensões: 25,0xø6,4x21cm

Peso unit.: 0,120kg





### **GA5000**

#### **Garrafa coqueteleira 720 ml**

Dimensões: 24,4xø10,2cm  
Peso unit.: 0,250kg



### **GA5800**

#### **Garrafa plástica 1500 ml**

Dimensões: 26xø10cm  
Peso unit.: 0,200 kg



### **GA5900**

#### **Garrafa plástica 1500 ml com bico rosqueável**

Dimensões: 31xø10cm  
Peso unit.: 0,240 kg



**CA9000**

**Caneca aço inox parede dupla  
450 ml, conserva a temperatura  
quente ou fria**

Dimensões: 21xø7,3cm

Peso unit.: 0,290kg



### CA8300

**Caneca aço inox parede dupla 450 ml,  
conserva a temperatura quente ou fria**

Dimensões: 21xø7,3cm

Peso unit.: 0,290kg



## COPOS E CANECAS



### CA9100

**Caneca aço inox 450 ml com tampa plástica**

Dimensões: 16,3x 7cm

Peso unit.: 0,176kg



### CA8400

**Caneca inox parede dupla 350 ml, conserva a temperatura quente ou fria**

Dimensões: 14,1x9cm

Peso unit.: 0,225kg



**CA8200**

**Caneca em aço inox 350ml, alça de mão plástica tipo mosquetão e tampa com vedação**

Dimensões: 12,3x8cm

Peso unit.: 0,240kg





### CA8100

**Caneca aço inox parede dupla antiqueda 260 ml,  
conserva a temperatura quente ou fria**

Dimensões: 13x8,5cm

Peso unit.: 0,270kg



### CA0150

**Caneca plástica e aço inox 400 ml**

Dimensões: 12,5x9,0cm

Peso unit.: 0,254kg



**CA0150T**

**Caneca plástica 400 ml  
com inox na parte interna**

Dimensões: 12,5x9cm

Peso unit.: 0,254kg



### CA0160

**Caneca plástica 300 ml  
com inox na parte interna**

Dimensões: 11x9cm

Peso unit.: 0,140kg



## COPOS E CANECAS



**C08200**

**Copo plástico antiqueda 500 ml**

Dimensões: 22xø8,5cm

Peso unit.: 0,290kg



### C08500

#### Copo de silicone retrátil 500 ml

Dimensões: Expandido 18xø8,5cm

Dimensões: Retraído 7,3xø8,5cm

Peso unit.: 0,180kg



### C08350

#### Copo de silicone retrátil 350 ml

Dimensões: Expandido 14,3xø8,5cm

Dimensões: Retraído 6,2xø8,5cm

Peso unit.: 0,125kg

## COPOS E CANECAS



**C08900**

**Copo plástico e fibra de arroz 550 ml**

Dimensões: 16x9øcm

Peso unit.: 0,086kg



**C08950**

**Copo plástico e fibra de arroz 350 ml**

Dimensões: 11x9øcm

Peso unit.: 0,060kg





**C0019**

**Copo plástico e fibra de bambu 450 ml**

Dimensões: 14xø8cm

Peso unit.: 0,100kg



**C0020**

**Copo plástico e fibra de bambu 450 ml**

Dimensões: 14xø8cm

Peso unit.: 0,100kg



**C06021**

**Copo plástico com canudo 470ml**

Dimensões: 18,5x10cm

Peso unit.: 0,200kg



**C08100**

**Copo de plástico 500 ml  
com esmecedor de frutas**

Dimensões: 23x7cm

Peso unit.: 0,120kg



**C08600**

**Copo plástico 600ml com tampa e canudo**

Dimensões: Ø10cm, 19,5cm altura

Peso unit.: 0,110kg



**C08700**

**Copo plástico 550ml com glitter**

Dimensões: Ø10x16cm

Peso unit.: 0,155kg



## COPOS E CANECAS



**C08800**

**Copo plástico 600ml com tampa e canudo**

Dimensões: Ø10x16cm

Peso unit.: 0,095Kg



**C017266**

**Copo plástico 800 ml para salada com recipiente para molho e garfo**

Dimensões: 19xØ13cm

Peso unit.: 0,076kg



**C07000**

**Copo plástico parede dupla 400 ml**

Dimensões: 14,5xø9cm

Peso unit.: 0,146kg



**CN002**

**Kit canudo reto, curvo e escova 3 peças**

Dimensões: 21,5x0,6cm

Peso unit.: 0,040kg



**GT8924**

**Kit canudo de silicone e escova 2 peças**

Dimensões: 20xø1cm

Peso unit.: 0,025 kg



### **CJ40024**

**Kit escritório antibacteriano, contendo:**  
**1 Bloco de anotações capa material PP;**  
**1 Caneta plástica retrátil;**  
**1 Copo plástico 350ml com tampa.**

Dimensões: 15x12x10cm

Peso unit.: 0,218kg





### **BL028**

**Kit Escritório antibacteriano, contendo:  
1 Bloco de anotações capa em material PP  
com suporte para canetas;  
1 Caneta plástica retrátil.**

Dimensão: 14x9x0,7cm  
Peso unit.: 0,067kg

## ESCRITÓRIO



ANTI  
BACTERIANO



### CJ40025

Kit escritório antibacteriano, contendo:

- 1 Caneta plástica retrátil;
- 1 Lapiseira plástica retrátil;
- 1 Régua plástica 15cm;
- 1 Borracha.

Dimensões: 16,5x3cm  
Peso unit.: 0,050kg



ANTI  
BACTERIANO



### **CAD360**

**Kit Escritório antibacteriano, contendo:  
1 Caderno de anotações capa material PP  
com suporte para canetas;**

**1 Caneta plástica retrátil**

Dimensões: 21x14,5x0,7cm

Peso unit.: 0,160kg





## CAD370

Kit escritório, contendo:

1 Caderno de anotações com capa material PP e café e suporte para caneta;

1 Caneta material plástico e café.

**PRODUTOS COM AROMA DE CAFÉ.**

Dimensões: 21x14,5x0,7cm

Peso unit.: 0,190kg



### **BL029**

**Kit escritório, contendo:**

**1 Bloco de anotações capa material PP e café com suporte para canetas;**

**1 Caneta material plástico e café.**

**PRODUTOS COM AROMA DE CAFÉ.**

Dimensão: 14x9x0,7cm

Peso unit.: 0,065kg





**CAD007**

**Caderno de anotações capa de bambu com elástico**

Dimensões: 20,5x13,1cm

Peso unit.: 0,265kg





### CAD380

**Kit escritório, contendo:  
Caderno de anotações capa bambu  
com elástico e suporte para caneta;  
Caneta de Bambu esferográfica  
com detalhes em plástico**

Dimensões: 14x9x1,9 cm  
Dimensão caneta: 14x1,1cm  
Peso unit.: 0,100kg



### CAD390

**Kit escritório, contendo:  
Caderno de anotações capa bambu  
com elástico e suporte para caneta;  
Caneta de Bambu esferográfica com  
detalhes em metal;**

Dimensões: 18x13,5x1,9cm  
Dimensão caneta: 13,5x1,1cm  
Peso unit.: 0,180kg



## BL031

Bloco de anotações formato de cubo em papelão reciclado, contendo: 5 blocos autocolantes coloridos com 100 folhas; 5 blocos autocolantes coloridos com 20 folhas; Porta canetas; Sticky notes.

Dimensões: 9,5x9,5x9,5cm

Peso unit.: 0,306kg



### **BL032**

**Bloco de anotações em papelão reciclado, contendo:**

**5 blocos autocolantes coloridos com 25 folhas;**

**1 bloco de adesivo amarelo com 25 folhas;**

**Porta canetas;**

**Porta Retrato.**

Dimensões: 13,5x9,5x4,0cm

Peso unit.: 0,094kg



# ESCRITÓRIO





### CJ11453

**Kit Escritório, contendo:**

**1 Bloco de anotações em formato de nuvem em material plástico e fibra de trigo;**

**1 Porta clips;**

**1 Caneta plástica com fibra de trigo**

Dimensões: 10x6,5x3,2cm

Peso unit.: 0,076kg

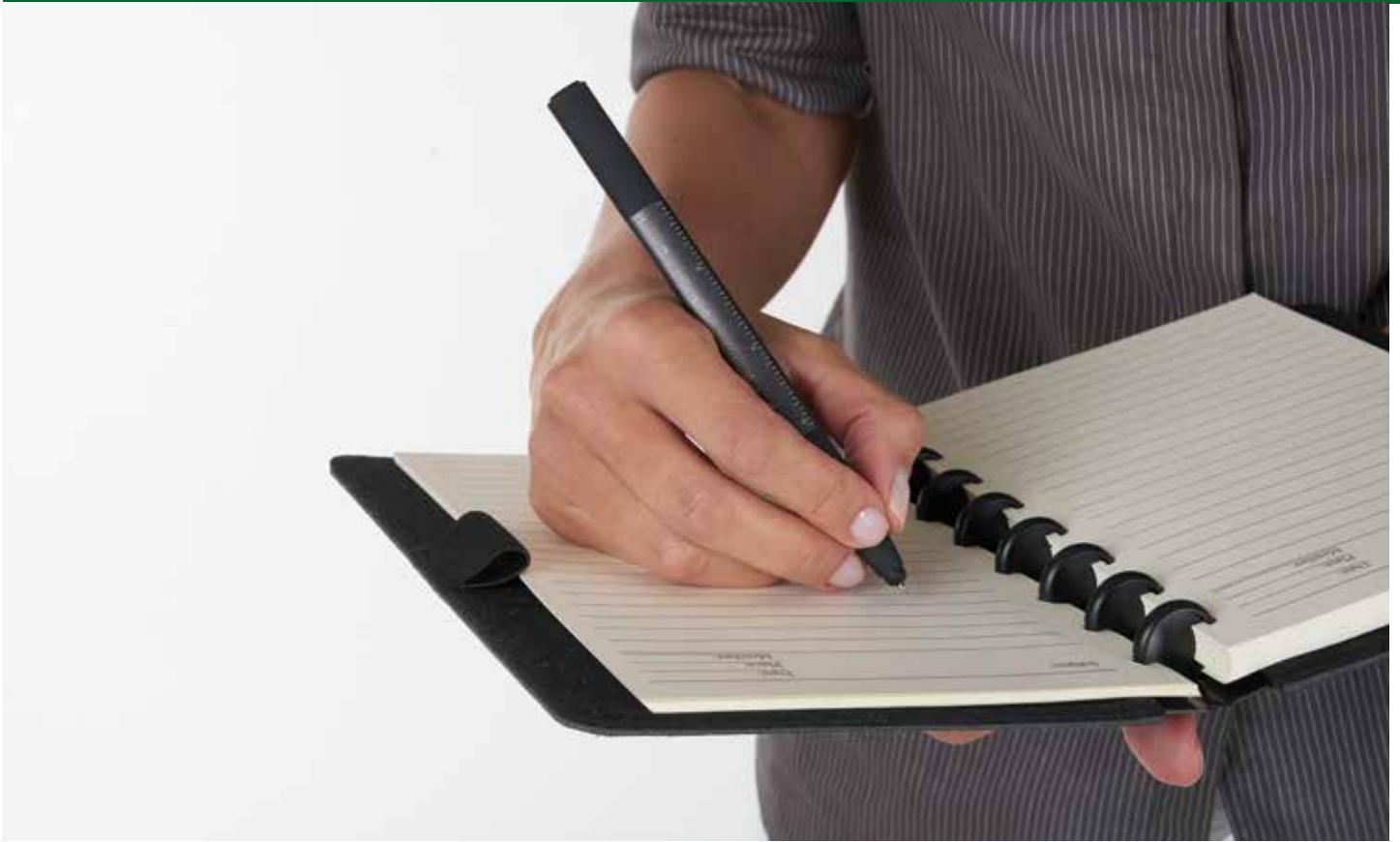



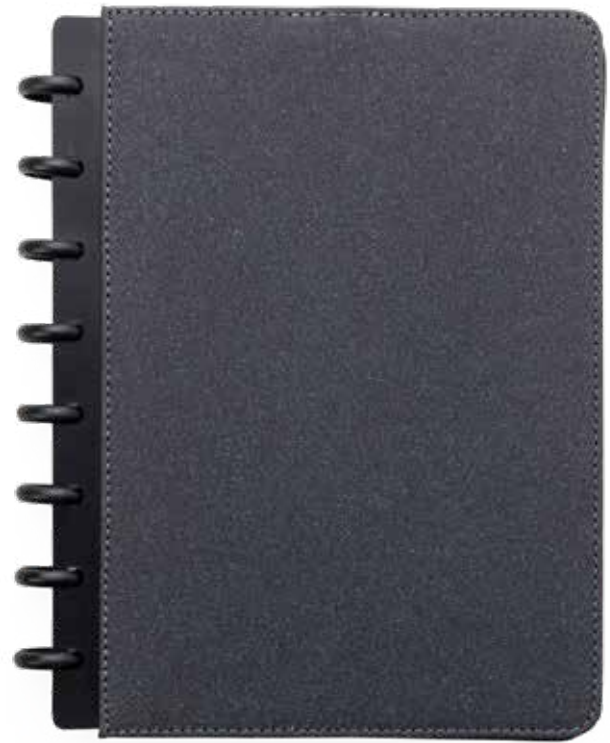

### **CAD350**

**Caderno de anotações capa dura  
com folhas destacáveis**

Dimensões: 22,3x18x2,1 cm

Peso unit.: 0,420kg



**CAD400**

**Caderno de anotações em couro reciclado com porta canetas**

Dimensões: 21,0×14,5×1,4cm

Peso unit.: 0,210kg



### CJ40035

Kit escritório, contendo:  
Bloco de anotações  
com 40 folhas pautadas bege;  
5 Blocos adesivos colorido  
com 25 folhas cada;  
Bloco de anotações adesivo  
7,5cm x 7,5cm amarelo com 25 folhas;  
1 Porta Cartão;  
1 Régua de 15cm em bambu;  
1 Apontador de lápis em bambu;  
1 Borracha;  
1 Caneta de papelão  
com detalhes em plástico;  
2 Lápis de bambu.  
Dimensões: 21x15cm  
Peso unit.: 0,319kg





## BL030

**Bloco de anotações com 200 folhas brancas e 5 blocos autocolantes colorido**

Dimensões: 8,1x8,3x2,6cm  
Peso unit.: 0,108kg



## BL026

**Bloco de anotações com sticky notes**

Dimensões: 8,0x5,3x1,2cm  
Peso unit.:0,025kg



## BL024

### Bloco de anotações com sticky notes

Dimensões: 13,5x11,5x1,2cm

Peso unit.: 0,145kg



## BL025

### Bloco de anotações com sticky notes

Dimensões: 10,5x8,0x1,2cm

Peso unit.: 0,060 kg



### BL022

#### Bloco de anotações com sticky notes

Dimensões: 16x10x2cm

Peso unit.:0,115kg



### BL023

#### Bloco de anotações com sticky notes

Dimensões: 14,4x9,4x1,0cm

Peso unit.: 0,088kg





### **CAD340**

**Caderno de anotações com elástico e porta canetas**

Dimensão: 21,4x14,5x1,5cm

Peso unit.: 0,294kg



## CAD100

### Caderno de anotações com sticky notes

Dimensões: 21x15x1,5cm  
Peso unit.: 0,270kg



## CAD330

### Caderno capa dura 96 folhas wire-o

Dimensões: 24x18x1,5cm  
Peso unit.: 0,445 kg



### **CAD110**

#### **Caderno de anotações com porta objetos**

Dimensões: 21,5x15,5x1,5cm

Peso unit.: 0,295kg



### **CAD120**

#### **Caderno de anotações com elástico suporte para celular e caneta**

Dimensões: 21x14x1,5cm

Peso unit.: 0,282kg





### CAD005

**Kit escritório, contendo:  
Caderno de anotações com elástico  
e porta canetas com 30 folhas;  
Caneta de papel reciclado esferográfica com  
detalhes em plástico.**

Dimensões: 21x14x0,4cm  
Dimensão caneta: 14x0,95cm  
Peso unit.: 0,080kg



### CAD003

**Caderno de anotações com elástico e porta canetas**

Dimensões: 14x9x2cm  
Peso unit.: 0,115kg



### CAD004

**Caderno de anotações com elástico e porta canetas**

Dimensões: 21x14x2cm  
Peso unit.: 0,230 kg



### CAD006

**Caderno de anotações com sticky notes e régua destacável**

Dimensões: 21x14x0,8cm

Peso unit.: 0,214kg



### CAD230

**Caderno com powerbank**

Dimensões: 23x17x3cm

Peso unit.: 0,610 kg





### **CAD270**

#### **Caderno de anotações com suporte porta caneta**

Dimensões: 21,3x14,3x1,5cm  
Peso unit.: 0,300kg



### **CAD280**

#### **Caderno de anotações com suporte p/ caneta e porta cartão**

Dimensões: 21x14x1,5cm  
Peso unit.: 0,300kg



**CAD260**

**Caderno de anotações com porta objetos**

Dimensões: 21,3x14,3x1,5cm

Peso unit.: 0,300kg



## PC600

**Pasta executiva com bloco de anotações**

Dimensões: 31x24x1,8m

Peso unit.: 0,476kg





## PC700

**Pasta executiva com bloco de anotações**

Dimensões: 31x23,5x2cm

Peso unit.: 0,450kg



## PC900

**Pasta executiva com bloco de anotações**

Dimensões: 31x23,8x2cm

Peso unit.: 0,480 kg



### SVT003

#### Suporte para celular com porta canetas e clips

Dimensões: 12,4x12,4x3,5cm

Peso unit.: 0,085kg



### PW001

#### Protetor de webcam 1,8X0,9cm

Dimensões: 1,8x0,9cm

Peso unit.: 0,002kg



### PW002

#### Protetor de webcam 3x1,2cm

Dimensões: 3x1,2cm

Peso unit.: 0,006 kg

## ESCRITÓRIO



### MP350

Mouse Pad em material sintético grafite e bambu, contendo:  
**porta canetas; porta Cartões; porta celular**  
Dimensões: 25x25,4x1,5cm  
Peso unit.: 0,280kg



### SVT007

**Organizador de cabos tipo carretel**  
Dimensões: 6,5xØ 2,1cm  
Peso unit.: 0,013kg



### SVT005

**Organizador de cabos emborrachado**  
Dimensões: 1,4xØ3,1cm  
Peso unit.: 0,006kg





## **SVT006**

### **Organizador flexível de cabos**

Dimensões: 3xØ7cm

Peso unit.: 0,010kg

## CANETAS SUSTENTÁVEIS



**CB47012**

**Caneta de Bambu esferográfica com  
detalhes em plástico e metal.**

**Acompanha estojo de papel**

Dimensões: 17,4x5,4x2,3cm

Peso unit.: 0,035kg



### CM0118

**Caneta metal esferográfica detalhe em bambu com estojo**

Dimensões: 14,0xØ1,2cm

Peso unit.: 0,023kg



## CANETAS SUSTENTÁVEIS



### CB22941

**Caneta Bambu esferográfica  
com detalhes em metal  
Acompanha estojo de papel**

Dimensões: 13,9x1,05cm  
Peso unit.: 0,0086kg



### CB10884-BG

**Caneta de Bambu esferográfica  
com detalhes em plástico  
Acompanha estojo de papel**

Dimensões: 14x1,1cm  
Peso unit.: 0,009kg



### **CB12948**

**Caneta de Bambu esferográfica  
com detalhes em metal  
Acompanha estojo de papel**

Dimensões: 14x1,3cm  
Peso unit.: 0,0095kg



### **CB13516**

**Caneta de Bambu esferográfica  
com detalhes em plástico e metal  
Acompanha estojo de papel**

Dimensões: 14x1,1cm  
Peso unit.: 0,009kg

## CANETAS SUSTENTÁVEIS



**CP0107C**

**Caneta de papel reciclado colorido  
esferográfica com detalhes em plástico PLA  
biodegradável**

Dimensões: 14x1,05cm  
Peso unit.: 0,0075kg





### CP0107D

**Caneta de papel reciclado esfográfica com detalhes em plástico PLA biodegradável**

Dimensões: 14x1,05cm

Peso unit.: 0,0075kg



### CPYFA2649B

**Caneta corpo em cortiça com detalhes em plástico**

Dimensões: 14xØ1,1cm

Peso unit.: 0,008kg

## CANETAS PLÁSTICAS



### CP2000B

#### Caneta plástica esferográfica retrátil

Dimensões: 14xØ0,96 cm  
Peso unit.: 0,006 kg



### CP2000

#### Caneta plástica esferográfica retrátil

Dimensões: 14xØ0,96cm  
Peso unit.: 0,006kg



### CP3000B

#### Caneta plástica esferográfica retrátil

Dimensões: 13,9xø0,96cm

Peso unit.: 0,007kg



### CP3000

#### Caneta plástica esferográfica retrátil

Dimensões: 13,9xø0,96cm

Peso unit.: 0,007kg



## CANETAS PLÁSTICAS



### CP8202

**Caneta plástica esferográfica retrátil com ponta touch, apoio e limpa tela para celular**

Dimensões: 14,7x1,1cm  
Peso unit.: 0,09 kg



### CP0302

**Caneta plástica esferográfica retrátil**

Dimensões: 14,6xø1,1cm  
Peso unit.: 0,010kg



**CP0301**

**Caneta plástica esferográfica retrátil**

Dimensões: 13,5xø0,96cm

Peso unit.: 0,007kg



**CS1111**

**Caneta semimetal esferográfica**

Dimensões: 14,4xø1,0cm

Peso unit.: 0,009kg



**CP0300B**

**Caneta plástica esferográfica retrátil**

Dimensões: 13,6xø0,97cm

Peso unit.: 0,008kg

## CANETAS SEMI-METAL







**CS5047**

**Caneta plástica esferográfica retrátil  
com apoio para celular**

Dimensões: 15,5xØ1,2 cm  
Peso unit.: 0,009 kg



**CS5062**

**Caneta plástica esferográfica retrátil**

Dimensões: 14,2xØ1,12cm  
Peso unit.: 0,009kg

## CANETAS SEMI-METAL

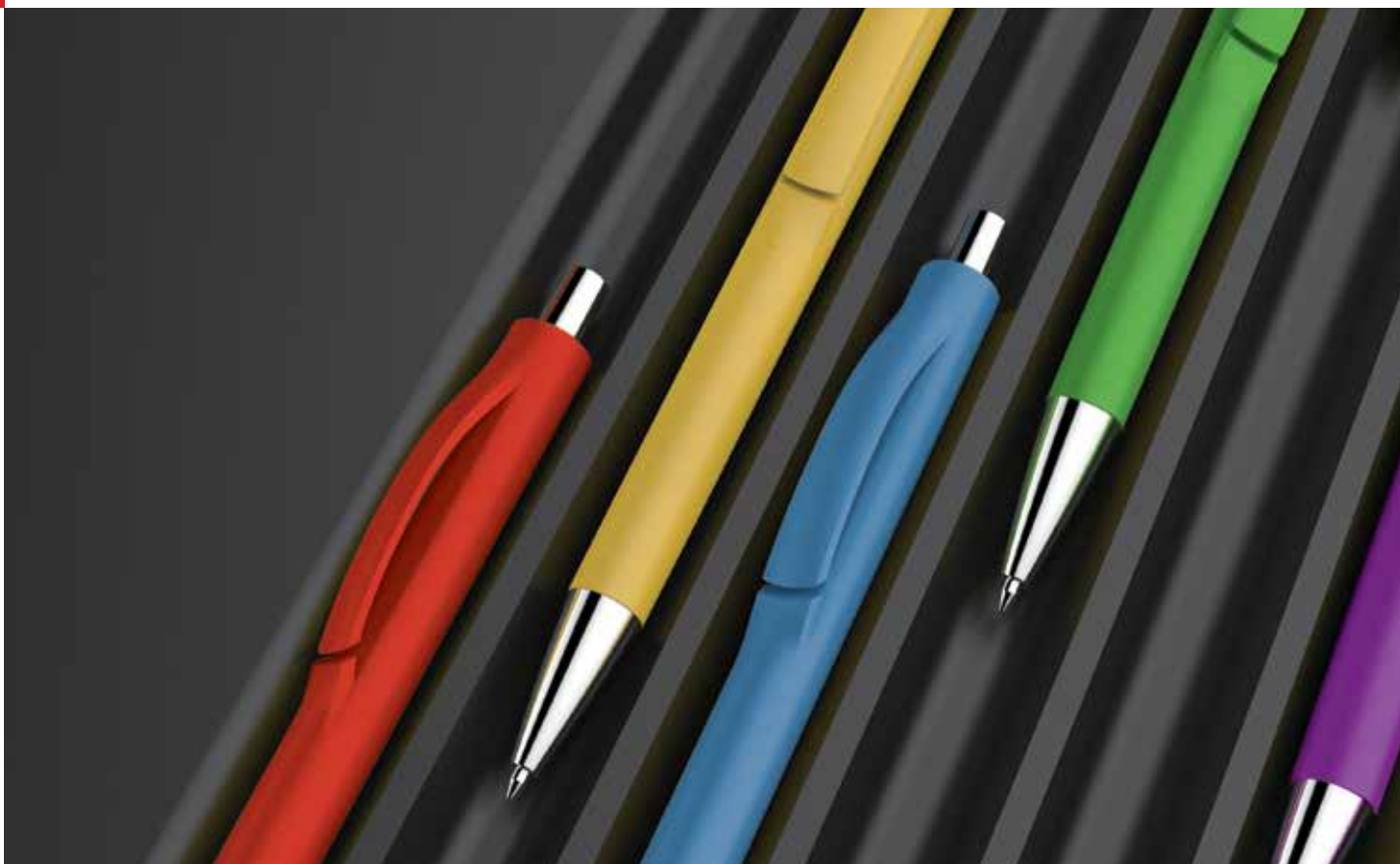

### **CS5030**

**Caneta plástica esferográfica retrátil**

Dimensões: 15xø1,2cm

Peso unit.: 0,009 kg



**CS5036**

**Caneta semimetal esferográfica retrátil**

Dimensões: 13,7xØ1,1 cm

Peso unit.: 0,009 kg



**CS5082**

**Caneta plástica esferográfica retrátil**

Dimensões: 14,8xØ1,2 cm

Peso unit.: 0,011 kg



## CANETAS SEMI-METAL



**CS1055**

**Caneta plástica esferográfica twist**

Dimensões: 14,5xØ1,2 cm

Peso unit.: 0,009 kg



**CS1056**

**Caneta semimetal esferográfica retrátil**

Dimensões: 14,7x1,1cm

Peso unit.: 0,010kg



### CS1033

#### Caneta plástica esferográfica retrátil

Dimensões: 14,9xø1,1cm  
Peso unit.: 0,008 kg



### CS1035

#### Caneta plástica esferográfica retrátil

Dimensões: 14,3xø1,3cm  
Peso unit.: 0,009kg

## CANETAS METÁLICA



**CM0118**

**Caneta metal esferográfica detalhe em bambu com estojo**

Dimensões: 14,0xø1,2cm

Peso unit.: 0,023kg





**CM0107A**

**Caneta metal esferográfica retrátil ponta touch**

Dimensões: 14,0xø1 cm  
Peso unit.: 0,019 kg



**CM0107C**

**Caneta metal esferográfica retrátil emborrachada ponta touch**

Dimensões: 14xø1cm  
Peso unit.: 0,019kg

## CANETAS METÁLICA



**CM2620**

**Caneta metal esferográfica retrátil ponta touch**

Dimensões: 14,0xø1,3cm

Peso unit.: 0,015 kg



**CM1096**

**Caneta metal esferográfica retrátil ponta touch**

Dimensões: 14xø1cm

Peso unit.: 0,015kg



**CM2640**

**Caneta metal com ferramentas e ponta touch**

Dimensões: 16,0xø1,3cm

Peso unit.: 0,015 kg



**CM1809C**

**Caneta metal esferográfica retrátil LED**

Dimensões: 15xø1,15cm

Peso unit.: 0,013kg



## CANETAS METÁLICA



**CM0108**

**Caneta metal esferográfica retrátil**

Dimensões: 14,0xø1 cm

Peso unit.: 0,016 kg



**CM17725R**

**Caneta metal esferográfica emborrachada  
ponta touch**

Dimensões: 13,5xø0,8cm

Peso unit.: 0,011kg



**CM1107S**

**Caneta metal esferográfica retrátil  
pintura áspera**

Dimensões: 14,0xø0,9cm  
Peso unit.: 0,018 kg



**CM1067**

**Caneta metal esferográfica retrátil**

Dimensões: 14,5xø1,3cm  
Peso unit.: 0,018kg

## CANETAS METÁLICA



**CM1110C**

**Caneta esferográfica em metal escrita azul**

Dimensões: 14,0xø1cm

Peso unit.: 0,022 kg



**CM1072**

**Caneta metal esferográfica retrátil**

Dimensões: 14,5xø1,3cm

Peso unit.: 0,018kg







**CM1064A**

**Caneta metal esferográfica retrátil**

Dimensões: 14,6xø1,4cm

Peso unit.: 0,022 kg



**CM1103D**

**Caneta metal esferográfica retrátil**

Dimensões: 14,2xø1,1cm

Peso unit.: 0,020kg

## CANETAS METÁLICA



**CM2630**

**Caneta metal esferográfica**

Dimensões: 14,0xø1,3cm

Peso unit.: 0,033 kg



**CM2630R**

**Caneta metal roller**

Dimensões: 14,0xø1,3cm

Peso unit.: 0,033kg



**CM0300**

**Caneta metal esferográfica**

Dimensões: 13,6xø1,1cm

Peso unit.: 0,029 kg



**CM0300R**

**Caneta metal roller**

Dimensões: 13,8xø1,1cm

Peso unit.: 0,029kg



## CANETAS METÁLICA



**CM1027S**

**Caneta metal esferográfica**

Dimensões: 14,0xø1,3cm  
Peso unit.: 0,023 kg



**CM1027SR**

**Caneta metal roller**

Dimensões: 14xø1,3cm  
Peso unit.: 0,023kg



**CM1027G**

**Caneta metal esferográfica**

Dimensões: 14,5xø1,1cm  
Peso unit.: 0,020 kg



**CM1027GR**

**Caneta metal roller**

Dimensões: 14xø1,1cm  
Peso unit.: 0,020kg

## CANETAS METÁLICA



**CM1101A**

**Caneta metal esferográfica**

Dimensões: 14,0xø1,7cm

Peso unit.: 0,022 kg



**CM1101B**

**Caneta metal esferográfica**

Dimensões: 14xø1,7cm

Peso unit.: 0,023kg





**CM1101R**

**Caneta metal roller**  
Dimensões: 14,0xø1,7cm  
Peso unit.: 0,023 kg



**CM1640**

**Caneta metal esferográfica com estojo**  
Dimensões: 14xø1,7cm  
Peso unit.: 0,048kg



**EM1640**

**Estojo de papelão para 1 caneta**

Dimensões: 17x4x2,5cm

Peso unit.: 0,018 kg



**EM0114**

**Estojo de papelão bambu print**

Dimensões: 17,4x5,4x2,3cm

Peso unit.: 0,018kg



**EM0147**

**Estojo executivo para até 2 canetas**

Dimensões: 19x7x2,5cm

Peso unit.: 0,085kg



**EM0134**

**Estojo de metal para 2 canetas**

Dimensões: 17,8x6,0x2,0cm

Peso unit.: 0,062kg



**EM0135**

**Estojo de metal para 1 caneta**

Dimensões: 17,8x3,8x2,0cm

Peso unit.: 0,055kg



# CHAVEIROS





**CH53074**

**Chaveiro de metal com detalhe em bambu**

Dimensões: 8x5cm

Peso unit.: 0,0268kg

## CHAVEIROS



### CH77010A

Chaveiro de plástico e material antibacteriano, com as funções:  
**Ponta Touch;**  
**Abridor de Garrafas;**  
**Acionador de superfícies sem o contato físico;**  
Dimensões: 10,3x0,6cm  
Peso unit.: 0,0235kg





ANTI  
BACTERIANO



**CH77010B**

Chaveiro de plástico e material antibacteriano, com as funções:

**Ponta Touch;**

**Abridor de Garrafas;**

**Aciona superfícies sem o contato físico;**

Dimensões: 10,3x0,6cm

Peso unit.: 0,0235kg

## CHAVEIROS



### CH0508

#### Chaveiro de metal e nylon

Dimensões: 8,5x3,4cm  
Peso unit.: 0,032kg



### CH0685

#### Chaveiro de metal e couro sintético

Dimensões: 10,5x3,2cm  
Peso unit.: 0,044kg



### CH0211

#### Chaveiro de metal e couro sintético

Dimensões: 9,0x2,5cm  
Peso unit.: 0,044kg



**CH6898**

**Chaveiro de metal e couro sintético**

Dimensões: 10,5x1,8cm

Peso unit.:0,034kg



**CH0510**

**Chaveiro de metal e couro sintético**

Dimensões: 12,8x3,5cm

Peso unit.: 0,054kg







### LF0200

Lanterna led com Kit Ferramentas de 15 peças

Dimensões: 23, xØ9,5 cm

Peso unit.: 0,586kg

## KIT CHURRASCO







**KC0125**

**Kit Churrasco com 4 peças**

Dimensões: 35x20x13cm

Peso unit.: 0,550kg



**KC0124**

**Kit churrasco 2 peças estojo em nylon**

Dimensões: 33,5x9x2,5cm

Peso unit.: 0,271kg

## KIT CHURRASCO



### KC0200

#### Kit Churrasco com 3 peças

Dimensões: 32x20x1,5cm

Peso unit.: 0,760kg



### KC0201

#### Kit Churrasco com 4 peças

Dimensões: 37x22,4x1,5cm

Peso unit.: 1,200kg



## **TB0200**

### **Tábua para Churrasco**

Dimensões: 32x20x1,2cm

Peso unit.: 0,537kg



## **TB0201**

### **Tábua para Churrasco**

Dimensões: 37x22,5x1,2cm

Peso unit.: 0,700kg



## KIT CHURRASCO



**KC0204**

**Kit Churrasco com 5 peças**

Dimensões: 37x22,5x1,2cm

Peso unit.: 0,650kg





**KC0205**

**Kit Churrasco com 5 peças**

Dimensões: 37x22,5x1,2cm

Peso unit.: 0,950kg



## KIT QUEIJO



### KQ262

**Kit queijo 3 peças, contendo:  
Faca, garfo e tábua**

Diâmetro da tábua: 15cm

Dimensões: 27x24x2,3cm

Peso unit.: 0,535kg





### KQ269

**Kit queijo 3 peças, contendo:  
Faca, garfo e tábua**

Diâmetro da tábua: 14cm  
Dimensões: 29,7x22,5x2,5cm  
Peso unit.: 0.432kg



### KQ270A

**Kit queijo 4 peças, contendo:  
Faca, garfo espátula e tábua**

Medidas da tábua: 20,9x13x1cm  
Dimensões: 24,2x22,7x2,2cm  
Peso unit.: 0,460kg

## KIT QUEIJO



### KV0130

#### Kit Vinho de 5 peças em estojo de cortiça

Dimensões: 4,0xø14,5 cm

Peso unit.: 0,308kg



### KV0140

#### Kit vinho 4 peças em estojo plástico modelo garrafa

Dimensões: 23cmxø6,1cm

Peso unit.: 0,224kg



**KP0025**

**Tábua para Pizzas**

Dimensões: 1,2xØ35cm

Peso unit.: 1,010kg



## LANCHEIRAS



### LC180

Lancheira com 2 compartimentos talheres e elástico

Dimensões: 10,4x10,3x18,5cm

Peso unit.: 0,395kg



## LC190

### Lancheira de silicone com 3 compartimentos

Dimensões: 27x11,5x6,5cm

Peso unit.: 0,238kg



## LC200

### Lancheira de silicone com talheres e molheiro

Dimensões: 18,5x16x0,7cm

Peso unit.: 0,325kg







### **GC1050**

#### **Guarda-chuva invertido cabo plástico haste metal**

Comprimento do produto fechado: 82cm

Diâmetro do produto aberto: 110 cm

Peso unit.: 0,620kg

## GUARDA-CHUVA



### GC1010

#### Guarda-chuva cabo plástico e haste metal

Dimensão Produto Fechado: 24x4cm

Dimensão do Produto Aberto: 95cm

Peso unit.: 0,200kg



### GC1040

#### Guarda-chuva automático com botão acionador

Dimensão do produto: Fechado: 28,5cm.

Dimensão do produto: A0berto: 95cm

Peso unit.: 0,345kg



### GC1000

#### Guarda-chuva cabo de madeira haste metal

Dimensão Produto Fechado: 53xØ5cm

Dimensão Produto Aberto: 120cm

Peso unit.: 1,000kg



### GC1060

#### Guarda-chuva

Dimensões: 84xØ110cm

Peso unit.: 0,440kg



Presentes  
para todos os  
Momentos



# ANIVERSÁRIOS

---

Kit para Petisco e Champagne Conta com petisqueira formato de trevo em Bambu; duas taças para champagne em Vidro; espaço para garrafa com palha. Estão perfeitamente acomodados em uma caixa para presentear.



Kit para Petisco. Conta com tábua redonda com sulco e duas espátulas 14cm em Bambu; dois ramekins, um pequeno e um mini em Porcelana. Estão perfeitamente acomodados em uma caixa para presentear.

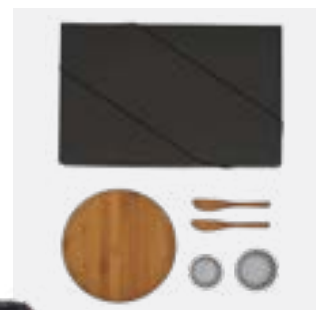

Jogo com 2 taças de Vidro para Champagne, com espaço para a garrafa grande. Capacidade: 190ml. Utilidade do Produto: Ideal para brindar os melhores momentos



Jogo com 2 Taças de Vidro para Vinho. Capacidade: 490ml. Utilidade do Produto: Ideal para brindar os melhores momentos.





# ANIVERSÁRIOS

---

Jogo com 2 Taças de  
Vidro para Gin.  
Capacidade: 600ml  
cada



Copo de Vidro para  
Cerveja/Drinks.  
Capacidade: 200ml



Caneca em cerâmica  
branca com capacidade  
total de 270 ml



Porta-retrato em  
alumínio fosco.  
Conta com vidro  
frontal, apoio em  
polipropileno preto  
e uma fina espuma  
no interior para  
acomodar melhor  
a foto. Pode ser  
usado na vertical ou  
horizontal, tanto na  
parede quanto na  
superfície. Ideal para  
fotos 10x15cm com  
área útil visível de  
9x13cm



# ESCRITÓRIO / HOME OFFICE

---

Caneca em Aço Inox  
com revestimento  
de Poliestireno  
branco e tampa  
em Polipropileno.  
Capacidade: 400 ml



Caneca em Fibra de  
Bambu/PP. Conta  
alça para melhor uso.  
Capacidade: 350 ml





Caneca em polipropileno preto e revestida em aço inox escovado. Possui tampa rosqueável com trava de abertura e anel interno em silicone para vedação. Capacidade: 410 ml  
MATERIAL ATÓXICO  
- TESTADO E APROVADO.



Copo em Fibra de Bambu / PP. Conta com tampa e abertura para beber o líquido. Capacidade: 450 ml



Bolsa Térmica preta em Polyester 600D/PEVA - não impermeável. Conta com alça ajustável, bolso frontal e fechamento em zíper. Forro interno cinza feito de PEVA. Tempo de Conservação aproximado: Frio 10 horas / Quente 3 horas.



Bolsa Térmica preta em Polyester 600D, 300D e PEVA. Conta com alças de mão, alça de ombro, bolso frontal com zíper, dois bolsos laterais com zíper, elástico superior trançado. Forro interno branco feito de PEVA, atóxico e mais sustentável que o PVC. Tempo de Conservação aproximado: Frio 10 horas / Quente 3 horas.



Kit para Churrasco e Cerveja. Acompanha tábua com três furos em Bambu; faca 8" e garfo em Bambu/Inox; seis copos de cerveja em Vidro; caixa para truco com marcador de tentos e jogos em MDF; jogo de cartas.

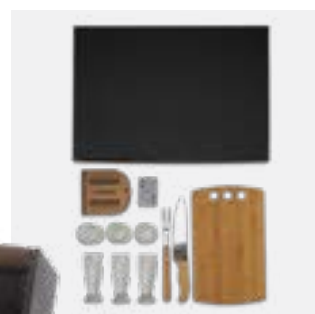

Conjunto para Churrasco / Cerveja / Truco. Acompanha tábua com três furos em Bambu; faca 8" e garfo em Bambu/Inox; quatro copos de cerveja em Vidro; caixa para truco com marcador de tentos e jogos em MDF; jogo de cartas. Como cortesia, na faca 8" fazemos uma gravação com os cortes do boi.

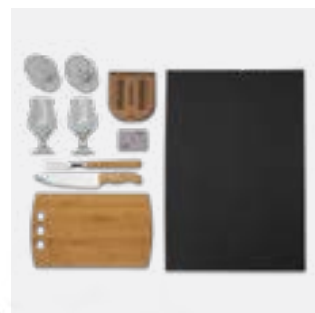



Canivete  
confeccionado em  
aço inox com cabo  
emborrachado  
antiderrapante,  
trava em metal e  
furo no cabo para  
argola. Acompanha  
bainha em couro  
com acabamento em  
costura lateral, aba  
traseira para cintos  
e fechamento com  
lingueta e botão de  
pressão. Disponível  
também sem bainha.



Mochila em polyester para notebook 15", compartimento externo com zíper, um bolso interno e três bolsos externos; Um deles com divisória em tela elástica. Também conta com costas acolchoadas e alças ajustáveis, dois detalhes frontais cromados para saída de ar e orifício superior para saída de fones de ouvido.



Mochila confeccionada em polyester, possui um compartimento interno para notebook 15", alça de mão, dois bolsos externos nas laterais em tela elástica e um frontal com zíper. Também conta com alças ajustáveis para as costas e zíper com duplo cursor na abertura principal.



# VIAGEM

---

Mochila preta confeccionada em Poliéster 600D. Conta com um bolso frontal, dois bolsos laterais em tela elástica e alças ajustáveis. Possui ainda alça de mão e zíper com duplo cursor na abertura principal. Capacidade: 20 litros



Mochila azul em Poliéster 600D/1680D com alças para as costas, alça para as mãos, compartimento para notebook de até 15", 3 bolsos externos com zíper e 2 bolsos externos em tela. Utilidade do Produto: Uma mochila ideal para quem precisa de conforto, praticidade e organização no trabalho, nas viagens e no dia a dia.



Preto  
Azul





Bolsa Térmica preta em Polyester 600D, 300D e PEVA. Conta com alças de mão, tampa com zíper duplo cursor e bolso frontal com zíper. Tempo de Conservação aproximado: Frio 10 horas / Quente 3 horas.



Mochila preta em Poliéster 600D/1680D com alças para as costas, alça para as mãos, compartimento para notebook de até 15", 3 bolsos externos com zíper e 2 bolsos externos em tela.

■ Preto  
■ Azul



# CHURRASCO

Kit para Churrasco, Petisco e Cerveja com tábua três furos e duas espátulas em Bambu; faca 7" e garfo em Bambu/Inox; dois ramequins em Porcelana; quatro taças de cerveja em Vidro. Como cortesia, na faca 7" fazemos uma gravação com os cortes do boi.



Conjunto para Churrasco / Cerveja / Whisky Conta com tábua para churrasco com sulco em Bambu; faca 8" e garfo em Bambu/Inox; caneca para cerveja e copo para whiky em Vidro; avental preto em Brim. Estão acomodados em uma caixa para presentear.



Kit para churrasco e cozinha. Conta com tábua para cozinha, tábua para churrasco; faca 8", faca 7", faca 7" para frios, faca 7" para pão, cutelo 6", faca 5" para desossar, faca 4" para frutas, faca 3" para legumes, chaira e garfo em Bambu/Inox em uma caixa para presentear. Como cortesia, na faca 8" fazemos uma gravação com os cortes do boi.



Kit para churrasco e petisco. Acompanha tábua com três furos e duas espátulas em Bambu; faca 7" e garfo em Bambu/Inox; faca em Aço Inox; dois ramequins. Tábua confeccionada com tripla camada invertida, para dar maior durabilidade e não deformar com o passar do tempo. Rebites em Aço Inox 304, um dos mais resistentes à ferrugem e corrosão.





# CHURRASCO

Kit para Churrasco em Bambu/Aço Inox com avental e tábua em Bambu com sulco, faca 8", chaira, garfo em Bambu/Inox, pegador 30cm em Bambu e avental com bolso em Brim preto. Como cortesia, na faca 8" fazemos uma gravação com os cortes do boi.

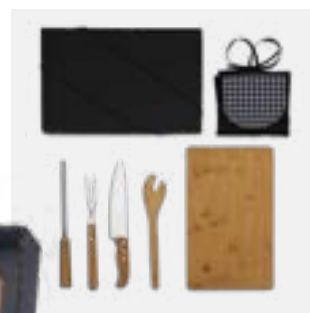

Conjunto para Churrasco em Bambu/Aço Inox. Acompanha tábua em Bambu com sulco, faca 7", faca 5" para desossar e garfo em Bambu/Inox. Acomodados em uma linda caixa para presente. Como cortesia, na faca 7" fazemos uma gravação com os cortes do boi.

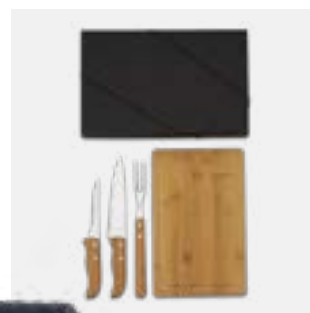

Kit para churrasco. Conta com faca 8", garfo 4 dentes e garfo trinchante em Bambu/Inox; avental em Brim. Faca e garfo trinchante em Aço Forjado AISI420.

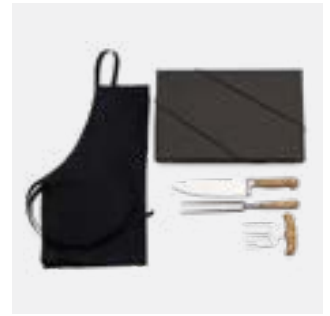

Kit contendo tábua com três furos em Bambu; faca 8" e garfo em Bambu/Inox; dois copos de cerveja, dois copos de whisky e dois copinhos de dose em Vidro; caixa para truco com marcador de tentos e jogos em MDF; jogo de cartas. Como cortesia, na faca 8" fazemos uma gravação com os cortes do boi.

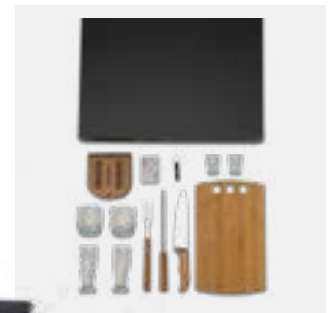

# CHURRASCO

Kit para churrasco. Conta com tábua em bambu; faca 8" e garfo em aço inox / bambu. Tábua confeccionada com tripla camada invertida, para dar maior durabilidade e não deformar com o passar do tempo. Rebites em Aço Inox 304, um dos mais resistentes à ferrugem e corrosão.



Kit para churrasco. Conta com tábua em Bambu; faca 8" e garfo 4 dentes em Bambu/Inox. Tábua confeccionada com tripla camada invertida, para dar maior durabilidade e não deformar com o passar do tempo. Rebites em Aço Inox 304, um dos mais resistentes à ferrugem e corrosão.

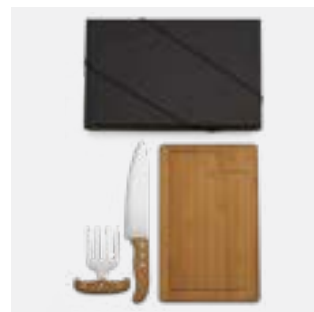



Conjunto para Churrasco em Bambu / Aço Inox. Conta com tábua em Bambu; faca 8" e garfo em Bambu/Inox. Laminas forjadas Aço AISI420.



Conjunto composto por uma tábua retangular em bambu com sulco, uma faca 7" e um garfo trinchante, ambos com cabo em madeira e lâmina em aço inox com rebites resistentes. Produto ecológico e ideal para empresas ou ações que buscam transmitir mensagens relacionadas à sustentabilidade.



# CHURRASCO

---

Garfo 4 dentes em  
Inox / Bambu.



---

Conjunto composto  
por quatro copos  
em vidro do tipo  
Lager de 200ml,  
perfeitamente  
acomodados em  
uma caixa kraft com  
tampa. Ideal para  
chopes ou cervejas  
do tipo Pilsen.



---

Conjunto contendo  
duas caneca de  
vidro para chopp  
ou cerveja com  
capacidade de 340  
ml cada.



Kit de Faca 8" em Bambu/Aço Inox, chaira e garfo em Bambu/Inox. Utilizamos o Bambu, por ser uma matéria prima ecológica, autossustentável e com alta resistência. Além de versátil, o Bambu é 30% mais leve que as madeiras de lei. Sua utilização não agride o meio ambiente, pois, quando ceifado rebrota em pouco tempo.



Conjunto composto por uma faca 7" com a gravação dos cortes do boi na lâmina e um garfo trinchante, ambos com cabos em madeira e lâminas em aço inox com rebites resistentes; Estão organizados em uma caixa kraft para presente.



Conjunto Barbecue em Bambu/Aço Inox com cabo longo. Acompanha faca para Churrasco, pegador para Churrasco, espátula para Churrasco e garfo para Churrasco em Bambu/Inox. Todas as peças têm o cabo longo, especialmente para facilitar o preparo do seu Churrasco.





# CHURRASCO

---

Caneca de Vidro para Chopp ou cerveja.  
Capacidade: 340 ml  
Utilidade do Produto: Ideal para brindar os melhores momentos.



Jogo com dois copos em vidro.  
Capacidade: 300ml cada.



Jogo com 2 Copos de Vidro para Cerveja/ Drinks.  
Capacidade: 400ml cada  
Utilidade do Produto: Ideal para brindar os melhores momentos.



Kit para Queijo e Vinho com tábua para queijo e petiscos, duas facas, sendo uma com ponta e outra reta, garfo e espátula em Bambu/Inox; duas taças para vinho em Vidro; abridor e tampão em Metal; espaço para garrafa com palha. Estão perfeitamente acomodados em uma caixa para presentear.



Kit para Queijo e Vinho Conta com tábua para queijo/ petisco; duas facas, sendo, uma com ponta e outra reta, garfo e espátula em Bambu/Inox; duas taças para vinho em Vidro; abridor em Metal. Estão perfeitamente acomodados em uma caixa para presentear.



Kit para Queijo e Vinho Conta com tábua redonda para queijo/petisco e 4 espetinhos em Bambu; duas taças para vinho em Vidro; abridor em Metal. Estão perfeitamente acomodados em uma caixa para presentear.

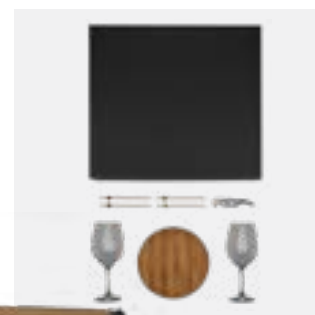

Conjunto para queijo em Bambu / Inox. Acompanha tábua e cepo em Bambu; garfo, faca sem ponta, faca com ponta e faca quadrada em Aço Inox 2CR13.

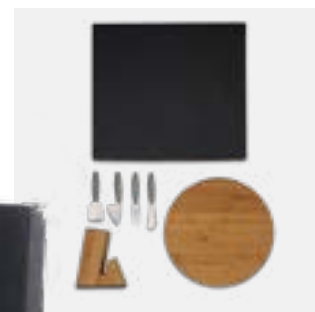



Kit caipirinha com tábua em Bambu, faca para frutas 4" em Inox/Bambu, pilão, colher de 18cm e base para a tábua em Bambu e coqueteleira de 350ml em Aço Inox. Acomodados em uma linda caixa para presente.



Kit para caipirinha. Conta com tábua e socador em bambu; copo de vidro 350ml; faca para frutas de 4" em aço inox. Produto ecológico e ideal para transmitir mensagens relacionadas à sustentabilidade e à cultura nacional.



# RECEBER EM CASA

Kit em Inox e bambu com uma coqueteleira de 350ml em aço inox escovado com acabamento externo brilhante, faca para frutas de 4", colher em bambu de 18cm, coador em aço inox, abridor saca-rolhas modelo sommelier de alavanca simples, pegador de gelos, socador/pilão e uma tábua pequena.

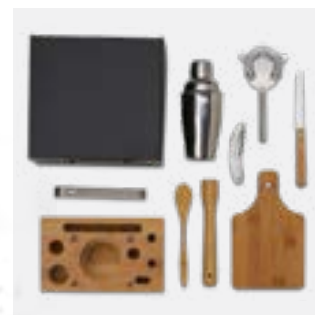

Kit para whisky e jogos. Conta com dois copos para whisky, baralho, caneta esferográfica e bloco para anotações. Estão perfeitamente acomodados em uma caixa para presentear.



Jogo com 4 Copos de Vidro para Cerveja/ Drinks. Capacidade: 400ml cada Utilidade do Produto: Ideal para brindar os melhores momentos.



Kit para Queijo e Cerveja Conta com tábua para queijo/petisco; faca para frios em Metal; dois copos para cerveja em Vidro. Estão acomodados em uma caixa para presentear.





# RECEBER EM CASA

Kit para Petisco com petisqueira em formato de coração e duas espátulas 14cm em Bambu; dois ramekins, um pequeno e um mini em Porcelana. Estão perfeitamente acomodados em uma caixa para presentear.



Kit para cafézinho. 4 xícaras com pires em Porcelana; 4 colheres em inox.



Conjunto de facas em Aço Inox para queijos. Acompanha garfo, faca sem ponta, faca com ponta e faca quadrada em Aço Inox 2CR13.



Petisqueira em Bambu com formato de trevo de 4 folhas. Conta com 4 divisões.



Kit para queijo. Conta com tábua redonda em bambu; três facas e garfo para queijos. Tábua confeccionada com tripla camada invertida, para dar maior durabilidade e não deformar com o passar do tempo.



Conjunto para Pizza em Bambu/Aço Inox. Acompanha tábua e espátula em Bambu; quatro facas de mesa, quatro garfos de mesa e cortador de Pizza em Bambu/Inox. Embalagem ideal para presentear.



Kit para queijo. Conta com tábua redonda e suporte em bambu; três facas e garfo para queijos. Tábua confeccionada com tripla camada invertida, para dar maior durabilidade e não deformar com o passar do tempo.

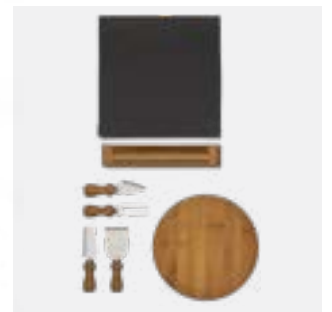

Conjunto para queijo em Bambu / Inox. Acompanha tábua em Bambu; garfo, faca sem ponta, faca com ponta e faca quadrada em Aço Inox 2CR13. Produto ecológico e ideal para empresas ou ações que buscam transmitir mensagens relacionadas à sustentabilidade.





Conjunto para Queijo em Bambu / Inox. Conta com tábua em Bambu; faca com ponta e garfo para queijo em Bambu / Inox. Tábua confeccionada com tripla camada invertida, para dar maior durabilidade e não deformar com o passar do tempo.



Conjunto para Pizza em Bambu/Aço Inox. Acompanha tábua e espátula em Bambu e cortador de Pizza em Bambu/Inox. Embalagem ideal para presentear.

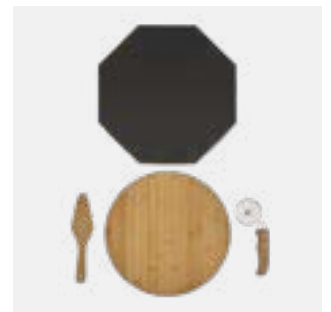

Conjunto para Pizza em Bambu/Aço Inox. Acompanha tábua em Bambu; cortador de Pizza em Bambu/Inox.



# RECEBER EM CASA

---

Petisqueira giratória em Bambu. Conta com seis divisórias, com placas removíveis, e um bowl para molhos e patê



Conjunto para petiscos e patês em Bambu/Fibra de Bambu. Acompanha dois potes em Fibra de Bambu, base e duas espátulas 14cm em Bambu. Utilizamos o Bambu, por ser uma matéria prima ecológica, autossustentável e com alta resistência. Além de versátil, o Bambu é 30% mais leve que as madeiras de lei.



Conjunto para petisco em Bambu/Fibra de Bambu. Acompanha cinco potes em Fibra de Bambu; quatro garfos em Aço Inox com ponta em formato de azeitona; base em Bambu com alças em Aço Inoxidável.



Caixa para Chás em Bambu/Poliestireno. Possui 6 divisões e tampa com visor em Poliestireno. Não acompanha chás.



Composto por cinco acessórios para vinho em metal e inox, sendo um anel corta-gotas, um funil direcionador com tampa e tampão, ambos com detalhes emborrachados para melhor fixação na garrafa, um termômetro e um abridor saca-rolhas modelo sommelier de alavanca simples com três funções acomodados em um estojo em bambu.



Abridor saca-rolhas em aço inox escovado. Conta com agulha espiral saca-rolhas, uma lâmina canivete de 1" com serra para cortar lacres e abridor de garrafas com duas bases de apoio.





# COZINHAR E SERVIR

---

Avental em brim preto. Conta com um bolso frontal, tiras para amarrar na cintura e pescoço com regulagem de altura.



Conjunto composto por uma faca 7" com a gravação dos cortes do boi na lâmina, um garfo trinchante, ambos com cabos em madeira e lâminas em aço inox com rebites resistentes e uma colher em bambu 30cm; Estão organizados em uma caixa kraft para presente.



Faca de 7 polegadas em aço inox com cabo em bambu, conta com design anatômico e patenteado, possui lâmina em aço inox e dois rebites em aço inox 304, um dos mais resistentes à ferrugem e corrosão. Produto ecológico e ideal para empresas ou ações que buscam transmitir mensagens relacionadas à sustentabilidade.



Conjunto para cozinha em Bambu / Inox. Acompanha tábua com 3 furos e cepo em Bambu; faca 7", faca para pão 7", faca para frutas 4" e faca para legumes 3".



Conjunto para Cozinha/Pão em Bambu/Aço Inox. Acompanha tábua com sulco para aparar migalhas e colher 30cm em Bambu; faca 7", faca 7" para pão, faca 3" para legumes em Aço Inox/Bambu. Acomodados em uma linda caixa para presente. Tábua confeccionada com tripla camada invertida, para dar maior durabilidade.

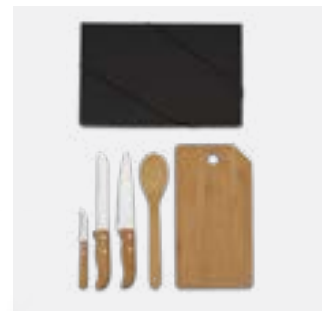

# COZINHAR E SERVIR

---

Tábua para Cozinha em Bambu em formato de coração. Confeccionada com tripla camada invertida, para dar maior durabilidade e não deformar com o passar do tempo.



Tábua para Cozinha em Bambu em formato de porco. Confeccionada com tripla camada invertida, para dar maior durabilidade e não deformar com o passar do tempo.



Tábua para churrasco / cozinha em bambu. Conta com sulco ao redor da tábua. Confeccionada com tripla camada invertida, para dar maior durabilidade e não deformar com o passar do tempo.





Kit para Churrasco. Acompanha tábua em Bambu; faca 7", faca santoku e espátula multiuso em Bambu/Inox; avental em Brim. Tábua confeccionada com tripla camada invertida, para dar maior durabilidade e não deformar com o passar do tempo. Rebites em Aço Inox 304, um dos mais resistentes à ferrugem e corrosão.



Kit para cozinha Acompanha tábua e colher 30cm em Bambu; espátula multiuso em Bambu/Inox. Acomodados em uma linda caixa para presente. Tábua confeccionada com tripla camada invertida, para dar maior durabilidade e não deformar com o passar do tempo. Rebites em Aço Inox 304, um dos mais resistentes à ferrugem e corrosão.



# COZINHAR E SERVIR

Kit Matinal Conta com duas canecas em Cerâmica; duas tigelas e pote em Vidro; duas colheres em Bambu. Capacidade das canecas: 270ml cada.

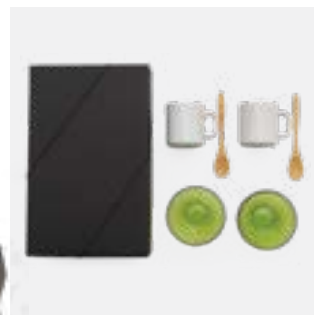

Conjunto para Patê / Geléia. Conta com 2 potes de vidro com tampa; 2 espátulas em Bambu.



Tábua para churrasco / cozinha em bambu. Conta com sulco ao redor da tábua. Confeccionada com tripla camada invertida, para dar maior durabilidade e não deformar com o passar do tempo.



Moedor de sal grosso e pimenta em bambu e aço inox. Conta com haste interna em alumínio e mecanismo em cerâmica.



Moedor de sal grosso e pimenta em bambu. Conta com haste interna em alumínio e mecanismo em cerâmica.





# COZINHAR E SERVIR

---

Bandeja para servir em Bambu. Conta com alças para melhor uso. (imagem ilustrativa, não acompanha outros produtos)



Conjunto para salada em bambu com pegador de 30cm. Utilizamos o Bambu, por ser uma matéria prima ecológica, autossustentável e com alta resistência. Além de versátil, o Bambu é 30% mais leve que as madeiras de lei. Sua utilização não agride o meio ambiente, pois, quando ceifado rebrota em pouco tempo.



Porta-guardanapos em Bambu. Conta com uma esfera em metal cromado, para segurar os guardanapos.



Conjunto de Utensílios de 30cm em Bambu, composto por colher, colher perfurada, espátula perfurada, espátula reta e porta utensílios.



Colher em bambu. Conta com 30cm de comprimento, cabo com furo para pendurá-la em ganchos e facilitar seu uso e caixa para presentear.



Espátula multiuso em Bambu / Inox. Conta um leve fio de corte.



# COZINHAR E SERVIR

---

Porta-condimentos em bambu / vidro. Conta com seis recipientes com capacidade para 100ml em vidro; base giratória em bambu.



Amassador de temperos em Bambu. Conta com base e socador.



Farinheira em Bambu. Conta com cumbuca, tampa e colher.







☎ 54 3311-4763

📞 54 99112-2995

✉ contato@eduardopersonalizados.com.br



Visite  
nosso  
Site



Fale ao vivo  
com um  
Especialista

